

General Description

The AP3301 EV1 board is a Quasi-Resonant Flyback converter, operating under CCM and DCM, the valley switching on mode function will be appeared at all DCM region of variable load & high input AC line voltage conditions, it is employed with the peak-current control & multi-mode PWM control functions. Based on above the high performances are optimized & achieved. It is designed to serve as an example for High Efficiency, cost-effective & components less consumer home appliance systems. Its output power is rated at 42W with 12V-3.5A and peak power can be reach to 48W at peak time. Its input power consumption is less than 100mW at no load and meets DOE VI and CoC Tier 2 energy efficiency requirement.

Key Features

- 90 ~265V_{AC} input range
- Multi-Mode PWM method operation & QR valley switching cover full range of AC input at heavy load, the switching frequency between 20Khz ~120Khz.
- With Valley Switching Turn on function that improving power converting efficiency, the 90% Efficiency can be reached.
- During the burst mode operation the 100mW low standby input power can be achieved.
- Dynamic response is improved during work at three mode operation.
- Low start-up operating and low quiescent currents at turn on moment.
- Soft start during startup process.
- Provide accurate constant voltage regulation & accurate constant current (CC) regulation.
- Frequency fold back for high average efficiency
- Built-in Jittering Frequency function is built in to reduce EMI emission.
- Valley-on Soft Switching for Reducing EMI.
- Internal Auto Recovery OCP, OVP, OLP, OTP Power Protection, cycle by cycle current limit, also with DC polarity protection
- With a Brown out Protection.

Applications

- Switching AC-DC Adaptor & Charger
- Power home Appliances systems
- Set-top box & TV power supply
- Open frame switching power supply

Universal AC input QR 12V-3.5A Power Specifications (CV & CC mode)

Parameter	Value
Input Voltage	90 to 265V _{AC}
Main output Vo / Io	12V – 3.5A
Standard power	Less than 100mW
Efficiency	>89%
Total Output Power	42W
Protections	OCP, OVP, OLP,OTP
XYZ Dimension	76.0 x 50.4 x 22 mm
ROHS Compliance	Yes

Evaluation Board Picture:

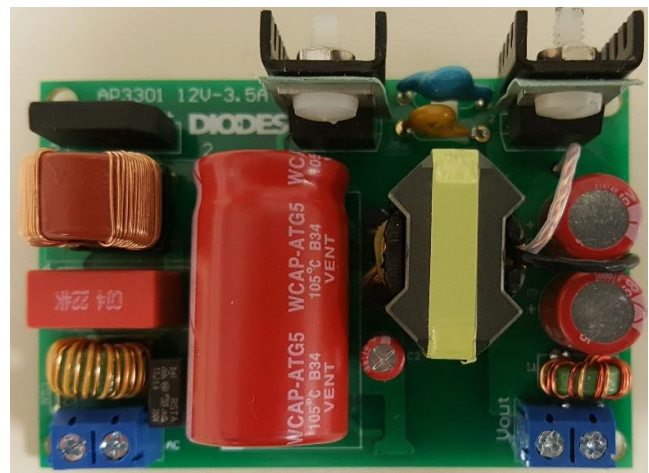

Figure 1: Top View

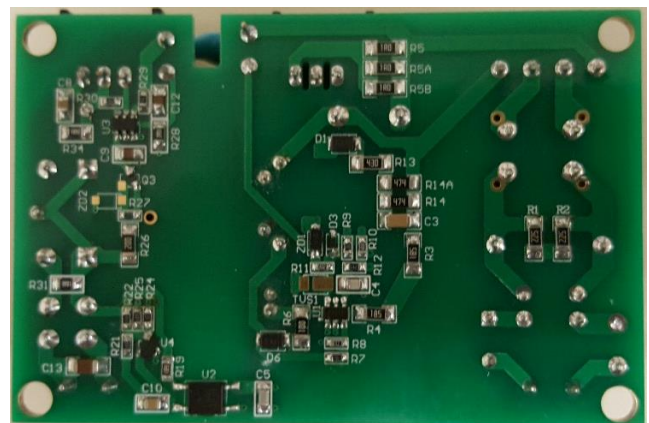
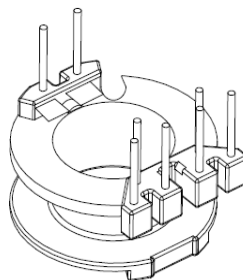
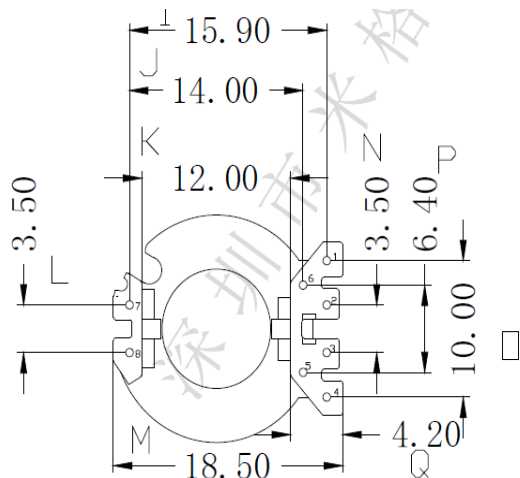

Figure 2: Bottom View

AP3301 (90V_{AC} ~ 265V_{AC} one output 42W Transformer Spec.)

1) Core & Bobbin: RM8 , 6+2 pin



2) Electrical Diagram:

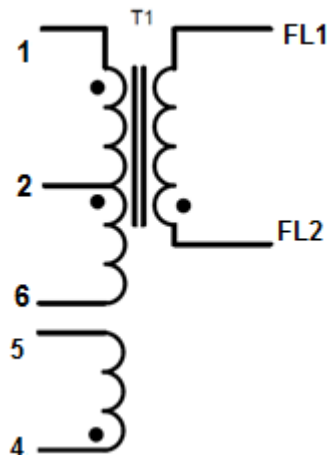

3) Transformer Parameters

1. Primary Inductance (Pin2-Pin1), all other windings are open
L_p = 0.7mH ±5% @1KHz

RM8 (A _e = 64mm ²)						
NO Winding	NAME	TERMINAL NO.		WINDING		
		START	FINISH	WIRE	TURNS	Layers
1	Np1	1	2	Φ 0.35 (27# AWG)	21 x 2= 42Ts	2
2	Na	4 (Gnd)	5	Φ 0.2*3	9 Ts	1
3	Shield	4 (GND)	NC	Φ 0.2* 2	(均匀分布)	1
4	Ns	FL2 (G) 顶部飞线	FL1 (+) 顶部飞线	Φ 0.5W *2 (24# AWG)	7 Ts	1
5	Np2	2	3	Φ 0.35 (27# AWG)	20	1
Primary Inductance		Pin 3-1,all other windings open, measured at 1kHz, 0.4VRMS			650~700uH±5%	
Primary Leakage Inductance		Pin 3-1, all other windings shorted, measured at 10kHz, 0.4VRMS			20 uH (Max.)	

Evaluation Board Schematic

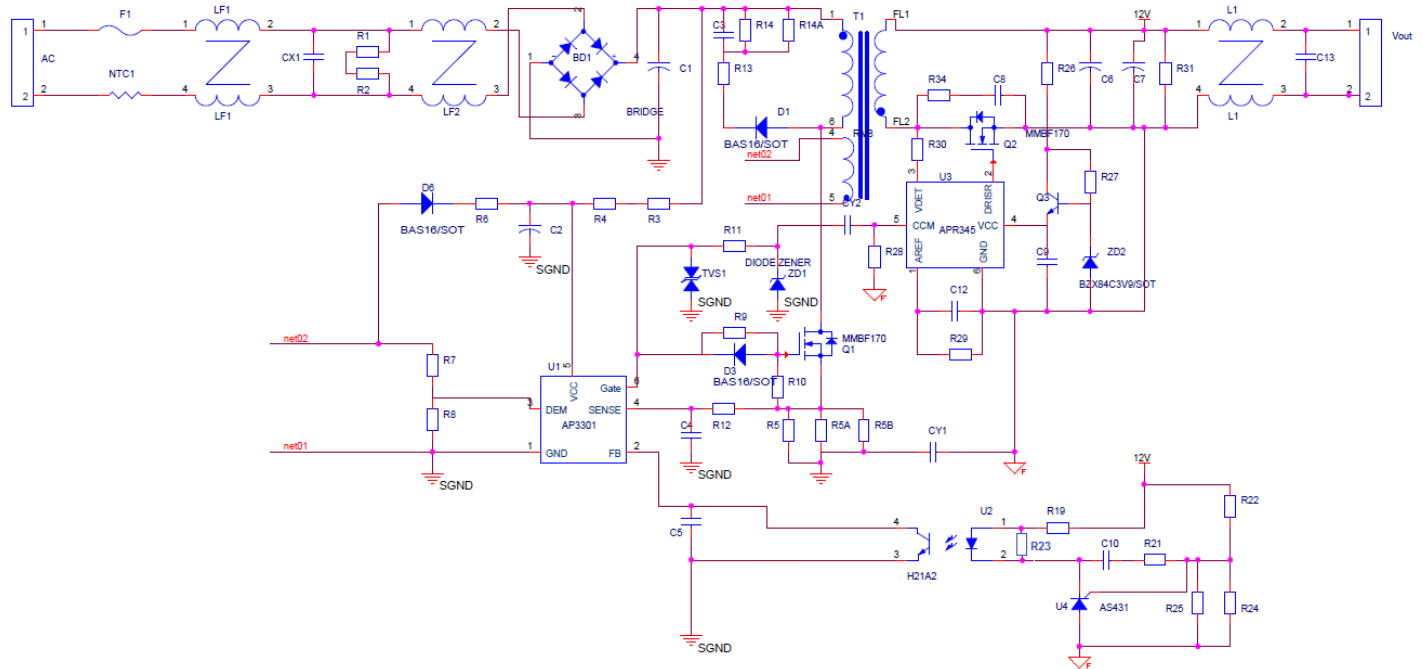

Figure 3: Evaluation Board Schematic

Evaluation of PCB Board Layout

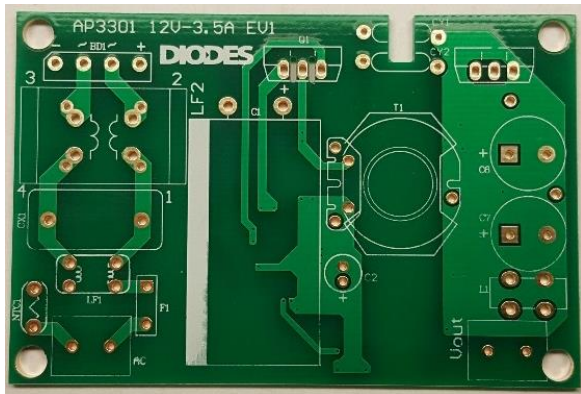

Figure4: PCB Board Layout Top View

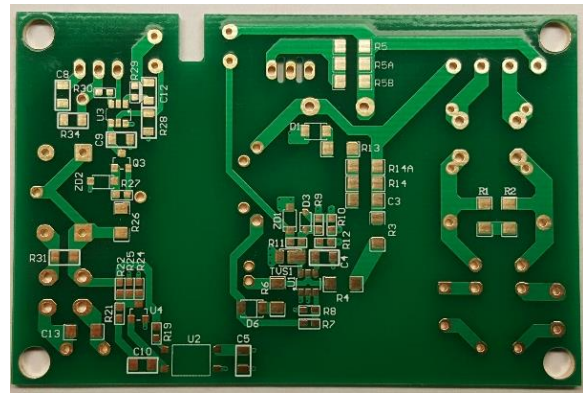

Figure5: PCB Board Layout Bottom View

Quick Start Guide

1. The evaluation board is preset at 12V/3.5A from output side of Block Terminal TH1 ~TH2
2. Ensure that the AC source is switched OFF or disconnected.
3. Connect the AC line wires of power supply to "L and N" on the AC side of Block Terminal.
4. Turn on the AC main switch.
5. Measure TH1~TH2 Block Terminal pins voltage to ensure correct output voltages at 12V

Build of Material

AP3301 42W SYSTEM BOM - 10/15/2018 with schematic

Item No	Item	Type	Quantity (Unit)	part number #
1	C1	120uF/420V, AL CAP	1	Wurth 860021381021 18x33mm
2	C2	4.7uF/35V, AL CAP 5x11mm	1	Wurth 860020572002 5 x11
3	C3	2.2nF/500V/1206 ,ceramic	1	Holy Stone
4	C4	100pF/25V, 0805ceramic	1	Wurth - 885012007057
5	C5	470pF/25V,0805,ceramic	1	Wurth - 885012007061
6	C6//C7	680uF/16V, AL CAP	2	Wurth - 870025375009
7	C8	1nF/200V,1206,ceramic	1	Wurth - 885012007063
8	C9 & C12	0.1uF/50v 0805 ceramic	2	Wurth - 885012207098
9	C10	68nF/50V 0805 ceramic	1	Wurth - 885012207097
10	C13	22uf/16V 1206 X5R	1	Holy Stone
11	R1/R2	2.2Mohm,1206	2	Yageo
12	R3/R4	1.8Mohm,1206	1	Yageo
13	R5, R5A,R5B	1R0//1R0//1R6 ohm, 1206	3	Yageo
14	R6	2.2 ohm, 1206	1	Yageo
15	R7	100Kohm,0603	1	Yageo
16	R8	15Kohm,0603	1	Yageo
17	R9	20 ohm 0603	1	Yageo
18	R10	10Kohm,0603	1	Yageo
19	R11	2k ohm, 0603	1	Yageo
20	R12	1.5Kohm, 0603	1	Yageo
21	R13	43 ohm, 1206	1	Yageo
22	R14, R14A	470Kohm,1206	2	Yageo
23	R19 , R27/off	1.0Kohm,0603	1	Yageo
24	R21/R25	12.1Kohm,0603 1%	2	Yageo
25	R22	43.2Kohm,0603	1	Yageo
26	R24	287Kohm,0603 1%	1	Yageo
27	R26	20ohm, 1206	1	Yageo
28	R28 & R31	3.9Kohm,0805	2	Yageo
29	R23	5.1Kohm 0805	1	Yageo
30	R29	100Kohm,0603	1	Yageo
31	R30	20 ohm 0603	1	Yageo
32	R34	18 ohm 0805	1	Yageo
33	CX1	0.22uF/250Vac	1	Wurth 890324024002 15x7mm
34	CY1	1nF/Y1	1	Holy Stone
35	CY2	10pF/Y1	1	Holy Stone
36	U1	AP3301, SOT-6, DIODES	1	Diodes
37	U2	LTV-356T	1	Lite-on SMD
38	U3	APR345,SOT-6, DIODES	1	Diodes
39	U4	AS431,SOT-3, DIODES	1	Diodes SOT-23

40	Q1	DMG10N60SCT DMJ65H600SCTI	1	Diodes
41	Q2	DMT10H10LCT	1	Diodes
		TO220		
42	Q3	MMBT2222A(0Rcross c,e)	off	Diodes SOT-23
43	T1	RM 8, 650uH	1	
44	BD1	GBU406,DIODES	1	Diodes
45	D1	S1MWF, DIODES	1	Diodes
46	D3	IN4148WS Diodes SOD323	1	Diodes
47	D6	S1MWF, DIODES	1	Diodes
48	NTC	SHORT		
49	LF1	9.6*5*4, 7T	1	Part number?
50	LF2	10mH common mode 1A	1	Wurth 744822110 17.5 x 13mm, Holy Stone MOX-VTI-2212-100DSO
51	F1	3.15A/250V	1	
52	L1	10*4*5 100uH	1	Part number?
53	PCB		1	
54	Block connector	Two P	2	OSTTA020161—ED2561-ND#
55	ZD2	DDZ9698 11Vz	off	Diodes SOD123
56	ZD1	DDZ9707 20Vz	1	Diodes SOD123
57	TVS1	DFLT18A	off	Diodes PowerDI123
TOTAL (AP3301)				

Input & Output Characteristics

Input Standby Power

Input Voltage	115Vac/60Hz	230Vac/50Hz	Note
Pin (w)	52mW	75mW	At no loading

Input power Efficiency at different loading

AC input	Efficiency (%)					Eff_avg at four conditions
	10%	25%	50%	75%	100%	
115VAC/60Hz	87.1%	90%	90.1%	89.9%	88.6%	89.65
230VAC/50Hz	84.1%	89.4%	90%	90.3%	90.4%	90%

PSU Output Characteristics:

Line Regulation (at full loading condition):

AC input Voltage	90VAC/60Hz	115VAC/60Hz	230VAC/50Hz	265VAC/50Hz	Note	
Vout	12.00Vo	12.01V/3.5A	12.12V/3.5A	12.13V/3.5A	12.18V/3.5A	0.5%<

Load Regulation (at nominal line AC input voltage):

Load condition	12V/3.5	12V/2.625A	12V / 1.75A	12V / 0.875A	Note
115VAC	12.12V / 3.5A	12.15V/2.625A	12.16V/1.75A	12.17V/0.875A	0.5% <
230VAC	12.13V / 3.5A	12.15V/2.625A	12.16V/1.75A	12.17V/0.875A	0.5% <

OCP Current setting with at different AC line

AC input	90VAC	115VAC	230VAC	264VAC	Note
I_max	4.10A	4.15A	4.28A	4.41A	

Note: All output voltages are measured at output PCB board Edge.

OCP curve with at different AC Input

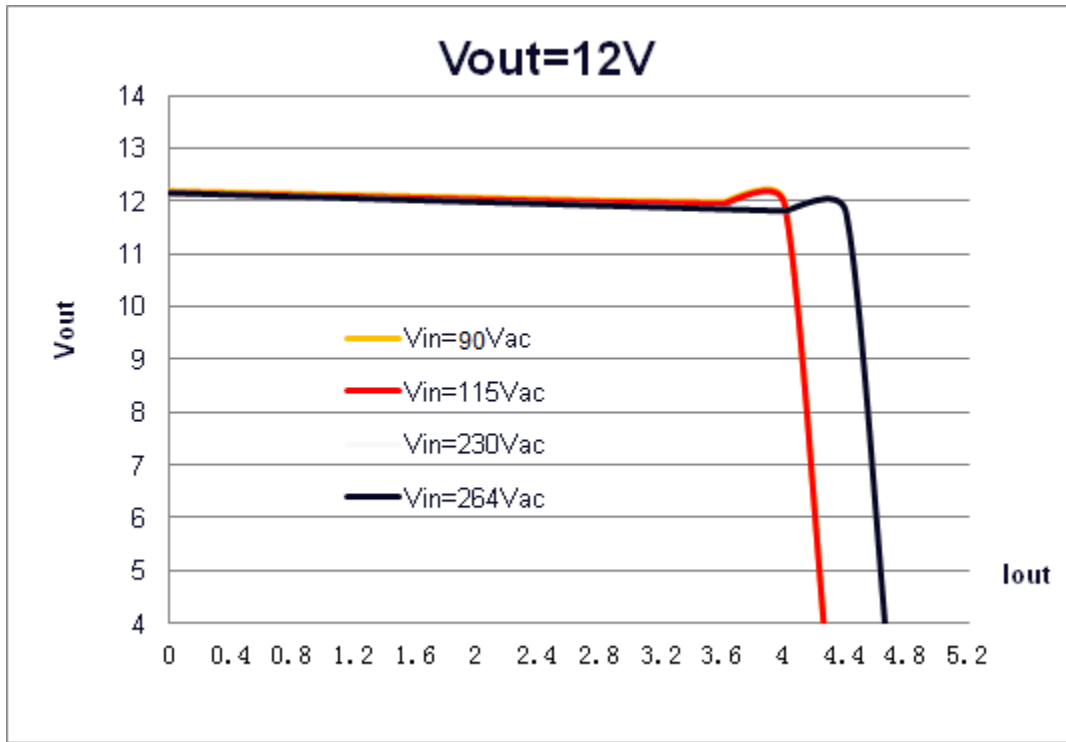

Key Performance Waveforms:

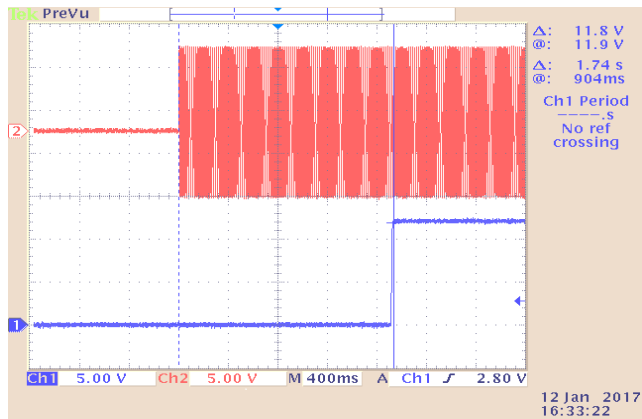

Fig:6 Ton time at full load at 100V_{AC} Ton=1.74s

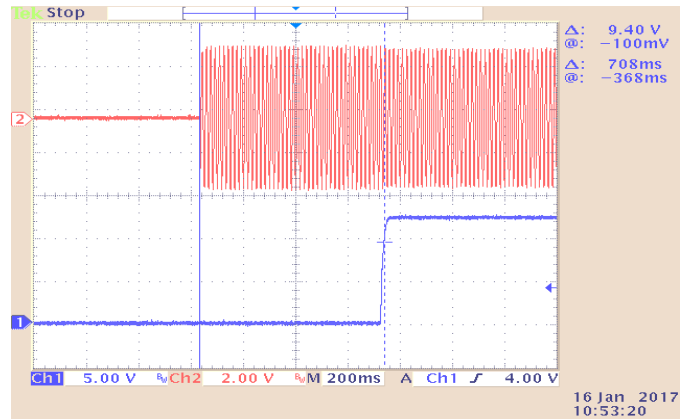

Fig:7 Ton time at full load at 230V_{AC} Ton= 0.708s

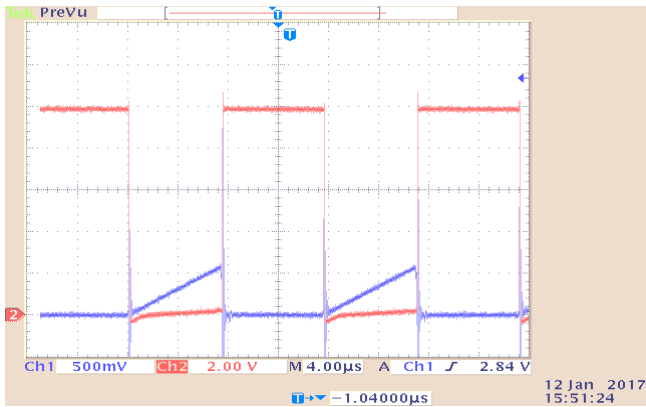

Fig:8 Vds & Vcs Waveform at 100V_{AC} 20V/Div

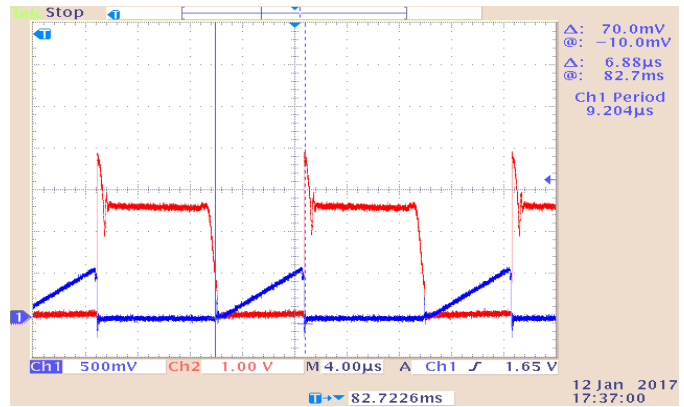

Fig:9 Vds & Vcs at FL at 115V_{ACin} 100V/Div

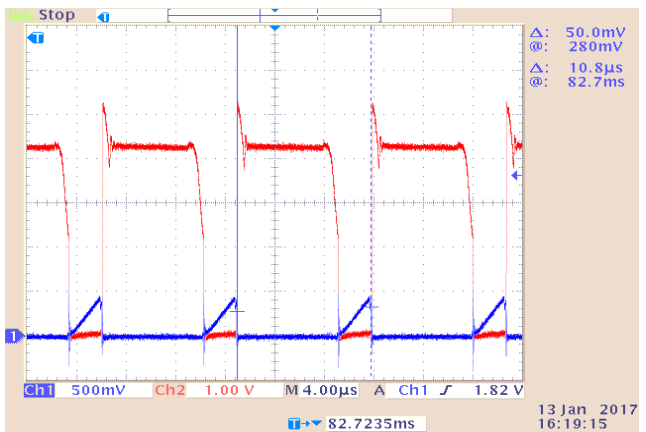

Fig:10 Vds & Vcs at 230V_{ACin} at FL 100V/Div

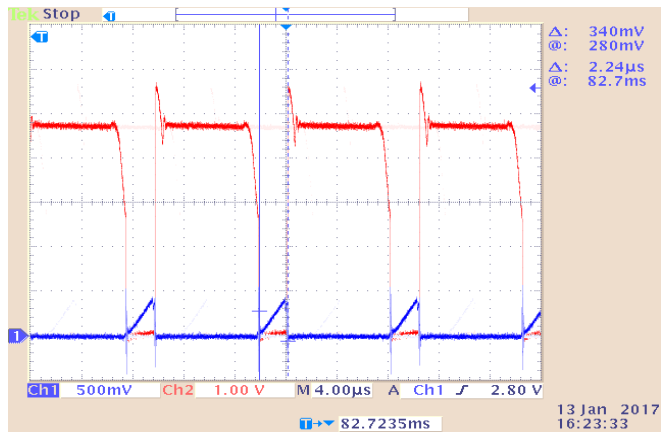

Fig:11 Vds & Vcs at 264V_{ACin} at FL 100V/Div

Output Performance Waveforms

All of the 12V ripple by using a 1:1 Probe in a 100mV/division.

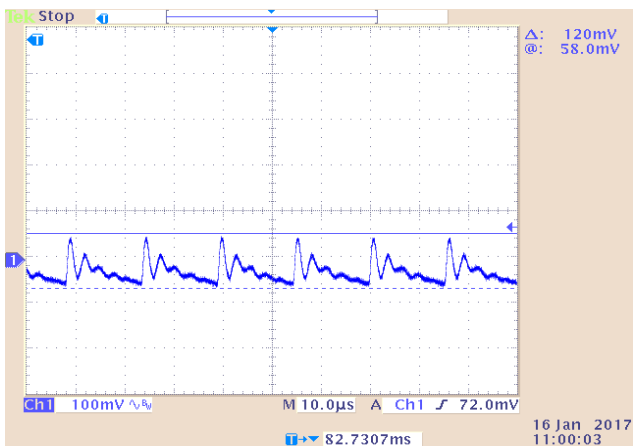

Figure:12 12Vo Vp-p Ripple at 115Vac at FL .

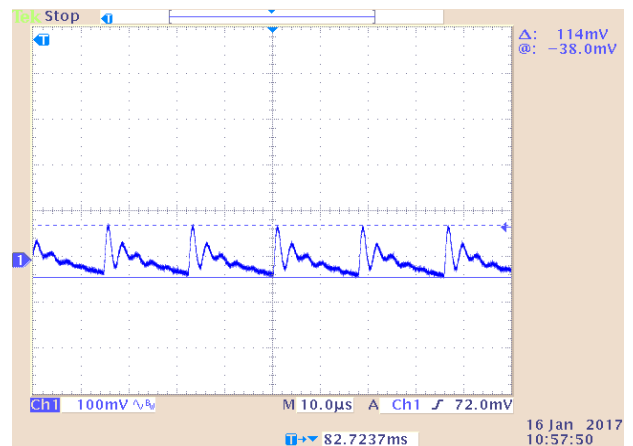

Figure:13 12Vo Vp-p Ripple at 230Vac at FL

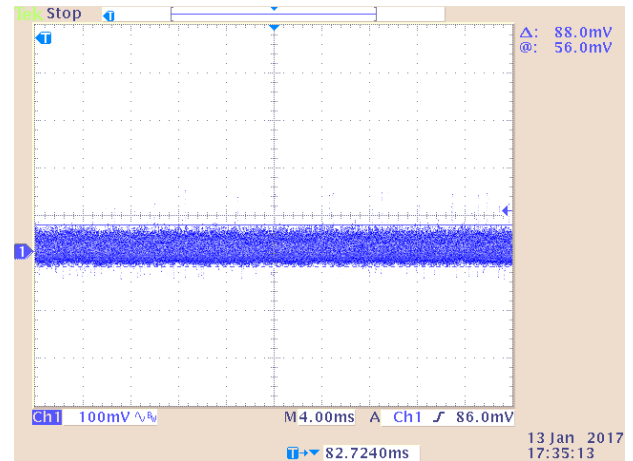
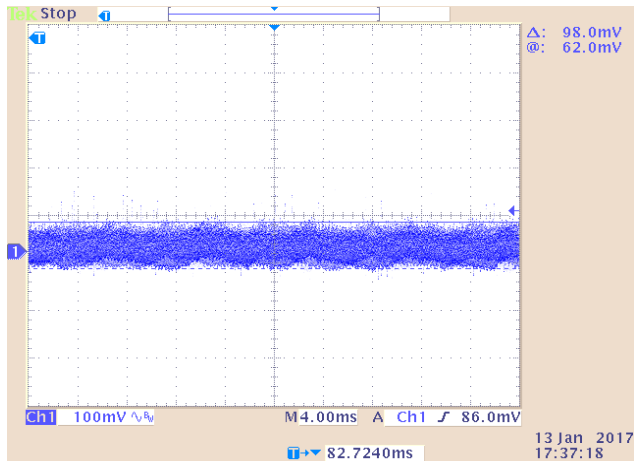

Figure:14 12Vo Ripple at 115Vac at FL

Figure:15 12Vo Ripple at 230Vac at FL

Thermal Test data at room Temperature after running 1 hr

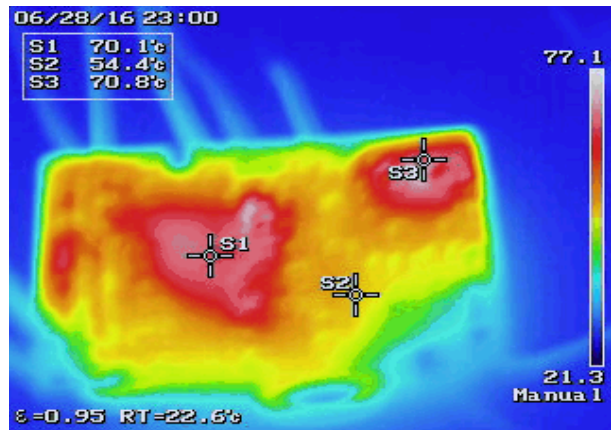
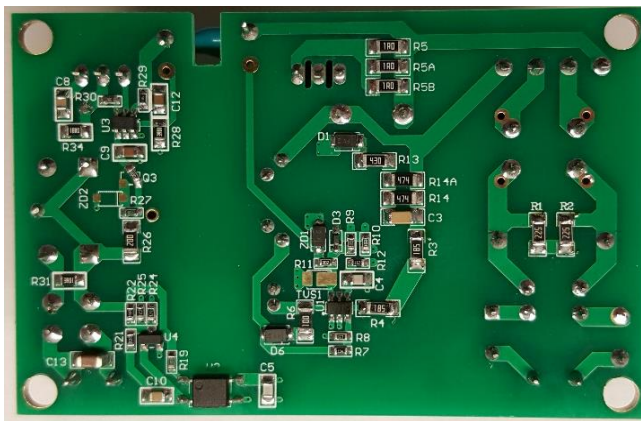

Figure:18 SMD components UP side

Figure:19 SMD side Vin=115V_{AC}, Test time=1hour

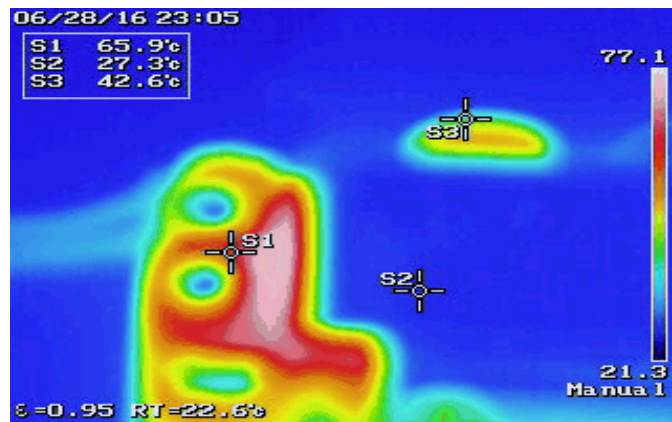
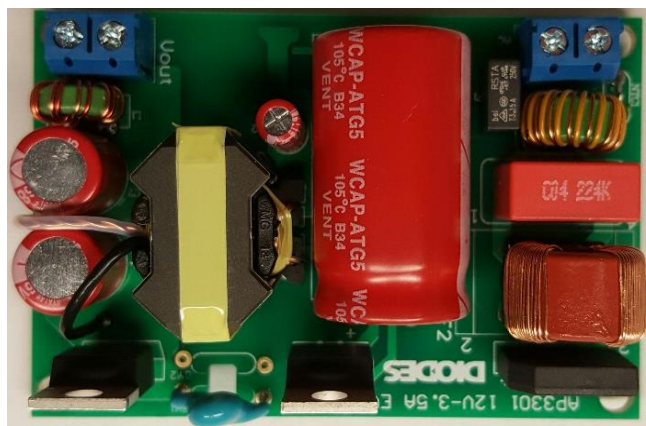
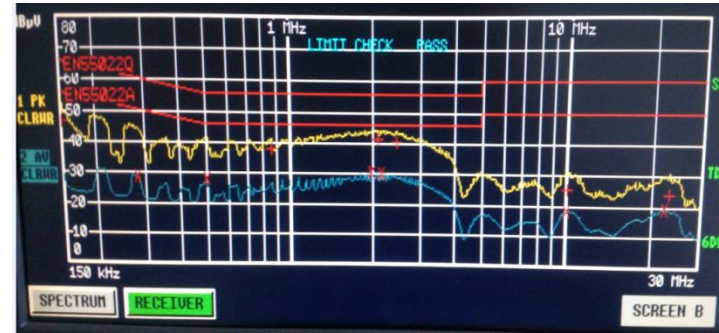

Figure:20 Board Top components side

Figure:21 Vin=115V_{AC}, Testing time = 1.15 hour

The AP3301 12V-3.5A EMC scanned data:

115Vac/60Hz 12V-3.5A Line L



115Vac /60Hz 12V-3.5A Line N

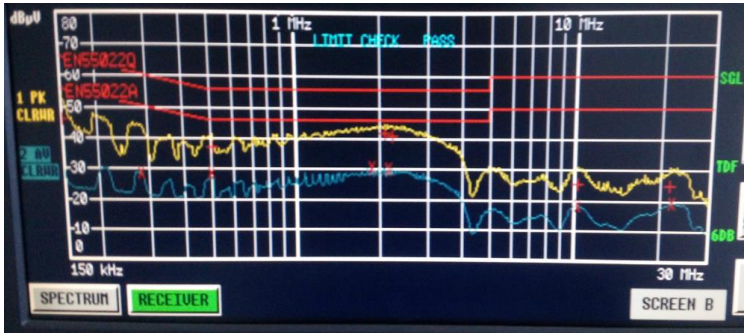

L		N	
QP	AV	QP	AV
-15.42dB	-15.52dB	-14.33dB	-15.32dB

230Vac/50Hz 12V-3.5A Line L

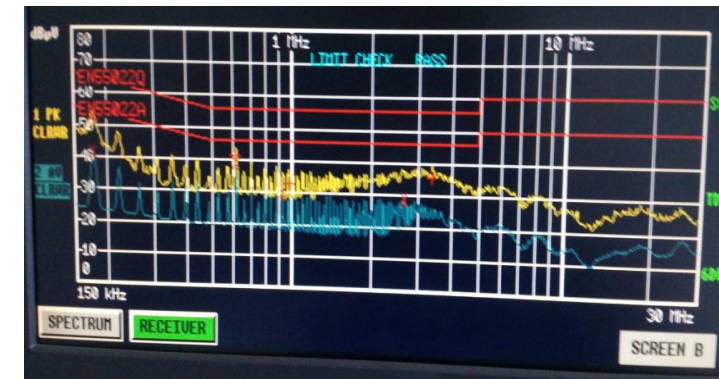

230Vac /50Hz 12V-3.5A Line N

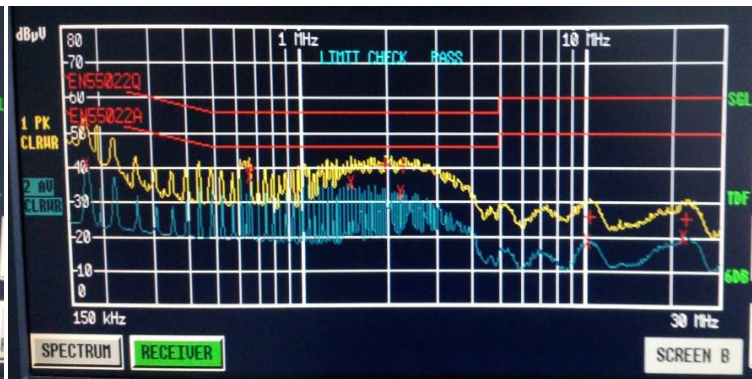

L		N	
QP	AV	QP	AV
-13.01dB	-6.99dB	-12.69dB	-8.19dB

Please see the recommend Application note for reference

(Web page - http://www.diodes.com/appnote_dnote.html)

- 1) For AP3301 operation & set up, please review the Application note:
AN1120 Green Mode PWM Controller
- 2) For PSU PCB layout consideration, please review the App note:
AN1062 High Voltage Green Mode PWM Controller AP3105
- 3) For the basic Flyback topology calculation, please review the App note:
AN1045 Design Guidelines for Off-line AC-DC Power Supply Using BCD. PWM Controller AP3103

- 4) Revision 1.1 charge list
 - a) Add in new alternate Mosfet.
 - b) Add in R23=5.1K for improving load regulation.
 - c) Updated schematic date into 10-15-2018.

IMPORTANT NOTICE

DIODES INCORPORATED MAKES NO WARRANTY OF ANY KIND, EXPRESS OR IMPLIED, WITH REGARDS TO THIS DOCUMENT, INCLUDING, BUT NOT LIMITED TO, THE IMPLIED WARRANTIES OF MERCHANTABILITY AND FITNESS FOR A PARTICULAR PURPOSE (AND THEIR EQUIVALENTS UNDER THE LAWS OF ANY JURISDICTION).

Diodes Incorporated and its subsidiaries reserve the right to make modifications, enhancements, improvements, corrections or other changes without further notice to this document and any product described herein. Diodes Incorporated does not assume any liability arising out of the application or use of this document or any product described herein; neither does Diodes Incorporated convey any license under its patent or trademark rights, nor the rights of others. Any Customer or user of this document or products described herein in such applications shall assume all risks of such use and will agree to hold Diodes Incorporated and all the companies whose products are represented on Diodes Incorporated website, harmless against all damages.

Diodes Incorporated does not warrant or accept any liability whatsoever in respect of any products purchased through unauthorized sales channel.

Should Customers purchase or use Diodes Incorporated products for any unintended or unauthorized application, Customers shall indemnify and hold Diodes Incorporated and its representatives harmless against all claims, damages, expenses, and attorney fees arising out of, directly or indirectly, any claim of personal injury or death associated with such unintended or unauthorized application.

Products described herein may be covered by one or more United States, international or foreign patents pending. Product names and markings noted herein may also be covered by one or more United States, international or foreign trademarks.

This document is written in English but may be translated into multiple languages for reference. Only the English version of this document is the final and determinative format released by Diodes Incorporated.

LIFE SUPPORT

Diodes Incorporated products are specifically not authorized for use as critical components in life support devices or systems without the express written approval of the Chief Executive Officer of Diodes Incorporated. As used herein:

A. Life support devices or systems are devices or systems which:

1. are intended to implant into the body, or
2. support or sustain life and whose failure to perform when properly used in accordance with instructions for use provided in the labeling can be reasonably expected to result in significant injury to the user.

B. A critical component is any component in a life support device or system whose failure to perform can be reasonably expected to cause the failure of the life support device or to affect its safety or effectiveness.

Customers represent that they have all necessary expertise in the safety and regulatory ramifications of their life support devices or systems, and acknowledge and agree that they are solely responsible for all legal, regulatory and safety-related requirements concerning their products and any use of Diodes Incorporated products in such safety-critical, life support devices or systems, notwithstanding any devices- or systems-related information or support that may be provided by Diodes Incorporated. Further, Customers must fully indemnify Diodes Incorporated and its representatives against any damages arising out of the use of Diodes Incorporated products in such safety-critical, life support devices or systems.

Copyright © 2016, Diodes Incorporated

www.diodes.com