

Automation for a Changing World

High Performance / Standard Compact Drive

MS300 Series



Steven. Shih
Motor Drive Solution BU
Industrial Automation BG



Delta Compact Drive



**Standard Compact Drive
MS300 Series**



**High Performance
Compact Drive
MH300 Series**

**Economic
Compact
ME300 Series**

Power Range (kW)	0.2	0.4	0.75	1.5	2.2	3.7	5.5	7.5	11	15	18.5	22	
Standard Model (0~599 Hz)	115V/1-phase												
	230V/1-phase												
	230V/3-phase												
	460V/3-phase												
High Speed Model (>599 Hz)				230V/1-phase									
				230V/3-phase									
				460V/3-phase									
													0.1~7.5 kW (Under developing, will launch in 2018)



Expand into
new
markets

Increase the
added value
of existing
customers

- **Attack application which VFD-M/VFD-E cannot fulfill:**

1. Control PM motor(PMSVC)
2. High speed application (1,500Hz)
3. Functional Safety (STO)
4. Pulse input (33kHz)
5. Internal PLC (2k steps)
6. Communication card (Modbus, CANOpen, Profibus, DeviceNet, ModbusTCP, Ethernet/IP, EtherCAT*)

- **Provide customer better performance than in VFD-M/VFD-E:**

1. EMC (C2:20m, C3:30m)
2. Low leakage current
3. More compact (reduce 6~40%)
4. USB

*under development

MH300 / MS300 Keypad

5-digits LCD display

Digit shift function key

Digital Dial (Quick setting)

Rotary :
Increase or decrease the value of setting, turn to next parameter

Enter :
Saving current setting value or selection



5-digits LED display

Digit shift / up function key

MODE Press "MODE" more than 2 seconds will start shift function

Normal Press (less than 2s)

Potentiometer



Feature – Flexibility Space Utilization

New Compact Design

Smaller but more powerful!
High space utilizing rate !



Zero-stack installation

High installation flexibility
Ambient Temperature : -20 °C ~ 40 °C



**Saving lots of
installation Space!**

Support various motors

Supports IM& PM motors

SPM motors



IPM motors



IM motors



Fast response to impact loading

Fast speed recovery from receiving impact loading :

- High stability in production
- High quality product

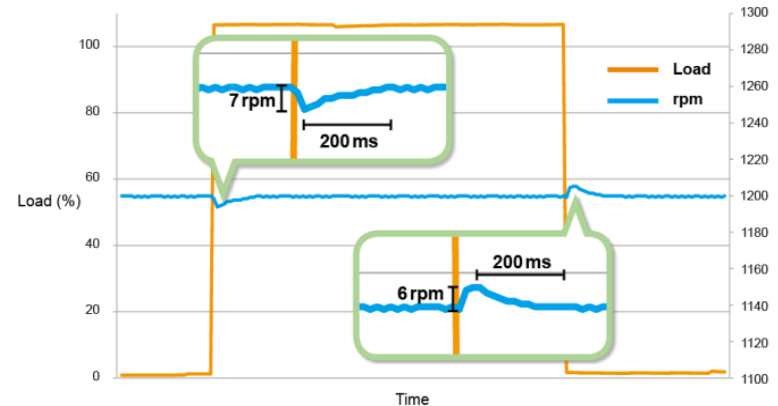

Realize High Starting Torque

Up to 200% rated torque when starting at 0.5 Hz make sure the stability.

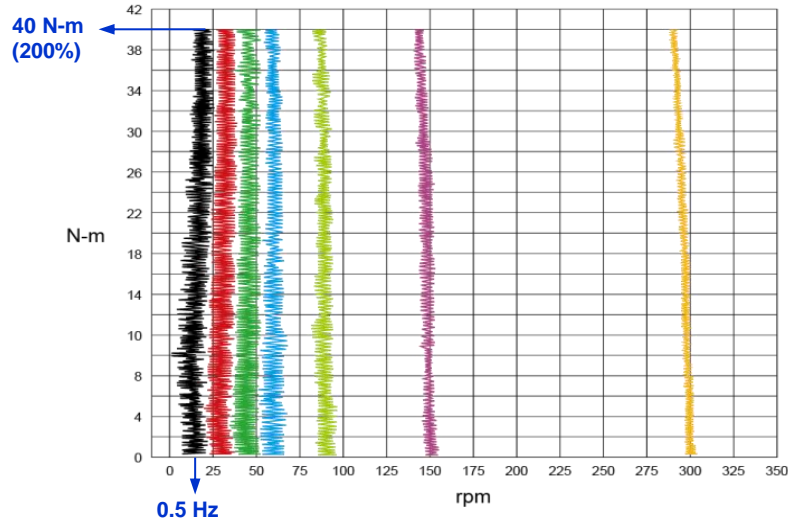

Energy Traction Control

Energy Traction Control mode shorten deceleration time and make the cost of braking resistor down.

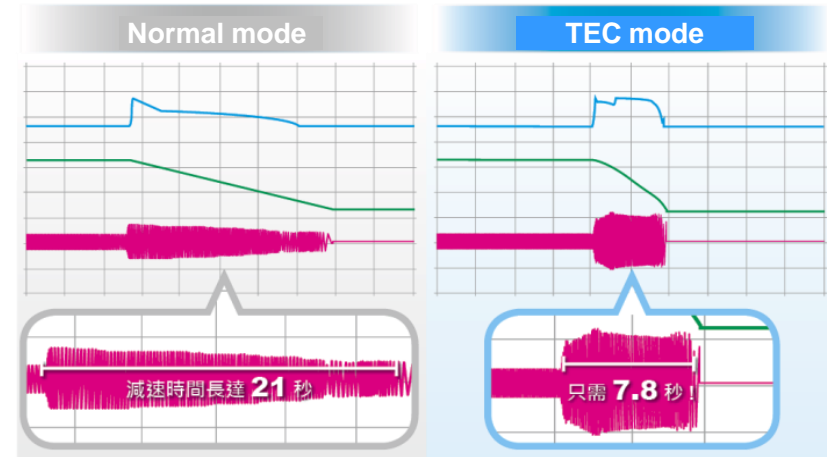

Deceleration time = 21 seconds Deceleration time = 7.8 seconds

- Actual effect depends on the loading conditions

Various Communication Interface

Supports many communication protocols and high flexibility to many applications.

Protocol	MH300	MS300
MODBUS	Built-in	Built-in
CANopen	Built-in	Option
PROFIBUS DP	Option	Option
DeviceNet	Option	Option
MODBUS TCP	Option	Option
EtherNet/IP	Option	Option
EtherCAT	Option	*

*under development

DC 24 V External Power

External Power supply is available to use when main power shut down. Ensure the uninterruptible communication and system safety.

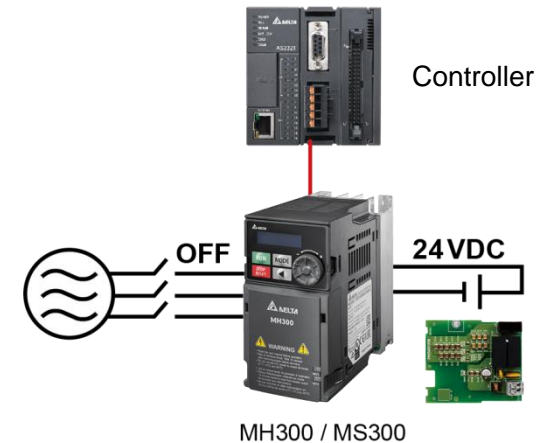

High Frequency Pulse Input

Accept pulse signal from controller or feedback signal from encoder without additional accessories to saving system cost.

- MS300: Signal pulse
- MH300: Dual pulse

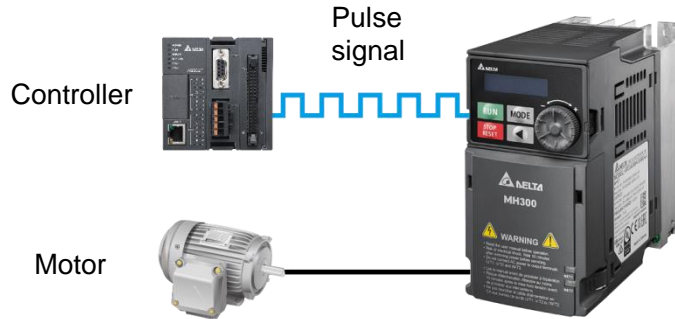

High Speed Application

High speed models are available for high speed processing

- MH300 : 2000 Hz
- MS300 : 1500 Hz

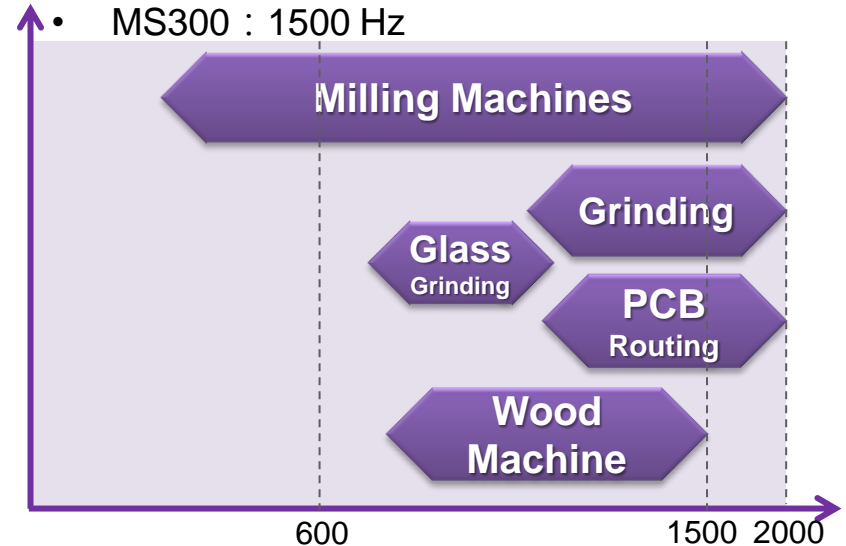

Multi-Motors Control

- MH300 : Up to 8 IM motors
- MS300 : Up to 4 IM motors

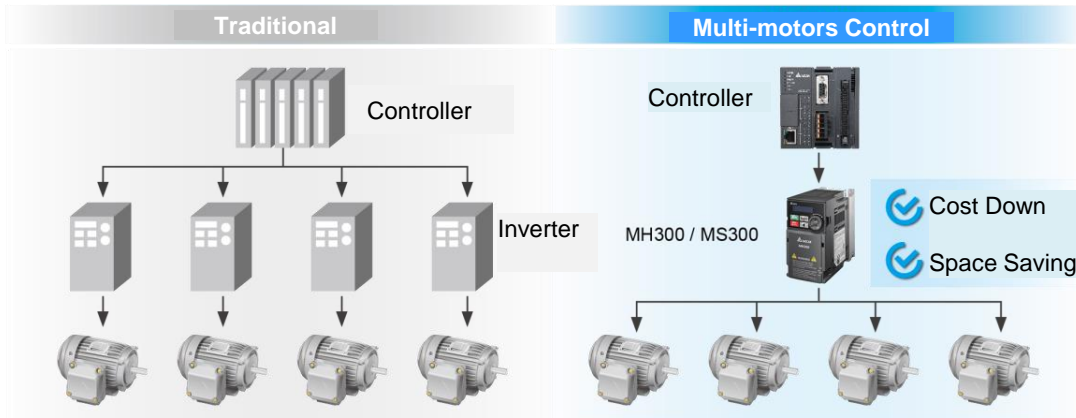

Built-in Delta PLC

Basic Programming is available by built-in PLC for individual requirement and achieve decentralized control

- MH300 : 5 k steps
- MS300 : 2k steps

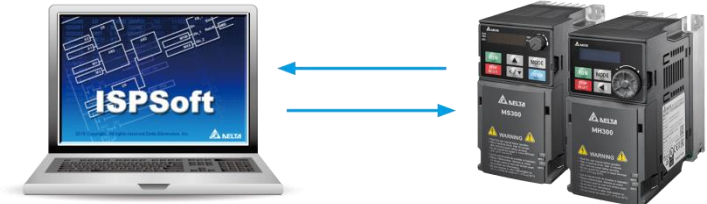

Parameter Group for Application

Too many parameters and too many steps to set in traditional way which takes time and effort...

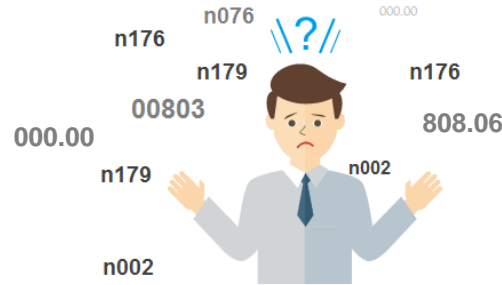

Simplify the setting procedure by viewing and setting the parameter for selected application directly.

- 01 : User Defined
- 02 : Compressor
- 03 : Fan
- 04 : Pump
- 05 : Conveyor
- 06 : Machine tool
- 07 : Packaging



Built-in USB port

Fast and convenient tuning, monitoring and operating.

- No need to use USB / RS-485 converter
- Parameter edit& copy, software update could be done even main power is off.

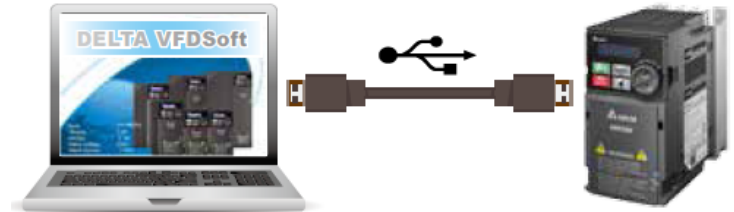

Digital dial and Keypad Outer Extension

Keypad outer extension in MH300/MS300 supports operating away from the drives or control panel.



No Driver for Screw Installation

Spring type terminal makes fast wiring.

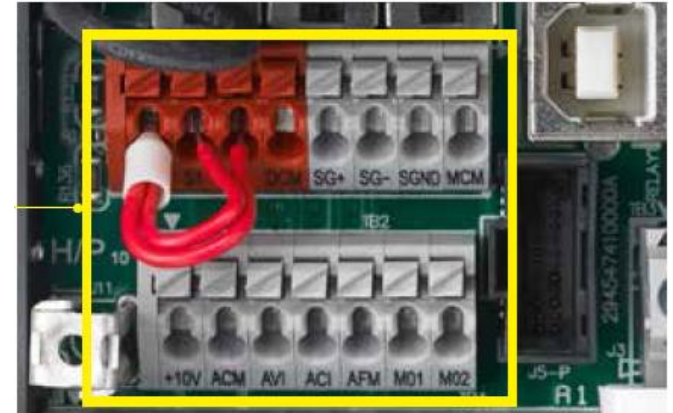

Features – High Reliability

Dirt-proof – PCB coating

100% PCB coating
 Meet IEC 60721-3-3 class 3C2
 Resistant to moisture, corrosion and dust.

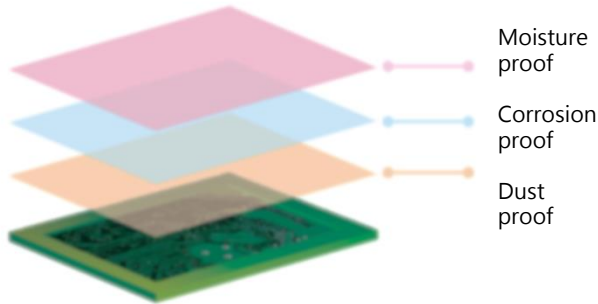

IP 40

Coating Fan+ Sealed ventilation
 Protected against access to dust or other particles.
 Suitable for harsh environment



Built-in EMC filter

Built-in Class A (C2) EMC filter to save space, installation time and system cost.

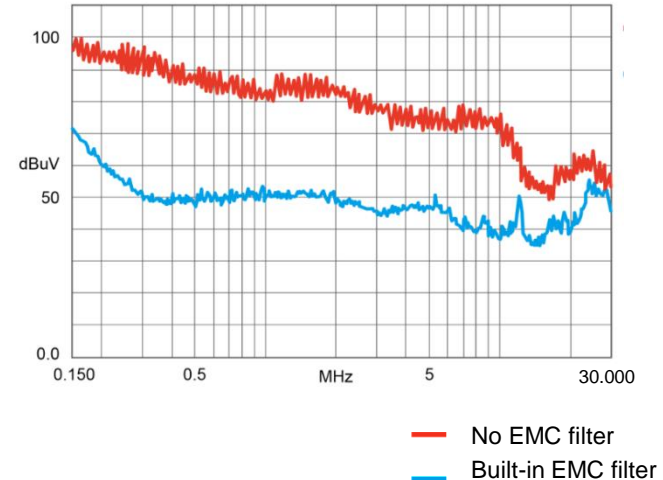

Built-in STO (Safe Torque Off)

Qualified for safety standards:

➤ EN ISO 13849-1 Cat3 / PLd

➤ EN 61508 SIL2

➤ EN 60204-1 Category 0

➤ EN 62061 SIL CL 2

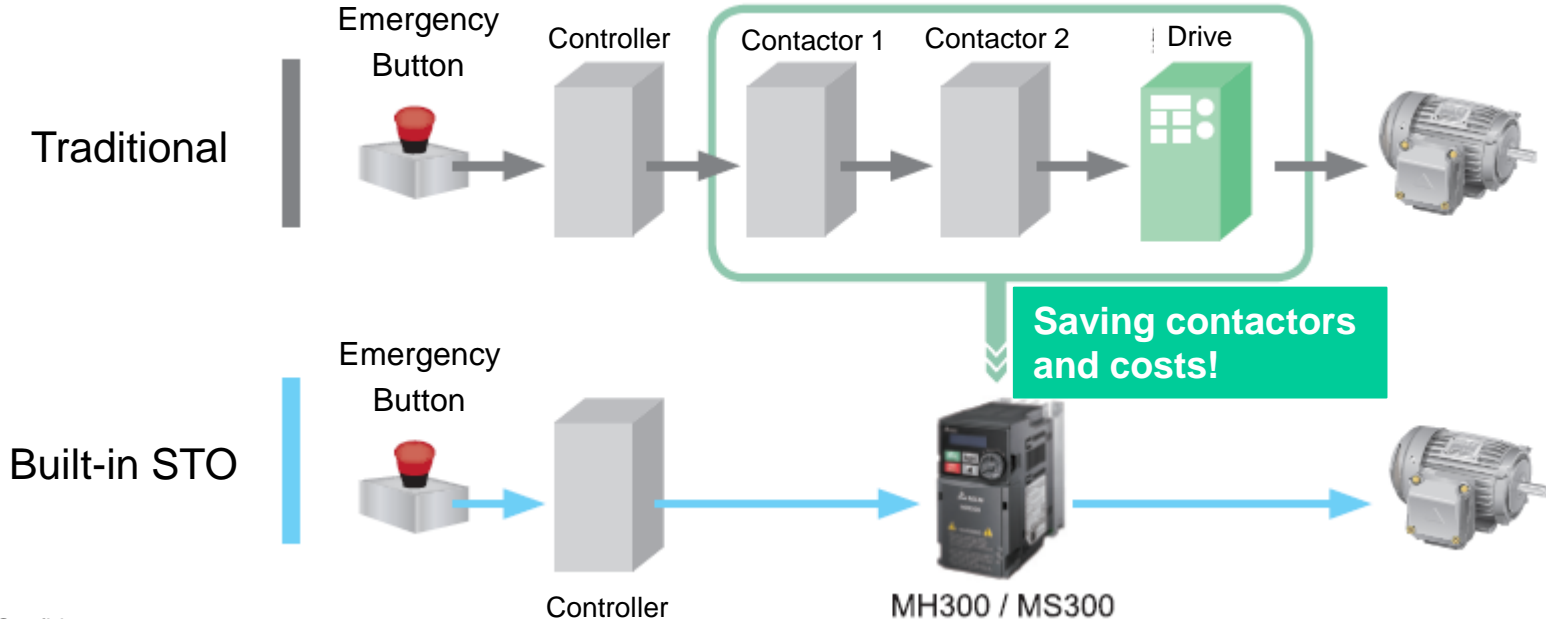



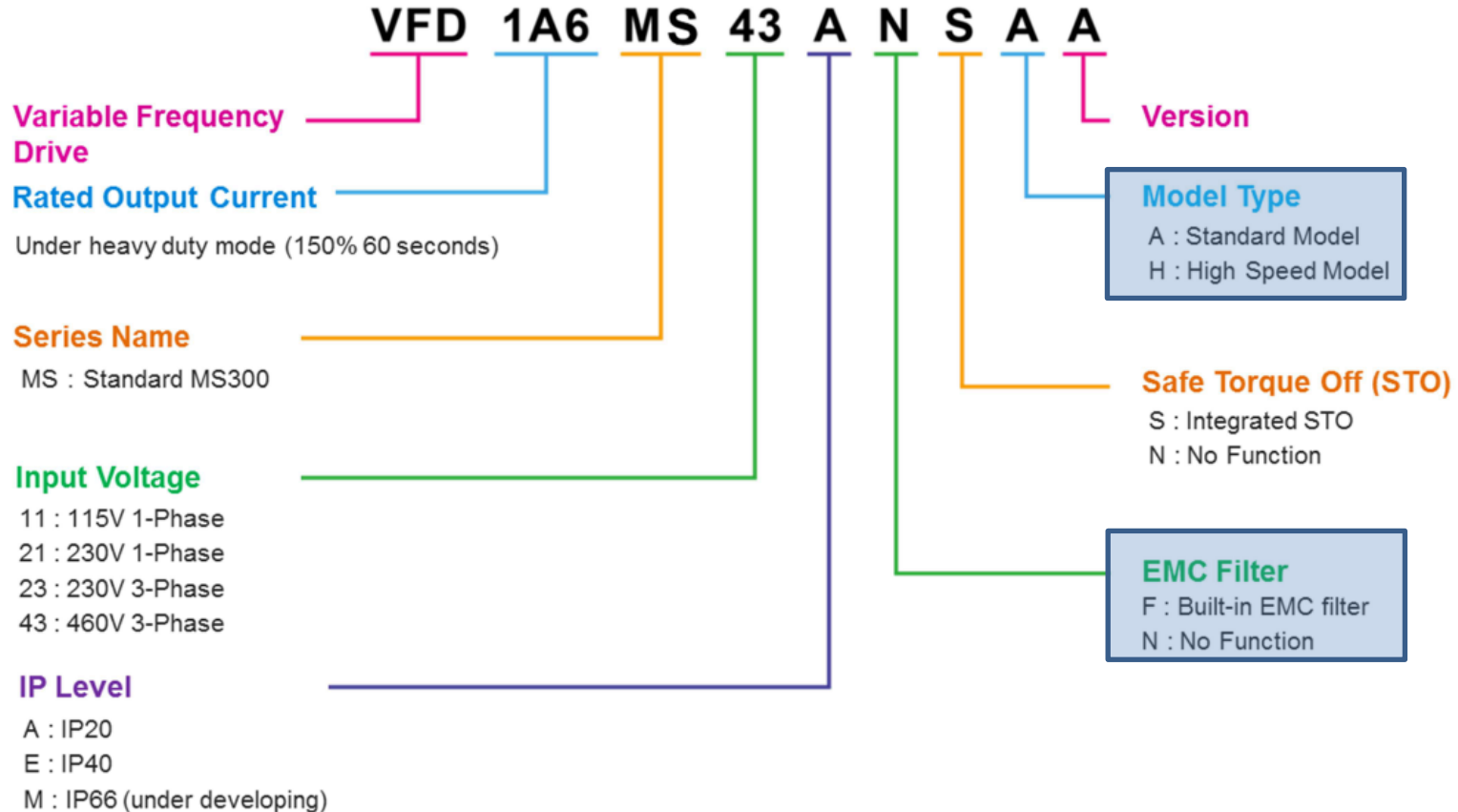

MH300 / MS300 Model Name



Machine tool 	Textiles 	Wood 	Packing 
Food and Beverag 	Compressor 	Pump 	Fan 
Electronics 			

MS300 v.s. VFD-E / VFD-M

VFD Series	MS300	E	M
			
Motor	IM、SPM、IPM	IM	IM
Control	V/F、SVC	V/F, SVC	V/F, SVC
PG card	x	AB	x
Option card	Communication	I/O, Relay, Comm.	x
Keypad	LED 5-digits (removable)	LED 4-digits (removable)	LED 4-digits (removable)
Pulse input	1 (33KHz)	x	x
Pulse output (DFM)	1 (33KHz)	x	x
Safe Torque Off (STO)	EN ISO 13849-1 Cat3 / PLd EN 61508 SIL2 EN 60204-1 Category 0 EN 62061 SIL CL 2	x	x
Built-in EMC filter	C2	C3	x
Built-in USB port	Yes	x	x
Integrated PLC	Yes (2000 steps)	Yes (500 steps)	x

MS300 User Interface

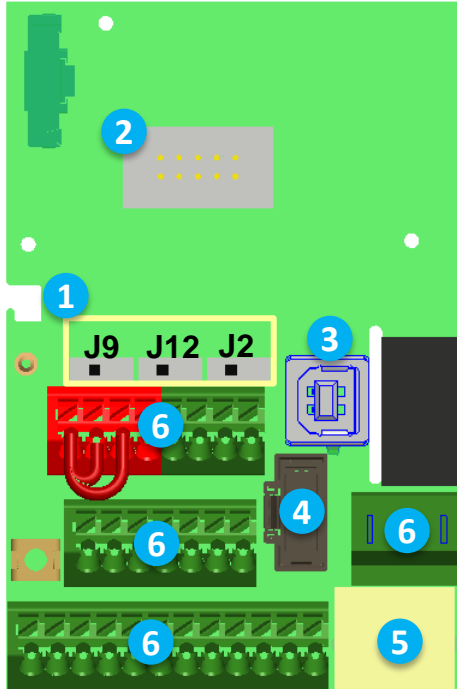

No.	Interface	Function
1	Switch J9	Analog input (ACI) switching 0~10V / (0)4~20mA
	Switch J12	Analog output 0~10V / (0)4~20mA switching
	Switch J2	PNP/NPN switching
2	Keypad connector	Keypad connector
3	USB port	Program update 、 Parameter copy 、 Monitor(Trace)
4	Slot 1	Option card connection for (Comm. Card or DC 24V card)
5	Comm. port	RS 485
6	I/O	Control terminals





Size Comparison

460V/kW	MS300			VFD - E			MS300 vs E	VFD - M			MS300 vs M
	W	H	D	W	H	D		W	H	D	
0.4	68	128	129	72	142	152	-11%	-	-	-	-
0.75	68	128	143	72	142	152	-11%	100	151	116.5	-29%
1.5	72	142	143	72	142	152	5%	100	151	116.5	-17%
2.2	87	157	152	100	174	152	-8%	100	151	116.5	18%
3.7	87	157	152	100	174	152	-8%	125	220	166.3	-55%
5.5	109	207	154	130	260	169.2	-26%	125	220	166.3	-24%
7.5	109	207	154	130	260	169.2	-26%	125	220	166.3	-24%
11	130	250	185	130	260	169.2	24%	-	-	-	-
15	130	250	185	200	310	190	-40%	-	-	-	-
18.5	175	300	192	200	310	190	9%	-	-	-	-
22	175	300	192	200	310	190	9%	-	-	-	-

460V/kW	MH300			VFD - B			MH300 vs B	C200			MH300 vs C200
	W	H	D	W	H	D		W	H	D	
0.4	68	128	129	-	-	-	-	-	-	-	-
0.75	68	128	135	118	185	145	-63%	110	180	160	-63%
1.5	72	142	143	118	185	160	-58%	110	180	160	-54%
2.2	87	157	152	118	185	145	-34%	110	180	151	-31%
3.7	87	157	152	150	260	160	-67%	110	180	151	-31%
5.5	109	207	154	200	323	183.2	-71%	130	250	179	-40%
7.5	109	207	154	200	323	183.2	-71%	130	250	179	-40%
11	130	250	178	200	323	183.2	-51%	-	-	-	-
15	130	250	178	250	430.8	205.4	-74%	-	-	-	-
18.5	185	275	192	250	430.8	205.4	-56%	-	-	-	-
22	185	275	192	250	430.8	205.4	-56%	-	-	-	-

MH300 / MS300 Option Cards

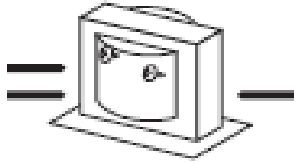
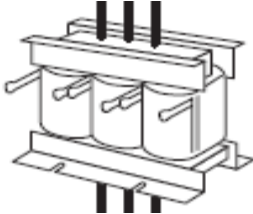
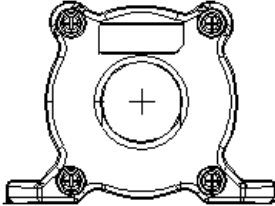
Option cards	Model	Function	Available Series	
			MH300	MS300
Communication card	CMM-DN01	DeviceNet	√	√
	CMM-EIP01	EtherNet/IP	√	√
	CMM-PD01	Profibus DP	√	√
	CMM-MOD01	Modbus TCP	√	√
	CMM-EC01	EtherCAT	√	-
	CMM-COP01	CANopen	Built-in	√
External DC power supply	EMM-BPS01	DC 24V power supply card	√	√
I/O expansion card	EMM-D33A	Digital Card – 3in 3out	√	-
	EMM-A22A	Analog Card – 2in 2out	√	-
	EMM-R2CA	Relay Card	√	-
	EMM-R3AA	Relay Card	√	-
PG card	EMM-PG01L	ABZ (Line driver)	√	-
	EMM-PG01O	ABZ (Open Collector)	√	-
	EMM-PG01R	Resolver	√	-

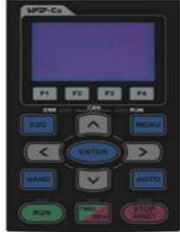
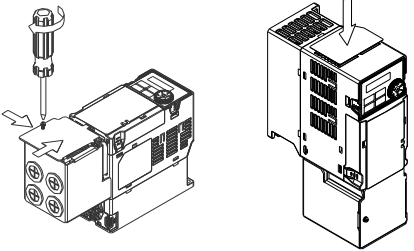
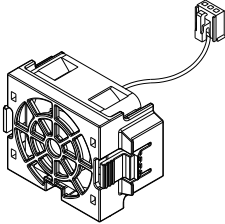
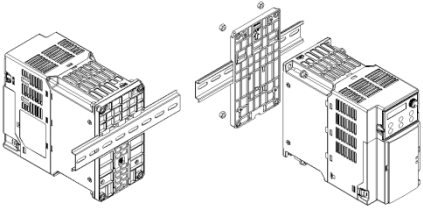
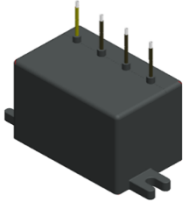
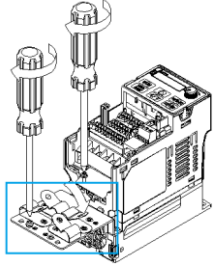
Brake Resistor	DC Reactor	AC Reactor	Zero Phase Reactor	EMC Filter	KPC-CC01
<p>125% braking torque / 10%ED</p> 					
Conduit Box		Fan Kit	DIN Rail		Capacitor-type Noise Filter
					
					

MS300 Mounting Adapter Plate



Use

The wiring can fit to VFD-M · VFD-E

[PS]: Currently available in less than 5HP (Frame C) models.

