

NOTES:

1. MATERIALS: HOUSING--LIQUID CRYSTAL POLYMER (LCP), GLASS FILLED, UL94V-0, COLOR: BLACK, TERMINAL: PHOSPHOR BRONZE.
2. FINISH: 0.75 MICROMETERS MINIMUM SELECTIVE GOLD (Au) IN MATING AREA; 2.50 MICROMETERS MINIMUM SELECTIVE TIN (Sn) IN TAIL AREA; NICKEL (Ni) UNDERPLATE OVERALL.
3. THIS PART CONFORMS TO MOLEX PRODUCT SPECIFICATION PS-73670-9999.
4. FOR MIXED CONTACT MATING LENGTHS, CONSULT FACTORY FOR AVAILABILITY.
5. PACKAGE PER PK-70873-0818.
6. PARTS MARKED WITH PART NUMBER AND DATE CODE, ON EITHER SIDE, APPROXIMATELY WHERE SHOWN.

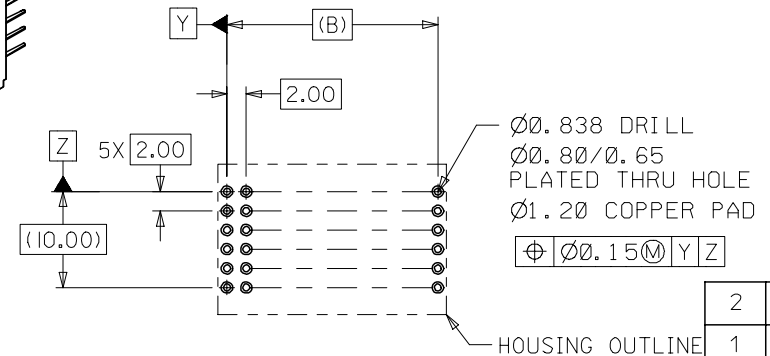
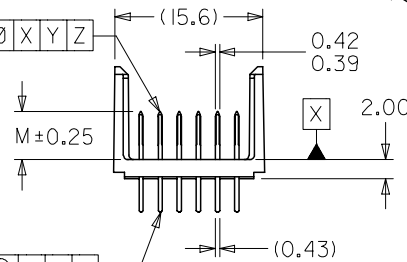
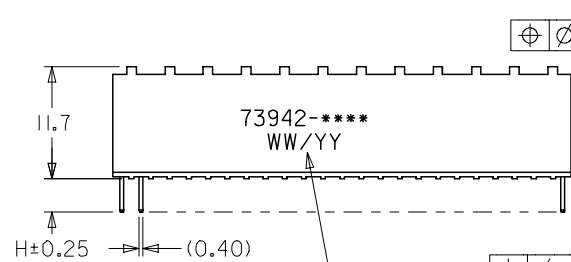
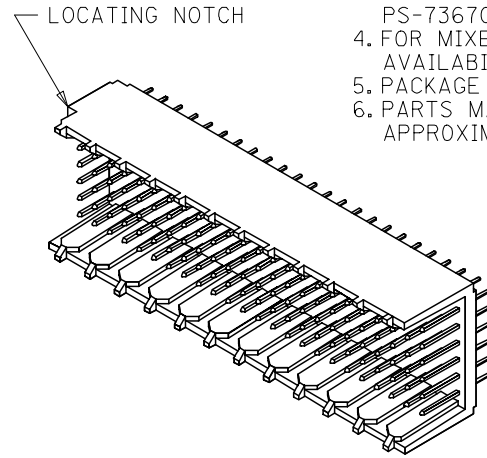
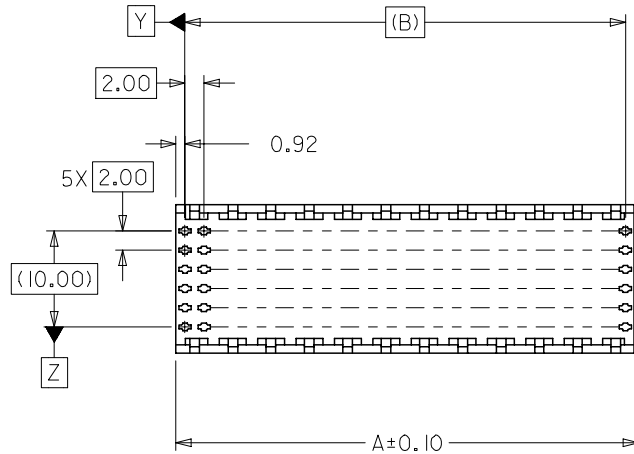

PCB LAYOUT: COMPONENT SIDE
RECOMMENDED PCB THICKNESS: 2.50 MIN.

2	A
1	G
SHT	REV

MODIFY FINISH NOTE	DESCRIPTION
EC NO: UCP2007-2259	
IDRW:MSIBARRA 2007/03/13	
CHKD:BBARKER 2007/03/21	
APPR:SMILLER 2007/03/22	
REV	

QUALITY SYMBOLS	
▽=0	
▽=0	

GENERAL TOLERANCES (UNLESS SPECIFIED)	
	mm
	INCH
4 PLACES	± ---
3 PLACES	± ---
2 PLACES	± 0.05
1 PLACE	± 0.10
ANGULAR ±1/2°	
DRAFT WHERE APPLICABLE MUST REMAIN WITHIN DIMENSIONS	

DIMENSION STYLE	SCALE
MM ONLY	2:1
DESIGN UNITS	
METRIC	
THIRD ANGLE PROJECTION	
DRAWN BY	DATE
JB INGHAM	1998/01/13
CHECKED BY	DATE
SREED	1998/01/13
APPROVED BY	DATE
CBIXLER	1998/01/13
MATERIAL NO.	DOCUMENT NO.
SEE CHART	SD-73942-001



TITLE	
SALES ASSY HDM BACKPLANE OPEN END OPTION SOLDER TAIL VERSION	
MOLEX INCORPORATED	
SHEET NO.	1 OF 2

MATERIAL NUMBER ASSIGNMENT

73942-* * 0 0

NUMBER	CIRCUIT SIZE	DIM "A"	DIM "B"	DIM "H"
0	72	23.84	22.00	2.0
1	144	47.84	46.00	2.0
2	72	23.84	22.00	2.5
3	144	47.84	46.00	2.5
4	72	23.84	22.00	3.0
5	144	47.84	46.00	3.0
6	72	23.84	22.00	3.5
7	144	47.84	46.00	3.5

NUMBER	DIM "M"
0	5.0
1	5.5
2	6.0

SEE SHEET 1 EC No. U8 1577 DRWN:JBINGHAM 98/0203 CHK: SREED 98/0203 APPR:CBIXLER 98/0203	MAJOR  = 0	CRITICAL  = 0	DESCRIPTION REV	QUALITY SYMBOLS	GENERAL TOLERANCES: (UNLESS SPECIFIED)	SCALE ---:--	DESIGN UNITS <input checked="" type="checkbox"/> mm <input type="checkbox"/> INCH	DIMENSIONS: <input type="checkbox"/> mm INCH <input type="checkbox"/> INCH mm <input checked="" type="checkbox"/> mm ONLY	SHT REV	
	DRAFT WHERE APPLICABLE MUST REMAIN WITHIN DIMENSIONS				4 PLACES ±0. _. ±. 3 PLACES ±0. _. ±. 2 PLACES ±0.N/A ±. 1 PLACE ±0.N±A ±.	DRAWN BY & DATE JBINGHAM 98/01/13	THIRD ANGLE PROJECTION			TITLE: SALES ASSY, HDM BACKPLANE OPEN END OPTION SOLDER TAIL VERSION
	A					APPROVED BY & DATE CBIXLER 98/01/13	MOLEX INCORPORATED			REVISION ON CAD ONLY
						ANGLAR: ± °	CAD FILENAME S73942X2.DGN	MATERIAL NO. SEE CHART	DRAWING NO. SD-73942-001	SHEET NO. 2