



MIC5337

1.2mm x 1.6mm 300mA Low I_Q LDO
Ultra Low Dropout with Auto Discharge

General Description

The MIC5337 is a low quiescent current, low dropout regulator with an internal auto discharge feature designed for optimal performance in a small space. The MIC5337 is capable of sourcing 300mA of output current while only consuming 24 μ A of operating current. When the MIC5337 is disabled an internal resistive load is automatically applied to the output to discharge the output capacitor. This high performance LDO offers fast transient response as well as maintaining a high PSRR.

The MIC5337 is an ideal solution for battery operated applications due to ultra low operating current and extremely low dropout voltage of 180mV at 300mA. Equipped with a TTL logic compatible enable pin, the MIC5337 can be put into a zero-off-mode current state, drawing virtually no current when disabled.

Board space and component cost is minimized because the MIC5337 operates with very small 1 μ F ceramic capacitors, provides fixed output voltages, and is available in the tiny 1.2mm x 1.6mm Thin MLF package.

Data sheets and support documentation can be found on Micrel's web site at www.micrel.com.

Features

- 300mA output current
- Low I_Q: only 24 μ A operating current
- Low dropout voltage of 180mV @ 300mA
- Active discharge when enable pin is low
- Input voltage range: 2.3V to 5.5V
- Fixed output voltages
- Stable with 1 μ F ceramic capacitors
- Thermal shutdown and current limit protection
- Tiny 4-pin 1.2mm x 1.6mm Thin MLF[®] package

Applications

- Mobile phones
- GPS and navigation devices
- Portable media players
- Digital still and video cameras
- PDAs
- Portable electronics

Typical Application

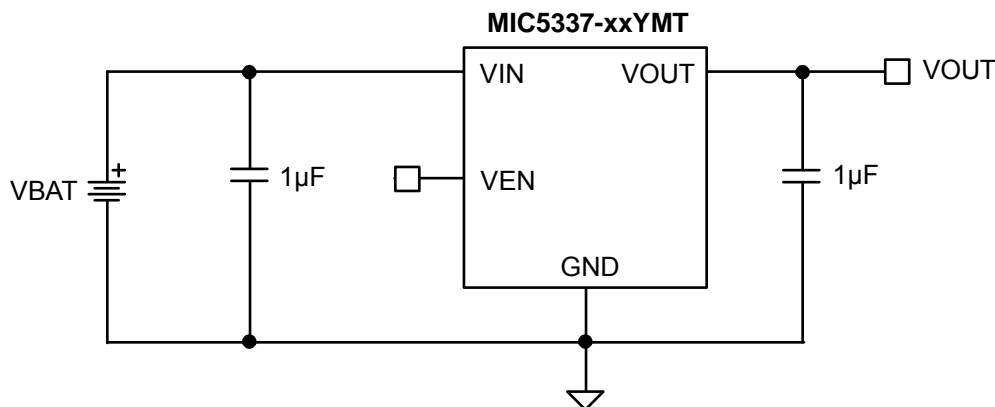

MLF and *MicroLeadFrame* are registered trademarks of Amkor Technology, Inc.

Micrel Inc. • 2180 Fortune Drive • San Jose, CA 95131 • USA • tel +1 (408) 944-0800 • fax + 1 (408) 474-1000 • <http://www.micrel.com>

Ordering Information

Part Number	Marking ⁽¹⁾	Voltage ⁽²⁾	Temperature Range	Package ⁽³⁾
MIC5337-2.8YMT	281	2.8V	-40° to +125°C	4-Pin 1.2mm x 1.6mm Thin MLF [®]
MIC5337-1.8YMT	181	1.8V	-40° to +125°C	4-Pin 1.2mm x 1.6mm Thin MLF [®]

Note:

1. Pin 1 identifier= "▲".
2. For other voltage options contact Micrel Marketing.
3. MLF is a GREEN RoHS compliant package. Lead finish is NiPdAu, Mold compound is Halogen Free.

Pin Configuration

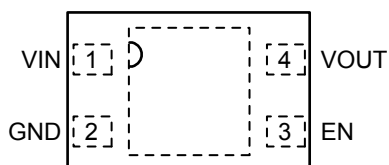

4-Pin 1.2mm x 1.6mm Thin MLF[®] (MT)

Pin Description

Pin Number	Pin Name	Pin Function
1	VIN	Supply Input.
2	GND	Ground.
3	EN	Enable Input: Active High Input. Logic High = On; Logic Low = Off. Do not leave floating.
4	VOUT	Output Voltage.
HS Pad	EPAD	Exposed heatsink pad connected to ground internally.

Absolute Maximum Ratings⁽¹⁾

Supply Voltage (V_{IN})	-0.3V to +6V
Enable Voltage (V_{EN})	-0.3V to V_{IN}
Power Dissipation (P_D)	Internally Limited ⁽³⁾
Lead Temperature (soldering, 5 μ sec.)	260°C
Junction Temperature (T_J)	-40°C to +125°C
Storage Temperature (T_S)	-65°C to +150°C
ESD Rating ⁽⁴⁾	2kV

Operating Ratings⁽²⁾

Supply Voltage (V_{IN})	+2.3V to 5.5V
Enable Voltage (V_{EN})	0V to V_{IN}
Junction Temperature (T_J)	-40°C to +125°C
Junction Thermal Resistance	
1.2mm x 1.6mm Thin MLF-4 (θ_{JA})	173°C/W

Electrical Characteristics⁽⁵⁾

$V_{IN} = V_{EN} = V_{OUT} + 1V$; $C_{OUT} = 1\mu F$; $I_{OUT} = 100\mu A$; $T_J = 25^\circ C$, **bold** values indicate $-40^\circ C$ to $+125^\circ C$, unless noted.

Parameter	Condition	Min	Typ	Max	Units
Output Voltage Accuracy	Variation from nominal V_{OUT}	-1.5		+1.5	%
	Variation from nominal V_{OUT}	-2.0		+2.0	%
Line Regulation	$V_{IN} = V_{OUT} + 1V$ to 5.5V, $I_{OUT} = 100\mu A$		0.01	0.3	%/V
	$V_{IN} = V_{OUT} + 1V$ to 5.5V, $I_{OUT} = 100\mu A$			0.5	%/V
Load Regulation ⁽⁶⁾	$I_{OUT} = 100\mu A$ to 300mA		0.05	1	%
Dropout Voltage ⁽⁷⁾	$I_{OUT} = 50mA$		30		mV
	$I_{OUT} = 100mA$		60		mV
	$I_{OUT} = 150mA$		90	150	mV
	$I_{OUT} = 300mA$		180	300	mV
Ground Pin Current ⁽⁸⁾	$I_{OUT} = 100\mu A$ to 300mA		24	35	μA
Ground Pin Current in Shutdown	$V_{EN} = 0V$		0.01	1	μA
Ripple Rejection	$f = 1kHz$; $C_{OUT} = 1\mu F$; $I_{OUT} = 300mA$		65		dB
	$f = 20kHz$; $C_{OUT} = 1\mu F$; $I_{OUT} = 300mA$		50		dB
Current Limit	$V_{OUT} = 0V$	400	600	950	mA
Output Voltage Noise	$C_{OUT} = 1\mu F$, 10Hz to 100kHz		90		μV_{RMS}
Auto-Discharge NFET Resistance	$V_{EN}=0V$, $V_{IN}=3.6V$		280	400	Ω
Enable Voltage					
Enable Voltage	Logic Low			0.2	V
	Logic High	1.2			V
Enable Current	$V_{IL} \leq 0.2V$		0.01	1	μA
	$V_{IH} \geq 1.2V$		0.01	1	μA
Turn-on Time	$C_{OUT} = 1\mu F$; $I_{OUT} = 300mA$		150	500	μs

Notes:

- Exceeding the absolute maximum rating may damage the device.
- The device is not guaranteed to function outside its operating rating.
- The maximum allowable power dissipation of any T_A (ambient temperature) is $P_{D(max)} = (T_{J(max)} - T_A) / \theta_{JA}$. Exceeding the maximum allowable power dissipation will result in excessive die temperature and the regulator will go into thermal shutdown.
- Devices are ESD sensitive. Handling precautions recommended. Human body model, 1.5k Ω in series with 100pF.
- Specification for packaged product only.
- Regulation is measured at constant junction temperature using low duty cycle pulse testing; changes in output voltage due to heating effects are covered by the thermal regulation specification.
- Dropout voltage is defined as the input-to-output differential at which the output voltage drops 2% below its nominal V_{OUT} .
- Ground pin current is the regulator quiescent current. The total current drawn from the supply is the sum of the load current plus the ground pin current.

Typical Characteristics

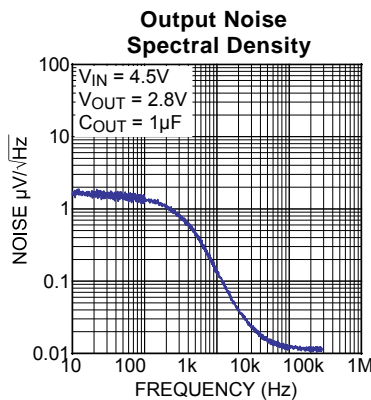
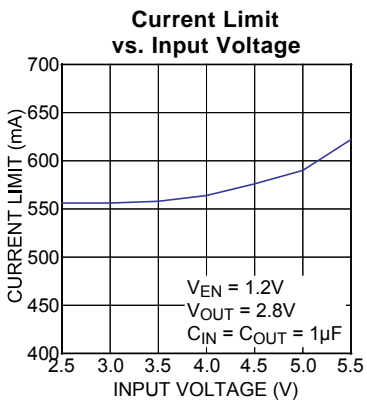
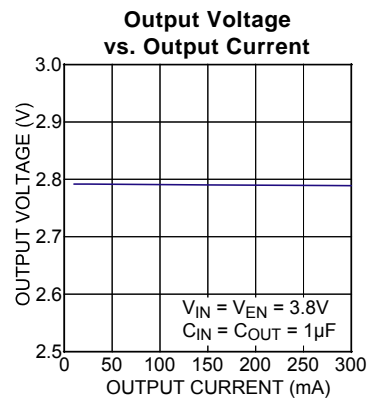
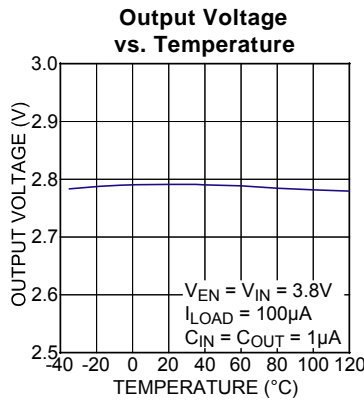
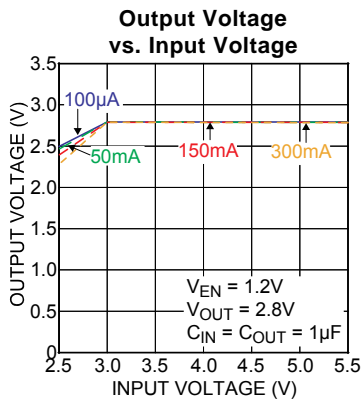
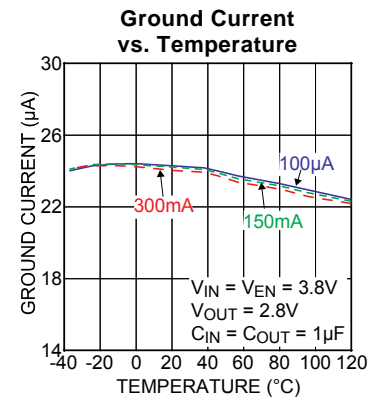
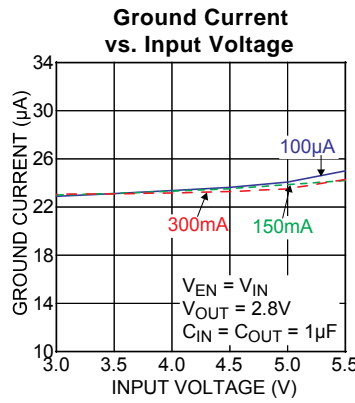
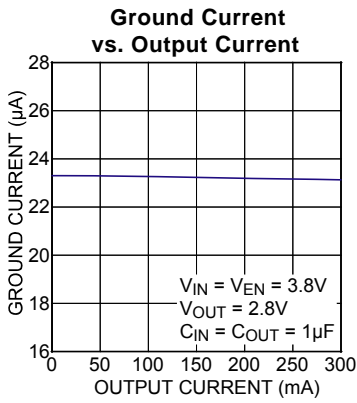
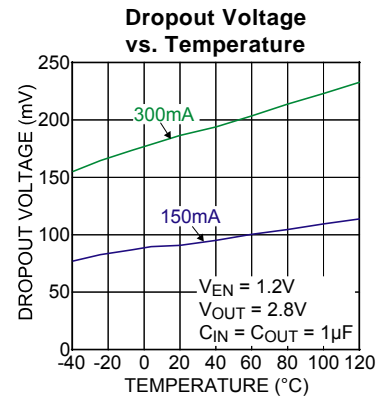
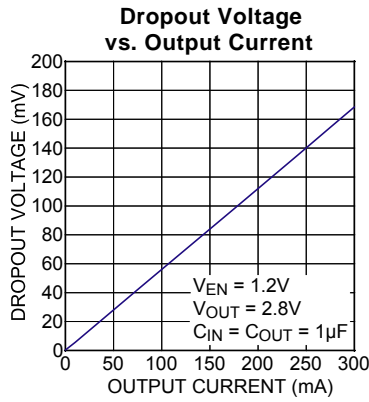
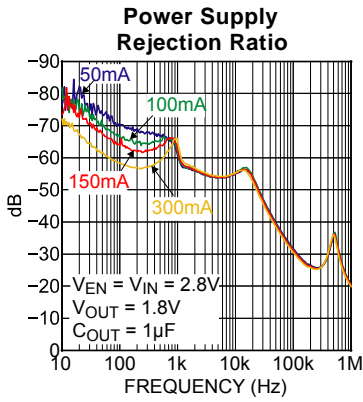

Functional Characteristics

Turn-On Time

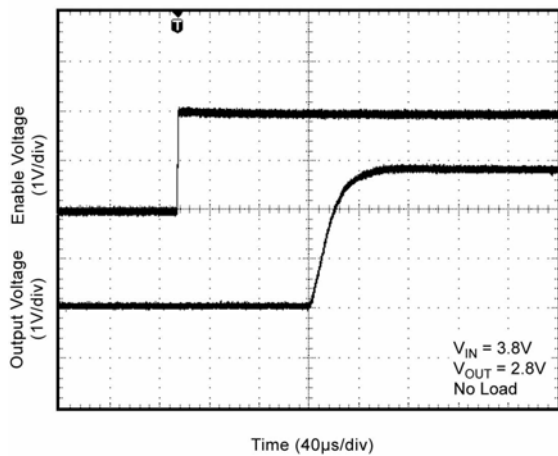

Turn-Off Time

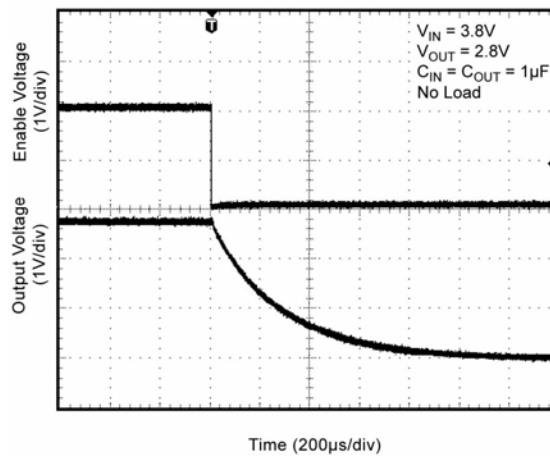

Turn-Off Time

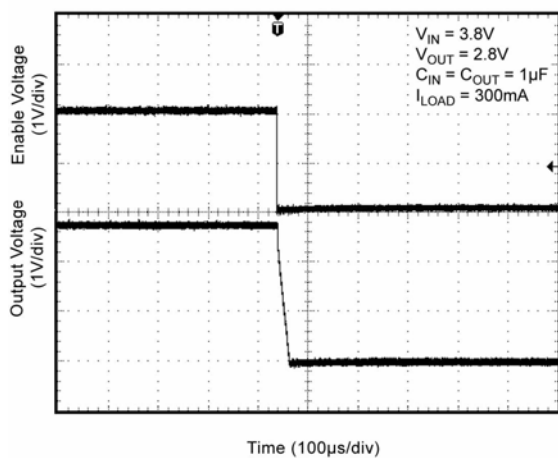

Load Transient

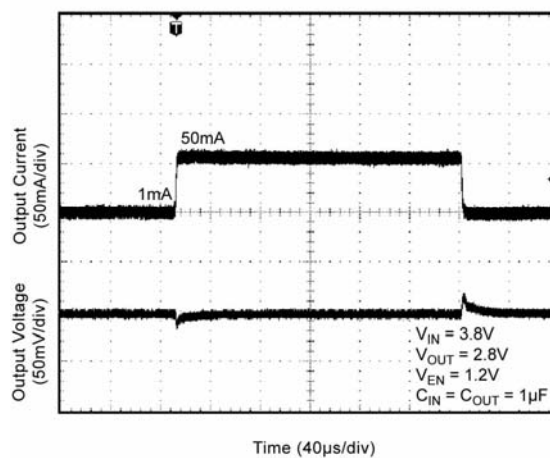

Load Transient

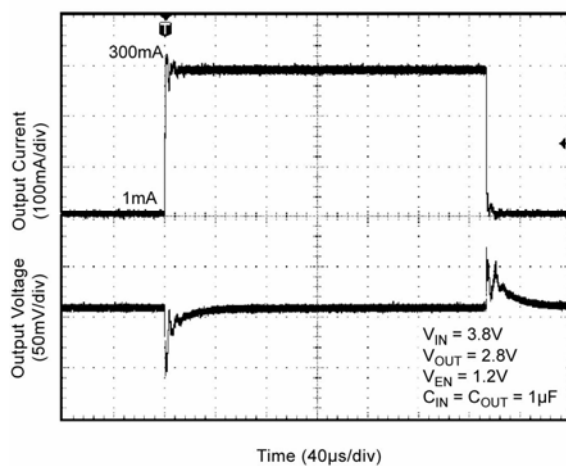

Functional Characteristics (continued)

Load Transient

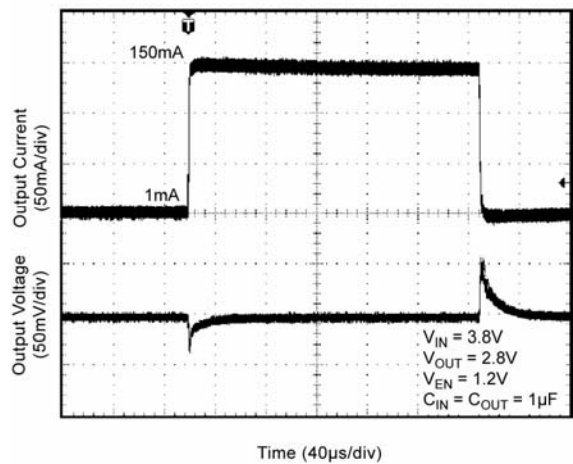

Line Transient

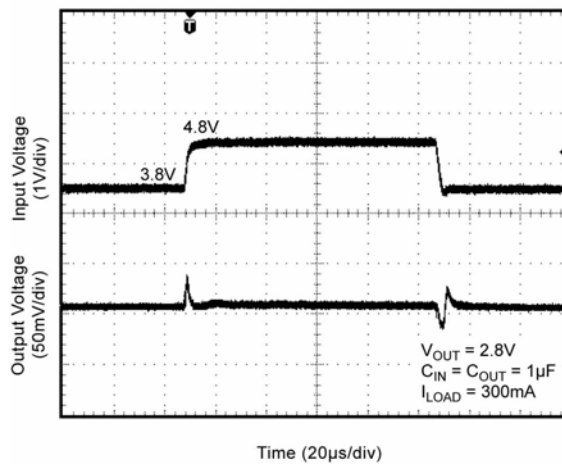

Functional Diagram

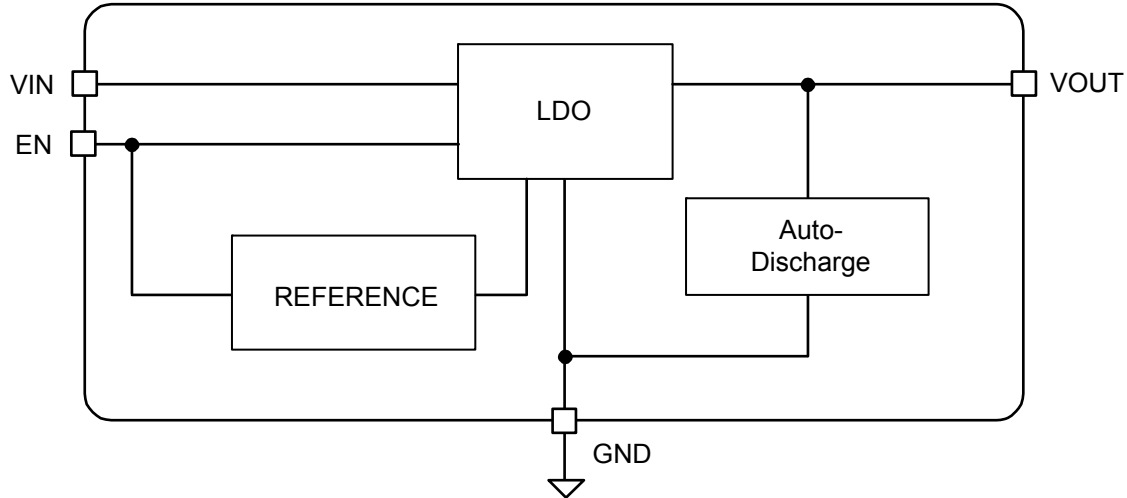

Applications Information

The MIC5337 is a low quiescent current, low dropout regulator designed for optimal performance in a small space. The MIC5337 regulator is fully protected from damage due to fault conditions, offering linear current limiting and thermal shutdown.

Input Supply Voltage

V_{IN} provides the supply to power the LDO. The minimum input voltage is 2.3V allowing conversion from typical lithium ion batteries and low voltage supplies.

Input Capacitor

The MIC5337 is a high performance, high bandwidth device; therefore it requires a well-bypassed input supply for optimal performance. A $1\mu\text{F}$ capacitor is required from the input to ground to provide stability. Low ESR ceramic capacitors provide optimal performance with minimum space required. Additional high frequency capacitors, such as small value NPO dielectric type capacitors, help filter out high frequency noise and are good practice in any RF circuit.

Output Capacitor

The MIC5337 requires an output capacitor of $1\mu\text{F}$ or greater to maintain stability. The design is optimized for use with low ESR ceramic chip capacitors. High ESR capacitors may cause high frequency oscillation. The output capacitor can be increased, but performance has been optimized for a $1\mu\text{F}$ ceramic output capacitor. X7R/X5R dielectric type ceramic capacitors are

recommended because of their temperature performance. X7R type capacitors change capacitance by 15% over their operating temperature range. Z5U and Y5V dielectric capacitors change value by as much as 50% and 60% respectively over their operating temperature ranges. To use a ceramic chip capacitor with Y5V dielectric the value must be much higher than an X7R ceramic capacitor to ensure the same minimum capacitance over the equivalent operating temperature range.

Minimum Load Current

The MIC5337 does not require a minimum load to maintain output voltage regulation.

Enable/Shutdown

The MIC5337 comes with an active high enable pin that enables the regulator. Forcing the enable pin low disables the regulator and sends it into a “zero” off mode current state. In this state, current consumed by the regulator goes nearly to zero. When disabled, the MIC5337 switches a 280Ω load on the regulator output to discharge the external capacitor. The active high enable pin uses CMOS technology and cannot be left floating; a floating enable pin may cause an unknown output state.

Thermal Considerations

The MIC5337 is designed to provide 300mA continuous output current from a very small footprint package. Maximum ambient operating temperature can be calculated based on the output current and the voltage

drop across the part. For example: given that the input voltage is 3.6V, the output voltage is 2.8V and the output current is 300mA. The power dissipation of the regulator circuit can be determined using the equation:

$$P_D = (V_{IN} - V_{OUT1}) I_{OUT} + V_{IN} I_{GND}$$

Because this device is CMOS and the ground current is typically $100\mu A$ over the load range, the power dissipation contributed by the ground current is <math>< 1\%</math> and can be ignored for this calculation.

$$P_D = (3.6V - 2.8V) \times 300mA$$

$$P_D = 0.24W$$

To determine the maximum ambient operating temperature use the junction to ambient thermal resistance of the device and the following basic equation:

$$P_{D(max)} = \left(\frac{T_{J(max)} - T_A}{\theta_{JA}} \right)$$

The maximum junction temperature of the die, $T_{J(max)} = 125^\circ C$. The package thermal resistance, $\theta_{JA} = 173^\circ C/W$.

Substituting P_D for $P_{D(max)}$ and solving for the ambient operating temperature will give the maximum operating conditions for the regulator circuit.

The maximum power dissipation must not be exceeded for proper operation.

For example, when operating the MIC5337 at an input voltage of 3.6V and 300mA load with a minimum footprint layout, the maximum ambient operating temperature T_A can be determined as follows:

$$0.24W = (125^\circ C - T_A) / (173^\circ C/W)$$

$$T_A = 83^\circ C$$

Therefore a 2.8V 300mA application can accept an ambient operating temperature of $83.0^\circ C$ in a 1.2mm x 1.6mm Thin MLF[®] package. For a full discussion of heat sinking and thermal effects on voltage regulators, refer to the "Regulator Thermals" section of *Micrel's Designing with Low Dropout Voltage Regulators* handbook. This information can be found on Micrel's website at:

http://www.micrel.com/_PDF/other/LDOBk_ds.pdf

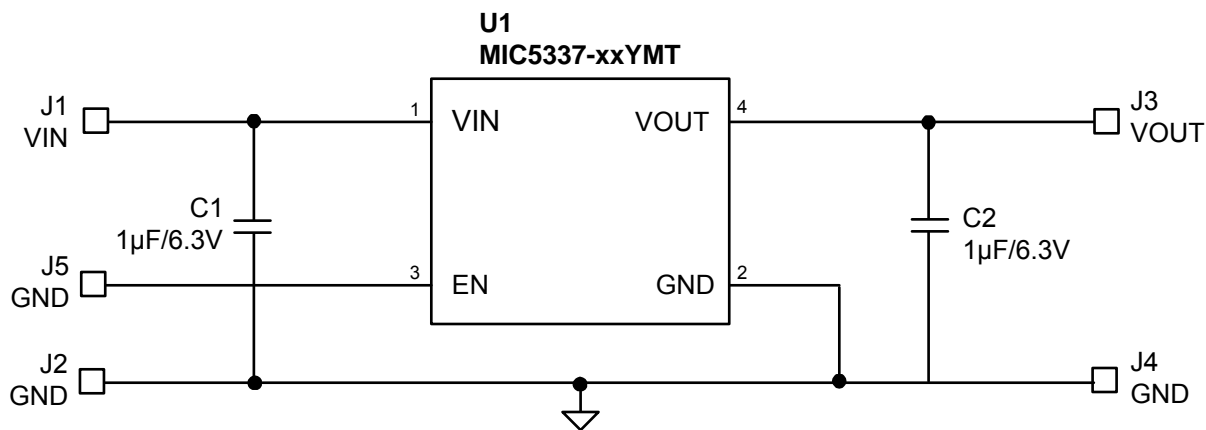

Bill of Materials

Item	Part Number	Manufacturer	Description	Qty.
C1, C2	C1608X5R0J105M	TDK ⁽¹⁾	Capacitor, 1µF, 6.3, X5R, Size 0603	2
U1	MIC5337-xxYMT	Micrel, Inc. ⁽³⁾	300mA low I _Q LDO with Auto Discharge	1

Notes:

1. TDK: www.tdk.com
2. Vishay Dale: Vishay.com
3. Micrel, Inc.: www.micrel.com

PCB Layout Recommendations

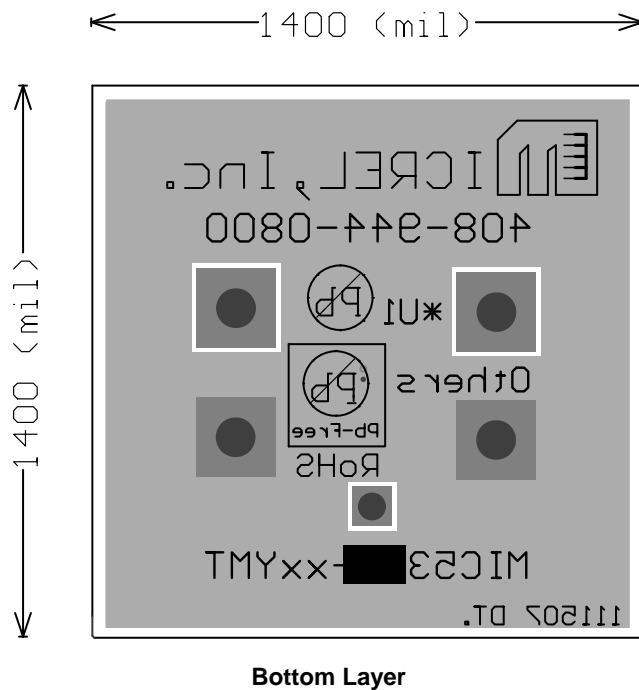
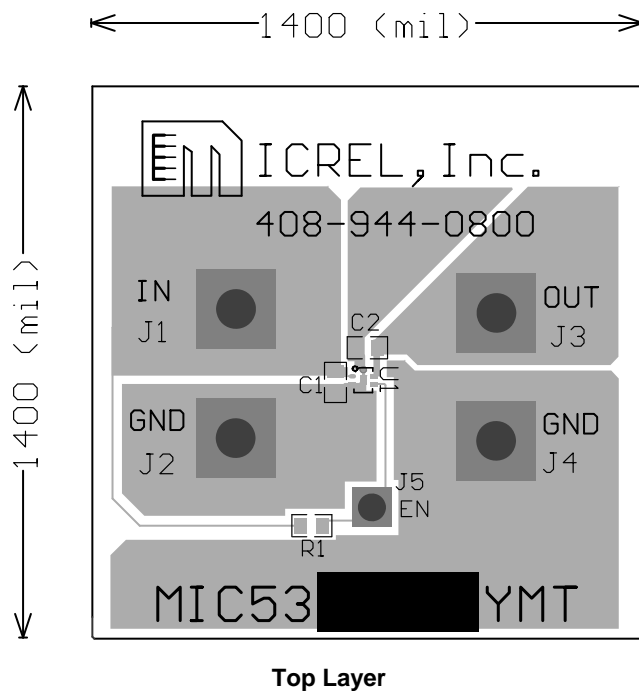

Package Information

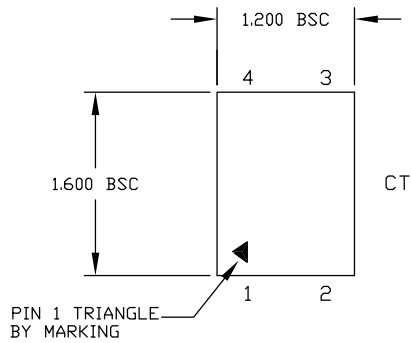

TOP VIEW

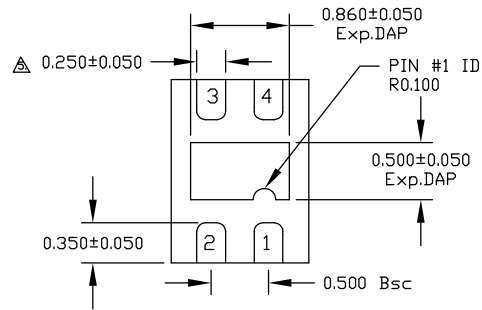

BOTTOM VIEW

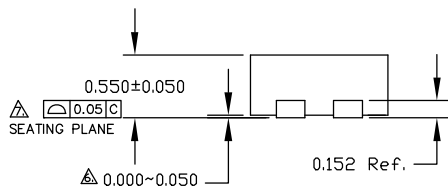

SIDE VIEW

- NOTE:
1. ALL DIMENSIONS ARE IN MILLIMETERS.
 2. MAX. PACKAGE WARPAGE IS 0.05 mm.
 3. MAXIMUM ALLOWABLE BURRS IS 0.076 mm IN ALL DIRECTIONS.
 4. PIN #1 ID ON TOP WILL BE LASER/INK MARKED.
- △ DIMENSION APPLIES TO METALIZED TERMINAL AND IS MEASURED BETWEEN 0.20 AND 0.25 mm FROM TERMINAL TIP.
- △ APPLIED ONLY FOR TERMINALS.
- △ APPLIED FOR EXPOSED PAD AND TERMINALS.

4-Pin 1.2mm x 1.6mm Thin MLF® (MT)

MICREL, INC. 2180 FORTUNE DRIVE SAN JOSE, CA 95131 USA
 TEL +1 (408) 944-0800 FAX +1 (408) 474-1000 WEB <http://www.micrel.com>

The information furnished by Micrel in this data sheet is believed to be accurate and reliable. However, no responsibility is assumed by Micrel for its use. Micrel reserves the right to change circuitry and specifications at any time without notification to the customer.

Micrel Products are not designed or authorized for use as components in life support appliances, devices or systems where malfunction of a product can reasonably be expected to result in personal injury. Life support devices or systems are devices or systems that (a) are intended for surgical implant into the body or (b) support or sustain life, and whose failure to perform can be reasonably expected to result in a significant injury to the user. A Purchaser's use or sale of Micrel Products for use in life support appliances, devices or systems is a Purchaser's own risk and Purchaser agrees to fully indemnify Micrel for any damages resulting from such use or sale.

© 2008 Micrel, Incorporated.