

CONTENT (MLCC)

E STANDARD NUMBER..... 3

STRUCTURE 4

ORDERING CODE 4

 HIGH Q & LOW ESR TYPE (Q SERIES)..... 5

 TEST SPEC. 10

PACKAGE 12

OTHERS 14

E Standard Number

E3	1.0						2.2						4.7											
E6	1.0			1.5			2.2			3.3			4.7			6.8								
E12	1.0	1.2	1.5	1.8	2.2	2.7	3.3	3.9	4.7	5.6	6.8	8.2												
E24	1.0	1.1	1.2	1.3	1.5	1.6	1.8	2.0	2.2	2.4	2.7	3.0	3.3	3.6	3.9	4.3	4.7	5.1	5.6	6.2	6.8	7.5	8.2	9.1

Structure

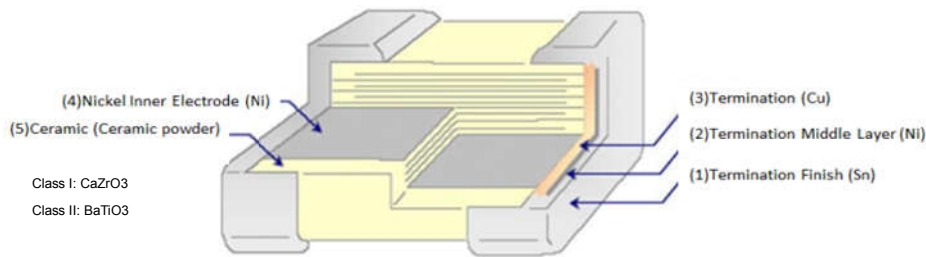

Ordering Code

C 1005 NP0 101 J G T Q

PRODUCT CODE

C = MLCC

SIZE in mm (EIA CODE, in inch)

0402 (01005) 0603 (0201) 1005 (0402) 1608 (0603) 2012 (0805)
3216 (1206) 3225 (1210) 4520 (1808) 4532 (1812)

T. C.

NP0: 0 ± 30ppm/°C -55°C to +125°C
X7R: ±15% -55°C to +125°C X6S: ±22% -55°C to +105°C
X5R: ±15% -55°C to +85°C Y5V: +22%/-82% -30°C to +85°C

CAPACITANCE CODE

Expressed in pico-farads and identified by a three-digit number.
First two digits represent significant figures.
Last digit specifies the number of zeros.
(Use 9 for 1.0 through 9.9pF ; Use 8 for 0.20 through 0.99pF)

Examples:

Code	Cap (pF)
478	0.47
229	2.2
101	100
102	1000

TOLERANCE CODE

A: ± 0.05pF B: ± 0.1pF C: ± 0.25pF D: ± 0.5pF F: ±1% G: ±2%
J: ±5% K: ±10% M: ±20% Z: +80/-20%

VOLTAGE CODE

B: 4V C: 6.3V D: 10V E: 16V F: 25V N: 35V G: 50V H: 100V
J: 200V K: 250V L: 500V M: 630V P: 1KV Q: 2KV R: 3KV S: 4KV

PACKAGING CODE

T: Paper tape reel Ø180mm (7") P: Embossed tape reel Ø180mm (7")
N: Paper tape reel Ø250mm (10") D: Embossed tape reel Ø250mm (10")
A: Paper tape reel Ø330mm (13") E: Embossed tape reel Ø330mm (13")
W: Special Packing

Application Code

S: Standard Q: High Q/Low ESR F: Microwave A: Automotive Infotainment with AEC-Q200

High Q & Low ESR Type (Q Series)

■ Feature

1. Ultra-stable
2. Tight tolerance available
3. Low ESR (Frequency is within 2.4GHz)
4. Good frequency performance
5. No aging of capacitance
6. RoHS compliant
7. Halogen Free

■ Application

1. LC and RC tuned circuit
2. Filtering
3. Timing

■ Standard External Dimensions

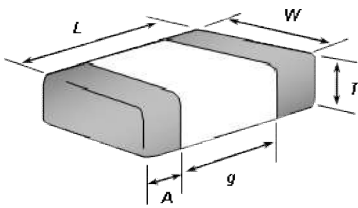

TYPE (EIA Size)	Dimension (mm)				
	L (Length)	W (Width)	T (Max.)	g (Min)	A (Min/Max)
C0603 (0201)	0.6±0.03	0.3±0.03	0.33	0.15	0.10/0.20
C1005 (0402)	1.0 ± 0.05	0.5 ± 0.05	0.55	0.30	0.15 / 0.35
C1608 (0603)	1.6 ± 0.10	0.8 ± 0.10	0.90	0.50	0.25 / 0.65

■ Part Number & Characteristic

● C0603NP0_Q Series (EIA0201)

RV	DARFON P/N	Measuring Condition	Capacitance		Available Tolerance	Thick. (mm)	Tolerance(mm)		ESR(1GHz) mΩ (max.)	Q(1GHz) (min.)	Standard Packing
			Value	Unit			L/W	Thick.			
50V	C0603NP0108CGTQ	1V, 1MHz	0.1	pF	±0.25pF	0.30	±0.03	±0.03	4547	350	Paper, 15Kpcs
	C0603NP0208□GTQ	1V, 1MHz	0.2	pF	±0.25pF, ±0.1pF, ±0.05pF	0.30	±0.03	±0.03	2274	350	
	C0603NP0308□GTQ	1V, 1MHz	0.3	pF	±0.25pF, ±0.1pF, ±0.05pF	0.30	±0.03	±0.03	1516	350	
	C0603NP0408□GTQ	1V, 1MHz	0.4	pF	±0.25pF, ±0.1pF, ±0.05pF	0.30	±0.03	±0.03	1137	350	
	C0603NP0508□GTQ	1V, 1MHz	0.5	pF	±0.25pF, ±0.1pF, ±0.05pF	0.30	±0.03	±0.03	909	350	
	C0603NP0608□GTQ	1V, 1MHz	0.6	pF	±0.25pF, ±0.1pF, ±0.05pF	0.30	±0.03	±0.03	758	350	
	C0603NP0708□GTQ	1V, 1MHz	0.7	pF	±0.25pF, ±0.1pF, ±0.05pF	0.30	±0.03	±0.03	650	350	
	C0603NP0758□GTQ	1V, 1MHz	0.75	pF	±0.25pF, ±0.1pF, ±0.05pF	0.30	±0.03	±0.03	606	350	
	C0603NP0808□GTQ	1V, 1MHz	0.8	pF	±0.25pF, ±0.1pF, ±0.05pF	0.30	±0.03	±0.03	568	350	
	C0603NP0908□GTQ	1V, 1MHz	0.9	pF	±0.25pF, ±0.1pF, ±0.05pF	0.30	±0.03	±0.03	505	350	
	C0603NP0109□GTQ	1V, 1MHz	1.0	pF	±0.25pF, ±0.1pF, ±0.05pF	0.30	±0.03	±0.03	455	350	
	C0603NP0119□GTQ	1V, 1MHz	1.1	pF	±0.25pF, ±0.1pF, ±0.05pF	0.30	±0.03	±0.03	482	300	
	C0603NP0129□GTQ	1V, 1MHz	1.2	pF	±0.25pF, ±0.1pF, ±0.05pF	0.30	±0.03	±0.03	442	300	
	C0603NP0139□GTQ	1V, 1MHz	1.3	pF	±0.25pF, ±0.1pF, ±0.05pF	0.30	±0.03	±0.03	408	300	
	C0603NP0149□GTQ	1V, 1MHz	1.4	pF	±0.25pF, ±0.1pF, ±0.05pF	0.30	±0.03	±0.03	379	300	
	C0603NP0159□GTQ	1V, 1MHz	1.5	pF	±0.25pF, ±0.1pF, ±0.05pF	0.30	±0.03	±0.03	354	300	
	C0603NP0169□GTQ	1V, 1MHz	1.6	pF	±0.25pF, ±0.1pF, ±0.05pF	0.30	±0.03	±0.03	332	300	
	C0603NP0179□GTQ	1V, 1MHz	1.7	pF	±0.25pF, ±0.1pF, ±0.05pF	0.30	±0.03	±0.03	312	300	
	C0603NP0189□GTQ	1V, 1MHz	1.8	pF	±0.25pF, ±0.1pF, ±0.05pF	0.30	±0.03	±0.03	295	300	
	C0603NP0209□GTQ	1V, 1MHz	2.0	pF	±0.25pF, ±0.1pF, ±0.05pF	0.30	±0.03	±0.03	318	250	
	C0603NP0229□GTQ	1V, 1MHz	2.2	pF	±0.25pF, ±0.1pF, ±0.05pF	0.30	±0.03	±0.03	289	250	
	C0603NP0249□GTQ	1V, 1MHz	2.4	pF	±0.25pF, ±0.1pF, ±0.05pF	0.30	±0.03	±0.03	265	250	
	C0603NP0259□GTQ	1V, 1MHz	2.5	pF	±0.25pF, ±0.1pF, ±0.05pF	0.30	±0.03	±0.03	255	250	
	C0603NP0279□GTQ	1V, 1MHz	2.7	pF	±0.25pF, ±0.1pF, ±0.05pF	0.30	±0.03	±0.03	236	250	
C0603NP0309□GTQ	1V, 1MHz	3.0	pF	±0.25pF, ±0.1pF, ±0.05pF	0.30	±0.03	±0.03	265	200		
C0603NP0339□GTQ	1V, 1MHz	3.3	pF	±0.25pF, ±0.1pF, ±0.05pF	0.30	±0.03	±0.03	241	200		
C0603NP0369□GTQ	1V, 1MHz	3.6	pF	±0.25pF, ±0.1pF, ±0.05pF	0.30	±0.03	±0.03	221	200		
C0603NP0399□GTQ	1V, 1MHz	3.9	pF	±0.25pF, ±0.1pF, ±0.05pF	0.30	±0.03	±0.03	204	200		
C0603NP0409CGTQ	1V, 1MHz	4.0	pF	±0.25pF	0.30	±0.03	±0.03	199	200		
C0603NP0439□GTQ	1V, 1MHz	4.3	pF	±0.25pF, ±0.1pF, ±0.05pF	0.30	±0.03	±0.03	185	200		
C0603NP0479□GTQ	1V, 1MHz	4.7	pF	±0.25pF, ±0.1pF, ±0.05pF	0.30	±0.03	±0.03	169	200		

RV	DARFON P/N	Measuring Condition	Capacitance		Available Tolerance	Thick. (mm)	Tolerance(mm)		ESR(1GHz) mΩ (max.)	Q(1GHz) (min.)	Standard Packing
			Value	Unit			L/W	Thick.			
50V	C0603NP0509□GTQ	1V, 1MHz	5.0	pF	±0.5pF, ±0.25pF, ±0.1pF	0.30	±0.03	±0.03	177	180	Paper, 15Kpcs
	C0603NP0519□GTQ	1V, 1MHz	5.1	pF	±0.5pF, ±0.25pF, ±0.1pF	0.30	±0.03	±0.03	173	180	
	C0603NP0569□GTQ	1V, 1MHz	5.6	pF	±0.5pF, ±0.25pF, ±0.1pF	0.30	±0.03	±0.03	158	180	
	C0603NP0609□GTQ	1V, 1MHz	6.0	pF	±0.5pF, ±0.25pF, ±0.1pF	0.30	±0.03	±0.03	147	180	
	C0603NP0629□GTQ	1V, 1MHz	6.2	pF	±0.5pF, ±0.25pF, ±0.1pF	0.30	±0.03	±0.03	143	180	
	C0603NP0689□GTQ	1V, 1MHz	6.8	pF	±0.5pF, ±0.25pF, ±0.1pF	0.30	±0.03	±0.03	130	180	
	C0603NP0709□GTQ	1V, 1MHz	7.0	pF	±0.5pF, ±0.25pF, ±0.1pF	0.30	±0.03	±0.03	189	120	
	C0603NP0759□GTQ	1V, 1MHz	7.5	pF	±0.5pF, ±0.25pF, ±0.1pF	0.30	±0.03	±0.03	177	120	
	C0603NP0829□GTQ	1V, 1MHz	8.2	pF	±0.5pF, ±0.25pF, ±0.1pF	0.30	±0.03	±0.03	162	120	
	C0603NP0909□GTQ	1V, 1MHz	9.0	pF	±0.5pF, ±0.25pF, ±0.1pF	0.30	±0.03	±0.03	147	120	
	C0603NP0919□GTQ	1V, 1MHz	9.1	pF	±0.5pF, ±0.25pF, ±0.1pF	0.30	±0.03	±0.03	146	120	
	C0603NP0100□GTQ	1V, 1MHz	10	pF	±5%, ±2%	0.30	±0.03	±0.03	133	120	
	C0603NP0110□GTQ	1V, 1MHz	11	pF	±5%, ±2%	0.30	±0.03	±0.03	138	105	
	C0603NP0120□GTQ	1V, 1MHz	12	pF	±5%, ±2%	0.30	±0.03	±0.03	147	90	
	C0603NP0130□GTQ	1V, 1MHz	13	pF	±5%, ±2%	0.30	±0.03	±0.03	153	80	
	C0603NP0150□GTQ	1V, 1MHz	15	pF	±5%, ±2%	0.30	±0.03	±0.03	152	70	
	C0603NP0160□GTQ	1V, 1MHz	16	pF	±5%, ±2%	0.30	±0.03	±0.03	166	60	
	C0603NP0180□GTQ	1V, 1MHz	18	pF	±5%, ±2%	0.30	±0.03	±0.03	147	60	
C0603NP0200□GTQ	1V, 1MHz	20	pF	±5%, ±2%	0.30	±0.03	±0.03	199	40		
C0603NP0220□GTQ	1V, 1MHz	22	pF	±5%, ±2%, ±1%	0.30	±0.03	±0.03	207	35		
25V	C0603NP0208□FTQ	1V, 1MHz	0.2	pF	±0.25pF, ±0.1pF, ±0.05pF	0.30	±0.03	±0.03	2274	350	Paper, 15Kpcs
	C0603NP0308□FTQ	1V, 1MHz	0.3	pF	±0.25pF, ±0.1pF, ±0.05pF	0.30	±0.03	±0.03	1516	350	
	C0603NP0408□FTQ	1V, 1MHz	0.4	pF	±0.25pF, ±0.1pF, ±0.05pF	0.30	±0.03	±0.03	1137	350	
	C0603NP0508□FTQ	1V, 1MHz	0.5	pF	±0.25pF, ±0.1pF, ±0.05pF	0.30	±0.03	±0.03	909	350	
	C0603NP0608□FTQ	1V, 1MHz	0.6	pF	±0.25pF, ±0.1pF, ±0.05pF	0.30	±0.03	±0.03	758	350	
	C0603NP0708□FTQ	1V, 1MHz	0.7	pF	±0.25pF, ±0.1pF, ±0.05pF	0.30	±0.03	±0.03	650	350	
	C0603NP0758□FTQ	1V, 1MHz	0.75	pF	±0.25pF, ±0.1pF, ±0.05pF	0.30	±0.03	±0.03	606	350	
	C0603NP0808□FTQ	1V, 1MHz	0.8	pF	±0.25pF, ±0.1pF, ±0.05pF	0.30	±0.03	±0.03	568	350	
	C0603NP0908□FTQ	1V, 1MHz	0.9	pF	±0.25pF, ±0.1pF, ±0.05pF	0.30	±0.03	±0.03	505	350	
	C0603NP0109□FTQ	1V, 1MHz	1.0	pF	±0.25pF, ±0.1pF, ±0.05pF	0.30	±0.03	±0.03	455	350	
	C0603NP0119□FTQ	1V, 1MHz	1.1	pF	±0.25pF, ±0.1pF, ±0.05pF	0.30	±0.03	±0.03	482	300	
	C0603NP0129□FTQ	1V, 1MHz	1.2	pF	±0.25pF, ±0.1pF, ±0.05pF	0.30	±0.03	±0.03	442	300	
	C0603NP0139□FTQ	1V, 1MHz	1.3	pF	±0.25pF, ±0.1pF, ±0.05pF	0.30	±0.03	±0.03	408	300	
	C0603NP0149□FTQ	1V, 1MHz	1.4	pF	±0.25pF, ±0.1pF, ±0.05pF	0.30	±0.03	±0.03	379	300	
	C0603NP0159□FTQ	1V, 1MHz	1.5	pF	±0.25pF, ±0.1pF, ±0.05pF	0.30	±0.03	±0.03	354	300	
	C0603NP0169□FTQ	1V, 1MHz	1.6	pF	±0.25pF, ±0.1pF, ±0.05pF	0.30	±0.03	±0.03	332	300	
	C0603NP0189□FTQ	1V, 1MHz	1.8	pF	±0.25pF, ±0.1pF, ±0.05pF	0.30	±0.03	±0.03	295	300	
	C0603NP0209□FTQ	1V, 1MHz	2.0	pF	±0.25pF, ±0.1pF, ±0.05pF	0.30	±0.03	±0.03	318	250	
	C0603NP0229□FTQ	1V, 1MHz	2.2	pF	±0.25pF, ±0.1pF, ±0.05pF	0.30	±0.03	±0.03	289	250	
	C0603NP0249□FTQ	1V, 1MHz	2.4	pF	±0.25pF, ±0.1pF, ±0.05pF	0.30	±0.03	±0.03	265	250	
	C0603NP0259□FTQ	1V, 1MHz	2.5	pF	±0.25pF, ±0.1pF, ±0.05pF	0.30	±0.03	±0.03	255	250	
	C0603NP0279□FTQ	1V, 1MHz	2.7	pF	±0.25pF, ±0.1pF, ±0.05pF	0.30	±0.03	±0.03	236	250	
	C0603NP0309□FTQ	1V, 1MHz	3.0	pF	±0.25pF, ±0.1pF, ±0.05pF	0.30	±0.03	±0.03	265	200	
	C0603NP0339□FTQ	1V, 1MHz	3.3	pF	±0.25pF, ±0.1pF, ±0.05pF	0.30	±0.03	±0.03	241	200	
	C0603NP0369□FTQ	1V, 1MHz	3.6	pF	±0.25pF, ±0.1pF, ±0.05pF	0.30	±0.03	±0.03	221	200	
	C0603NP0399□FTQ	1V, 1MHz	3.9	pF	±0.25pF, ±0.1pF, ±0.05pF	0.30	±0.03	±0.03	204	200	
	C0603NP0439□FTQ	1V, 1MHz	4.3	pF	±0.25pF, ±0.1pF, ±0.05pF	0.30	±0.03	±0.03	185	200	
	C0603NP0479□FTQ	1V, 1MHz	4.7	pF	±0.25pF, ±0.1pF, ±0.05pF	0.30	±0.03	±0.03	169	200	
	C0603NP0509□FTQ	1V, 1MHz	5.0	pF	±0.5pF, ±0.25pF, ±0.1pF	0.30	±0.03	±0.03	177	180	
	C0603NP0519□FTQ	1V, 1MHz	5.1	pF	±0.5pF, ±0.25pF, ±0.1pF	0.30	±0.03	±0.03	173	180	
	C0603NP0569□FTQ	1V, 1MHz	5.6	pF	±0.5pF, ±0.25pF, ±0.1pF	0.30	±0.03	±0.03	158	180	
	C0603NP0609□FTQ	1V, 1MHz	6.0	pF	±0.5pF, ±0.25pF, ±0.1pF	0.30	±0.03	±0.03	147	180	
	C0603NP0629□FTQ	1V, 1MHz	6.2	pF	±0.5pF, ±0.25pF, ±0.1pF	0.30	±0.03	±0.03	143	180	
	C0603NP0689□FTQ	1V, 1MHz	6.8	pF	±0.5pF, ±0.25pF, ±0.1pF	0.30	±0.03	±0.03	130	180	
	C0603NP0709□FTQ	1V, 1MHz	7.0	pF	±0.5pF, ±0.25pF, ±0.1pF	0.30	±0.03	±0.03	189	120	
	C0603NP0759□FTQ	1V, 1MHz	7.5	pF	±0.5pF, ±0.25pF, ±0.1pF	0.30	±0.03	±0.03	177	120	
	C0603NP0829□FTQ	1V, 1MHz	8.2	pF	±0.5pF, ±0.25pF, ±0.1pF	0.30	±0.03	±0.03	162	120	
	C0603NP0909□FTQ	1V, 1MHz	9.0	pF	±0.5pF, ±0.25pF, ±0.1pF	0.30	±0.03	±0.03	147	120	
	C0603NP0919□FTQ	1V, 1MHz	9.1	pF	±0.5pF, ±0.25pF, ±0.1pF	0.30	±0.03	±0.03	146	120	
	C0603NP0959□FTQ	1V, 1MHz	9.5	pF	±0.5pF, ±0.25pF, ±0.1pF	0.30	±0.03	±0.03	140	120	
	C0603NP0100□FTQ	1V, 1MHz	10	pF	±5%, ±2%	0.30	±0.03	±0.03	133	120	
	C0603NP0110□FTQ	1V, 1MHz	11	pF	±5%, ±2%	0.30	±0.03	±0.03	138	105	
C0603NP0120□FTQ	1V, 1MHz	12	pF	±5%, ±2%	0.30	±0.03	±0.03	147	90		
C0603NP0130□FTQ	1V, 1MHz	13	pF	±5%, ±2%	0.30	±0.03	±0.03	153	80		
C0603NP0150□FTQ	1V, 1MHz	15	pF	±5%, ±2%	0.30	±0.03	±0.03	152	70		
C0603NP0160□FTQ	1V, 1MHz	16	pF	±5%, ±2%	0.30	±0.03	±0.03	166	60		
C0603NP0180□FTQ	1V, 1MHz	18	pF	±5%, ±2%	0.30	±0.03	±0.03	147	60		
C0603NP0200□FTQ	1V, 1MHz	20	pF	±5%, ±2%	0.30	±0.03	±0.03	199	40		
C0603NP0220□FTQ	1V, 1MHz	22	pF	±5%, ±2%, ±1%	0.30	±0.03	±0.03	207	35		

● C1005NP0_Q Series (EIA0402)

RV	DARFON P/N	Measuring Condition	Capacitance		Available Tolerance	Thick. (mm)	Tolerance(mm)		ESR(1GHz) mΩ (max.)	Q(1GHz) (min.)	Standard Packing
			Value	Unit			L/W	Thick.			
100V	C1005NP0308□HTQ	1V, 1MHz	0.3	pF	±0.25pF, ±0.1pF, ±0.05pF	0.50	±0.05	±0.05	1768	300	Paper, 10Kpcs
	C1005NP0109□HTQ	1V, 1MHz	1.0	pF	±0.25pF, ±0.1pF, ±0.05pF	0.50	±0.05	±0.05	531	300	
50V	C1005NP0108BGTQ	1V, 1MHz	0.1	pF	±0.1pF	0.50	±0.05	±0.05	5305	300	Paper, 10Kpcs
	C1005NP0208□GTQ	1V, 1MHz	0.2	pF	±0.25pF, ±0.1pF, ±0.05pF	0.50	±0.05	±0.05	2653	300	
	C1005NP0308□GTQ	1V, 1MHz	0.3	pF	±0.25pF, ±0.1pF, ±0.05pF	0.50	±0.05	±0.05	1768	300	
	C1005NP0408□GTQ	1V, 1MHz	0.4	pF	±0.25pF, ±0.1pF, ±0.05pF	0.50	±0.05	±0.05	1326	300	
	C1005NP0508□GTQ	1V, 1MHz	0.5	pF	±0.25pF, ±0.1pF, ±0.05pF	0.50	±0.05	±0.05	1061	300	
	C1005NP0568□GTQ	1V, 1MHz	0.56	pF	±0.25pF, ±0.1pF, ±0.05pF	0.50	±0.05	±0.05	947	300	
	C1005NP0608□GTQ	1V, 1MHz	0.6	pF	±0.25pF, ±0.1pF, ±0.05pF	0.50	±0.05	±0.05	884	300	
	C1005NP0708□GTQ	1V, 1MHz	0.7	pF	±0.25pF, ±0.1pF, ±0.05pF	0.50	±0.05	±0.05	758	300	
	C1005NP0758□GTQ	1V, 1MHz	0.75	pF	±0.25pF, ±0.1pF, ±0.05pF	0.50	±0.05	±0.05	707	300	
	C1005NP0808□GTQ	1V, 1MHz	0.8	pF	±0.25pF, ±0.1pF, ±0.05pF	0.50	±0.05	±0.05	663	300	
	C1005NP0828□GTQ	1V, 1MHz	0.82	pF	±0.25pF, ±0.1pF, ±0.05pF	0.50	±0.05	±0.05	647	300	
	C1005NP0908□GTQ	1V, 1MHz	0.9	pF	±0.25pF, ±0.1pF, ±0.05pF	0.50	±0.05	±0.05	589	300	
	C1005NP0109□GTQ	1V, 1MHz	1.0	pF	±0.25pF, ±0.1pF, ±0.05pF	0.50	±0.05	±0.05	531	300	
	C1005NP0119□GTQ	1V, 1MHz	1.1	pF	±0.25pF, ±0.1pF, ±0.05pF	0.50	±0.05	±0.05	482	300	
	C1005NP0129□GTQ	1V, 1MHz	1.2	pF	±0.25pF, ±0.1pF, ±0.05pF	0.50	±0.05	±0.05	531	250	
	C1005NP0139□GTQ	1V, 1MHz	1.3	pF	±0.25pF, ±0.1pF, ±0.05pF	0.50	±0.05	±0.05	490	250	
	C1005NP0159□GTQ	1V, 1MHz	1.5	pF	±0.25pF, ±0.1pF, ±0.05pF	0.50	±0.05	±0.05	424	250	
	C1005NP0169□GTQ	1V, 1MHz	1.6	pF	±0.25pF, ±0.1pF, ±0.05pF	0.50	±0.05	±0.05	398	250	
	C1005NP0189□GTQ	1V, 1MHz	1.8	pF	±0.25pF, ±0.1pF, ±0.05pF	0.50	±0.05	±0.05	354	250	
	C1005NP0209□GTQ	1V, 1MHz	2.0	pF	±0.25pF, ±0.1pF, ±0.05pF	0.50	±0.05	±0.05	398	200	
	C1005NP0229□GTQ	1V, 1MHz	2.2	pF	±0.25pF, ±0.1pF, ±0.05pF	0.50	±0.05	±0.05	362	200	
	C1005NP0249□GTQ	1V, 1MHz	2.4	pF	±0.25pF, ±0.1pF, ±0.05pF	0.50	±0.05	±0.05	332	200	
	C1005NP0279□GTQ	1V, 1MHz	2.7	pF	±0.25pF, ±0.1pF, ±0.05pF	0.50	±0.05	±0.05	295	200	
	C1005NP0299□GTQ	1V, 1MHz	2.9	pF	±0.25pF, ±0.1pF, ±0.05pF	0.50	±0.05	±0.05	274	200	
	C1005NP0309□GTQ	1V, 1MHz	3.0	pF	±0.25pF, ±0.1pF, ±0.05pF	0.50	±0.05	±0.05	265	200	
	C1005NP0339□GTQ	1V, 1MHz	3.3	pF	±0.25pF, ±0.1pF, ±0.05pF	0.50	±0.05	±0.05	241	200	
	C1005NP0369□GTQ	1V, 1MHz	3.6	pF	±0.25pF, ±0.1pF, ±0.05pF	0.50	±0.05	±0.05	246	180	
	C1005NP0399□GTQ	1V, 1MHz	3.9	pF	±0.25pF, ±0.1pF, ±0.05pF	0.50	±0.05	±0.05	227	180	
	C1005NP0409□GTQ	1V, 1MHz	4.0	pF	±0.25pF, ±0.1pF, ±0.05pF	0.50	±0.05	±0.05	221	180	
	C1005NP0439□GTQ	1V, 1MHz	4.3	pF	±0.25pF, ±0.1pF	0.50	±0.05	±0.05	206	180	
	C1005NP0479□GTQ	1V, 1MHz	4.7	pF	±0.25pF, ±0.1pF, ±0.05pF	0.50	±0.05	±0.05	188	180	
	C1005NP0509□GTQ	1V, 1MHz	5.0	pF	±0.5pF, ±0.25pF, ±0.1pF	0.50	±0.05	±0.05	212	150	
	C1005NP0519□GTQ	1V, 1MHz	5.1	pF	±0.5pF, ±0.25pF, ±0.1pF	0.50	±0.05	±0.05	208	150	
	C1005NP0569□GTQ	1V, 1MHz	5.6	pF	±0.5pF, ±0.25pF, ±0.1pF	0.50	±0.05	±0.05	189	150	
C1005NP0609□GTQ	1V, 1MHz	6.0	pF	±0.5pF, ±0.25pF, ±0.1pF	0.50	±0.05	±0.05	177	150		
C1005NP0629□GTQ	1V, 1MHz	6.2	pF	±0.5pF, ±0.25pF, ±0.1pF	0.50	±0.05	±0.05	171	150		
C1005NP0689□GTQ	1V, 1MHz	6.8	pF	±0.5pF, ±0.25pF, ±0.1pF	0.50	±0.05	±0.05	156	150		
C1005NP0709□GTQ	1V, 1MHz	7.0	pF	±0.5pF, ±0.25pF, ±0.1pF	0.50	±0.05	±0.05	227	100		
C1005NP0759□GTQ	1V, 1MHz	7.5	pF	±0.5pF, ±0.25pF, ±0.1pF	0.50	±0.05	±0.05	212	100		
C1005NP0809□GTQ	1V, 1MHz	8.0	pF	±0.5pF, ±0.25pF, ±0.1pF	0.50	±0.05	±0.05	199	100		
C1005NP0829□GTQ	1V, 1MHz	8.2	pF	±0.5pF, ±0.25pF, ±0.1pF	0.50	±0.05	±0.05	194	100		
C1005NP0909□GTQ	1V, 1MHz	9.0	pF	±0.5pF, ±0.25pF, ±0.1pF	0.50	±0.05	±0.05	177	100		
C1005NP0919□GTQ	1V, 1MHz	9.1	pF	±0.5pF, ±0.25pF, ±0.1pF	0.50	±0.05	±0.05	175	100		
C1005NP0959□GTQ	1V, 1MHz	9.5	pF	±0.5pF, ±0.25pF, ±0.1pF	0.50	±0.05	±0.05	186	90		
C1005NP0100□GTQ	1V, 1MHz	10	pF	±5%, ±2%	0.50	±0.05	±0.05	199	80		
C1005NP0110□GTQ	1V, 1MHz	11	pF	±5%, ±2%	0.50	±0.05	±0.05	207	70		
C1005NP0120□GTQ	1V, 1MHz	12	pF	±5%, ±2%	0.50	±0.05	±0.05	221	60		
C1005NP0150□GTQ	1V, 1MHz	15	pF	±5%, ±2%, ±1%	0.50	±0.05	±0.05	265	40		
C1005NP0160□GTQ	1V, 1MHz	16	pF	±5%, ±2%, ±1%	0.50	±0.05	±0.05	284	35		
C1005NP0180□GTQ	1V, 1MHz	18	pF	±5%, ±2%	0.50	±0.05	±0.05	295	30		
C1005NP0200□GTQ	1V, 1MHz	20	pF	±5%, ±2%	0.50	±0.05	±0.05	398	20		
C1005NP0220□GTQ	1V, 1MHz	22	pF	±5%, ±2%	0.50	±0.05	±0.05	362	20		
25V	C1005NP0508BFTQ	1V, 1MHz	0.5	pF	±0.1pF	0.50	±0.05	±0.05	1061	300	Paper, 10Kpcs
	C1005NP0209BFTQ	1V, 1MHz	2.0	pF	±0.1pF	0.50	±0.05	±0.05	398	200	
	C1005NP0479CFTQ	1V, 1MHz	4.7	pF	±0.25pF	0.50	±0.05	±0.05	188	180	
16V	C1005NP0109BETQ	1V, 1MHz	1.0	pF	±0.1pF	0.50	±0.05	±0.05	531	300	Paper, 10Kpcs

□ Tolerance Code: A=±0.05 pF, B=±0.1pF, C=±0.25pF, D=±0.5pF, G=±2%, J=±5%; Special tolerance on the request.

● C1608NP0_Q Series (EIA0603)

RV	DARFON P/N	Measuring Condition	Capacitance		Available Tolerance	Thick. (mm)	Tolerance(mm)		ESR(1GHz) mΩ (max.)	Q(1GHz) (min.)	Standard Packing
			Value	Unit			L/W	Thick.			
250V	C1608NP0308□KTQ	1V, 1MHz	0.3	pF	±0.25pF,±0.1pF, ±0.05pF	0.80	±0.10	±0.10	2122	250	Paper, 4Kpcs
	C1608NP0508□KTQ	1V, 1MHz	0.5	pF	±0.25pF,±0.1pF, ±0.05pF	0.80	±0.10	±0.10	1273	250	
	C1608NP0758□KTQ	1V, 1MHz	0.75	pF	±0.25pF,±0.1pF, ±0.05pF	0.80	±0.10	±0.10	849	250	
	C1608NP0808□KTQ	1V, 1MHz	0.8	pF	±0.25pF,±0.1pF, ±0.05pF	0.80	±0.10	±0.10	796	250	
	C1608NP0109□KTQ	1V, 1MHz	1.0	pF	±0.25pF,±0.1pF, ±0.05pF	0.80	±0.10	±0.10	637	250	
	C1608NP0129□KTQ	1V, 1MHz	1.2	pF	±0.25pF,±0.1pF, ±0.05pF	0.80	±0.10	±0.10	663	200	
	C1608NP0159□KTQ	1V, 1MHz	1.5	pF	±0.25pF,±0.1pF, ±0.05pF	0.80	±0.10	±0.10	531	200	
	C1608NP0189□KTQ	1V, 1MHz	1.8	pF	±0.25pF,±0.1pF, ±0.05pF	0.80	±0.10	±0.10	442	200	
	C1608NP0209□KTQ	1V, 1MHz	2.0	pF	±0.25pF,±0.1pF, ±0.05pF	0.80	±0.10	±0.10	531	150	
	C1608NP0229□KTQ	1V, 1MHz	2.2	pF	±0.25pF,±0.1pF, ±0.05pF	0.80	±0.10	±0.10	482	150	
	C1608NP0249□KTQ	1V, 1MHz	2.4	pF	±0.25pF,±0.1pF, ±0.05pF	0.80	±0.10	±0.10	442	150	
	C1608NP0279□KTQ	1V, 1MHz	2.7	pF	±0.25pF,±0.1pF, ±0.05pF	0.80	±0.10	±0.10	393	150	
	C1608NP0309□KTQ	1V, 1MHz	3.0	pF	±0.25pF,±0.1pF, ±0.05pF	0.80	±0.10	±0.10	531	100	
	C1608NP0339□KTQ	1V, 1MHz	3.3	pF	±0.25pF,±0.1pF, ±0.05pF	0.80	±0.10	±0.10	482	100	
	C1608NP0399□KTQ	1V, 1MHz	3.9	pF	±0.25pF,±0.1pF, ±0.05pF	0.80	±0.10	±0.10	408	100	
	C1608NP0479□KTQ	1V, 1MHz	4.7	pF	±0.25pF,±0.1pF, ±0.05pF	0.80	±0.10	±0.10	339	100	
	C1608NP0519□KTQ	1V, 1MHz	5.1	pF	±0.25pF,±0.1pF, ±0.05pF	0.80	±0.10	±0.10	347	90	
	C1608NP0569□KTQ	1V, 1MHz	5.6	pF	±0.5pF, ±0.25pF,±0.1pF	0.80	±0.10	±0.10	355	80	
	C1608NP0609□KTQ	1V, 1MHz	6.0	pF	±0.5pF, ±0.25pF,±0.1pF	0.80	±0.10	±0.10	332	80	
	C1608NP0689□KTQ	1V, 1MHz	6.8	pF	±0.5pF, ±0.25pF,±0.1pF	0.80	±0.10	±0.10	293	80	
	C1608NP0829□KTQ	1V, 1MHz	8.2	pF	±0.5pF, ±0.25pF,±0.1pF	0.80	±0.10	±0.10	277	70	
	C1608NP0919□KTQ	1V, 1MHz	9.1	pF	±0.5pF, ±0.25pF,±0.1pF	0.80	±0.10	±0.10	250	70	
C1608NP0100□KTQ	1V, 1MHz	10	pF	±5%,±2%	0.80	±0.10	±0.10	227	70		
C1608NP0120JKTQ	1V, 1MHz	12	pF	±5%	0.80	±0.10	±0.10	332	40		
C1608NP0150□KTQ	1V, 1MHz	15	pF	±5%,±2%	0.80	±0.10	±0.10	303	35		
C1608NP0180□KTQ	1V, 1MHz	18	pF	±5%,±2%	0.80	±0.10	±0.10	295	30		
C1608NP0220□KTQ	1V, 1MHz	22	pF	±5%,±2%	0.80	±0.10	±0.10	289	25		
200V	C1608NP0129BJTQ	1V, 1MHz	1.2	pF	±0.1pF	0.80	±0.10	±0.10	663	200	Paper, 4Kpcs
	C1608NP0159BJTQ	1V, 1MHz	1.5	pF	±0.1pF	0.80	±0.10	±0.10	531	200	
	C1608NP0189BJTQ	1V, 1MHz	1.8	pF	±0.1pF	0.80	±0.10	±0.10	442	200	
	C1608NP0229BJTQ	1V, 1MHz	2.2	pF	±0.1pF	0.80	±0.10	±0.10	482	150	
	C1608NP0249□JTTQ	1V, 1MHz	2.4	pF	±0.25pF,±0.1pF, ±0.05pF	0.80	±0.10	±0.10	442	150	
	C1608NP0279BJTQ	1V, 1MHz	2.7	pF	±0.1pF	0.80	±0.10	±0.10	393	150	
	C1608NP0309BJTQ	1V, 1MHz	3.0	pF	±0.1pF	0.80	±0.10	±0.10	531	100	
	C1608NP0339BJTQ	1V, 1MHz	3.3	pF	±0.1pF	0.80	±0.10	±0.10	482	100	
	C1608NP0399BJTQ	1V, 1MHz	3.9	pF	±0.1pF	0.80	±0.10	±0.10	408	100	
	C1608NP0439BJTQ	1V, 1MHz	4.3	pF	±0.1pF	0.80	±0.10	±0.10	370	100	
	C1608NP0479□JTTQ	1V, 1MHz	4.7	pF	±0.25pF,±0.1pF, ±0.05pF	0.80	±0.10	±0.10	339	100	
	C1608NP0519□JTTQ	1V, 1MHz	5.1	pF	±0.25pF,±0.1pF, ±0.05pF	0.80	±0.10	±0.10	347	90	
	C1608NP0689BJTQ	1V, 1MHz	6.8	pF	±0.1pF	0.80	±0.10	±0.10	293	80	
C1608NP0829CJTTQ	1V, 1MHz	8.2	pF	±0.25pF	0.80	±0.10	±0.10	277	70		
100V	C1608NP0308□HTQ	1V, 1MHz	0.3	pF	±0.25pF,±0.1pF, ±0.05pF	0.80	±0.10	±0.10	2122	250	Paper, 4Kpcs
	C1608NP0508□HTQ	1V, 1MHz	0.5	pF	±0.25pF,±0.1pF, ±0.05pF	0.80	±0.10	±0.10	1273	250	
	C1608NP0758□HTQ	1V, 1MHz	0.75	pF	±0.25pF,±0.1pF, ±0.05pF	0.80	±0.10	±0.10	849	250	
	C1608NP0109□HTQ	1V, 1MHz	1.0	pF	±0.25pF,±0.1pF, ±0.05pF	0.80	±0.10	±0.10	637	250	
	C1608NP0129□HTQ	1V, 1MHz	1.2	pF	±0.25pF,±0.1pF, ±0.05pF	0.80	±0.10	±0.10	663	200	
	C1608NP0159□HTQ	1V, 1MHz	1.5	pF	±0.25pF,±0.1pF, ±0.05pF	0.80	±0.10	±0.10	531	200	
	C1608NP0189□HTQ	1V, 1MHz	1.8	pF	±0.25pF,±0.1pF, ±0.05pF	0.80	±0.10	±0.10	442	200	
	C1608NP0209□HTQ	1V, 1MHz	2.0	pF	±0.25pF,±0.1pF, ±0.05pF	0.80	±0.10	±0.10	531	150	
	C1608NP0229□HTQ	1V, 1MHz	2.2	pF	±0.25pF,±0.1pF, ±0.05pF	0.80	±0.10	±0.10	482	150	
	C1608NP0249□HTQ	1V, 1MHz	2.4	pF	±0.25pF,±0.1pF, ±0.05pF	0.80	±0.10	±0.10	442	150	
	C1608NP0279□HTQ	1V, 1MHz	2.7	pF	±0.25pF,±0.1pF, ±0.05pF	0.80	±0.10	±0.10	393	150	
	C1608NP0309□HTQ	1V, 1MHz	3.0	pF	±0.25pF,±0.1pF, ±0.05pF	0.80	±0.10	±0.10	531	100	
	C1608NP0339□HTQ	1V, 1MHz	3.3	pF	±0.25pF,±0.1pF, ±0.05pF	0.80	±0.10	±0.10	482	100	
	C1608NP0399□HTQ	1V, 1MHz	3.9	pF	±0.25pF,±0.1pF, ±0.05pF	0.80	±0.10	±0.10	408	100	
	C1608NP0479□HTQ	1V, 1MHz	4.7	pF	±0.25pF,±0.1pF, ±0.05pF	0.80	±0.10	±0.10	339	100	
	C1608NP0569□HTQ	1V, 1MHz	5.6	pF	±0.5pF, ±0.25pF,±0.1pF	0.80	±0.10	±0.10	355	80	
	C1608NP0609□HTQ	1V, 1MHz	6.0	pF	±0.5pF, ±0.25pF,±0.1pF	0.80	±0.10	±0.10	332	80	
	C1608NP0689□HTQ	1V, 1MHz	6.8	pF	±0.5pF, ±0.25pF,±0.1pF	0.80	±0.10	±0.10	293	80	
	C1608NP0829□HTQ	1V, 1MHz	8.2	pF	±0.5pF, ±0.25pF,±0.1pF	0.80	±0.10	±0.10	277	70	
	C1608NP0919□HTQ	1V, 1MHz	9.1	pF	±0.5pF, ±0.25pF,±0.1pF	0.80	±0.10	±0.10	250	70	
	C1608NP0100JHTQ	1V, 1MHz	10	pF	±5%	0.80	±0.10	±0.10	227	70	
	C1608NP0120JHTQ	1V, 1MHz	12	pF	±5%	0.80	±0.10	±0.10	332	40	
C1608NP0150JHTQ	1V, 1MHz	15	pF	±5%	0.80	±0.10	±0.10	303	35		
C1608NP0180JHTQ	1V, 1MHz	18	pF	±5%	0.80	±0.10	±0.10	295	30		
C1608NP0220JHTQ	1V, 1MHz	22	pF	±5%	0.80	±0.10	±0.10	289	25		

RV	DARFON P/N	Measuring Condition	Capacitance		Available Tolerance	Thick. (mm)	Tolerance(mm)		ESR(1GHz) mΩ (max.)	Q(1GHz) (min.)	Standard Packing
			Value	Unit			L/W	Thick.			
50V	C1608NP0208□GTQ	1V, 1MHz	0.20	pF	±0.25pF±0.1pF, ±0.05pF	0.80	±0.10	±0.10	3183	250	Paper, 4Kpcs
	C1608NP0228□GTQ	1V, 1MHz	0.22	pF	±0.25pF±0.1pF, ±0.05pF	0.80	±0.10	±0.10	2894	250	
	C1608NP0308□GTQ	1V, 1MHz	0.30	pF	±0.25pF±0.1pF, ±0.05pF	0.80	±0.10	±0.10	2122	250	
	C1608NP0508□GTQ	1V, 1MHz	0.50	pF	±0.25pF±0.1pF, ±0.05pF	0.80	±0.10	±0.10	1273	250	
	C1608NP0758□GTQ	1V, 1MHz	0.75	pF	±0.25pF±0.1pF, ±0.05pF	0.80	±0.10	±0.10	849	250	
	C1608NP0109□GTQ	1V, 1MHz	1.0	pF	±0.25pF±0.1pF, ±0.05pF	0.80	±0.10	±0.10	637	250	
	C1608NP0129□GTQ	1V, 1MHz	1.2	pF	±0.25pF, ±0.1pF	0.80	±0.10	±0.10	663	200	
	C1608NP0159□GTQ	1V, 1MHz	1.5	pF	±0.25pF, ±0.1pF	0.80	±0.10	±0.10	531	200	
	C1608NP0189□GTQ	1V, 1MHz	1.8	pF	±0.25pF, ±0.1pF	0.80	±0.10	±0.10	442	200	
	C1608NP0209□GTQ	1V, 1MHz	2.0	pF	±0.25pF, ±0.1pF	0.80	±0.10	±0.10	531	150	
	C1608NP0229□GTQ	1V, 1MHz	2.2	pF	±0.25pF, ±0.1pF	0.80	±0.10	±0.10	482	150	
	C1608NP0249□GTQ	1V, 1MHz	2.4	pF	±0.25pF, ±0.1pF	0.80	±0.10	±0.10	442	150	
	C1608NP0279□GTQ	1V, 1MHz	2.7	pF	±0.25pF, ±0.1pF	0.80	±0.10	±0.10	393	150	
	C1608NP0309□GTQ	1V, 1MHz	3.0	pF	±0.25pF, ±0.1pF	0.80	±0.10	±0.10	531	100	
	C1608NP0339□GTQ	1V, 1MHz	3.3	pF	±0.25pF, ±0.1pF	0.80	±0.10	±0.10	482	100	
	C1608NP0399□GTQ	1V, 1MHz	3.9	pF	±0.25pF, ±0.1pF	0.80	±0.10	±0.10	408	100	
	C1608NP0479□GTQ	1V, 1MHz	4.7	pF	±0.25pF, ±0.1pF	0.80	±0.10	±0.10	339	100	
	C1608NP0509□GTQ	1V, 1MHz	5.0	pF	±0.25pF, ±0.1pF	0.80	±0.10	±0.10	354	90	
	C1608NP0569□GTQ	1V, 1MHz	5.6	pF	±0.5pF, ±0.25pF, ±0.1pF	0.80	±0.10	±0.10	355	80	
	C1608NP0609□GTQ	1V, 1MHz	6.0	pF	±0.5pF, ±0.25pF, ±0.1pF	0.80	±0.10	±0.10	332	80	
	C1608NP0689□GTQ	1V, 1MHz	6.8	pF	±0.5pF, ±0.25pF, ±0.1pF	0.80	±0.10	±0.10	293	80	
	C1608NP0829□GTQ	1V, 1MHz	8.2	pF	±0.5pF, ±0.25pF, ±0.1pF	0.80	±0.10	±0.10	277	70	
C1608NP0919□GTQ	1V, 1MHz	9.1	pF	±0.5pF, ±0.25pF, ±0.1pF	0.80	±0.10	±0.10	250	70		
C1608NP0100JGTQ	1V, 1MHz	10	pF	±5%	0.80	±0.10	±0.10	227	70		
C1608NP0120□GTQ	1V, 1MHz	12	pF	±5%, ±2%, ±1%	0.80	±0.10	±0.10	332	40		
C1608NP0150JGTQ	1V, 1MHz	15	pF	±5%	0.80	±0.10	±0.10	303	35		
C1608NP0180JGTQ	1V, 1MHz	18	pF	±5%	0.80	±0.10	±0.10	295	30		
C1608NP0220JGTQ	1V, 1MHz	22	pF	±5%	0.80	±0.10	±0.10	289	25		

□ Tolerance Code: A=±0.05 pF, B=±0.1pF, C=±0.25pF, D=±0.5pF, G=±2%, J=±5%; Special tolerance on the request.

Item		Specification	Test Method
14	Temperature cycle (Thermal shock)	Appearance	No marking defects
		Cap. Change	NP0 within $\pm 2.5\%$ or 0.25pF (whichever is larger)
		Q	Initial spec.
		I.R.	Initial spec.
15	Humidity load	Appearance	No marking defects
		Cap. Change	NP0 within $\pm 5\%$ or $\pm 0.5\text{pF}$ (whichever is larger)
		Q	200 min.
		I.R.	$I.R. \geq 500\text{M}\Omega$
16	High temperature load life test	Appearance	No marking defects
		Cap. Change	NP0 within $\pm 5\%$ or $\pm 0.5\text{pF}$ (whichever is larger)
		Q	30pF and over : $Q \geq 350$ 10pF and over, 30pF and below : $Q \geq 275+5C/2$ 10pF and below : $Q \geq 200+10C$ C:Nominal Capacitance(pF)
		I.R.	$I.R. \geq 1\text{G}\Omega$
17	ESR & Q	Shown in the table of "Part Number & Characteristic"	Testing frequency is shown in the table of "Part Number & Characteristic"

MLCC High Frequency Application

Package

- Tape and reel packaging**

Tape and reel packaging is currently the most promising system for high-speed production. A typical 180mm (7 inch) diameter reel contains 1,500 to 15,000 capacitors, 250mm (10 inch) contains 10,000 capacitors, and 330mm (13 inch) contains 10,000 to 50,000 capacitors. Three standard sizes are available in taped and reeled package either with paper carrier tapes or embossed tapes.

【Paper tape specifications】

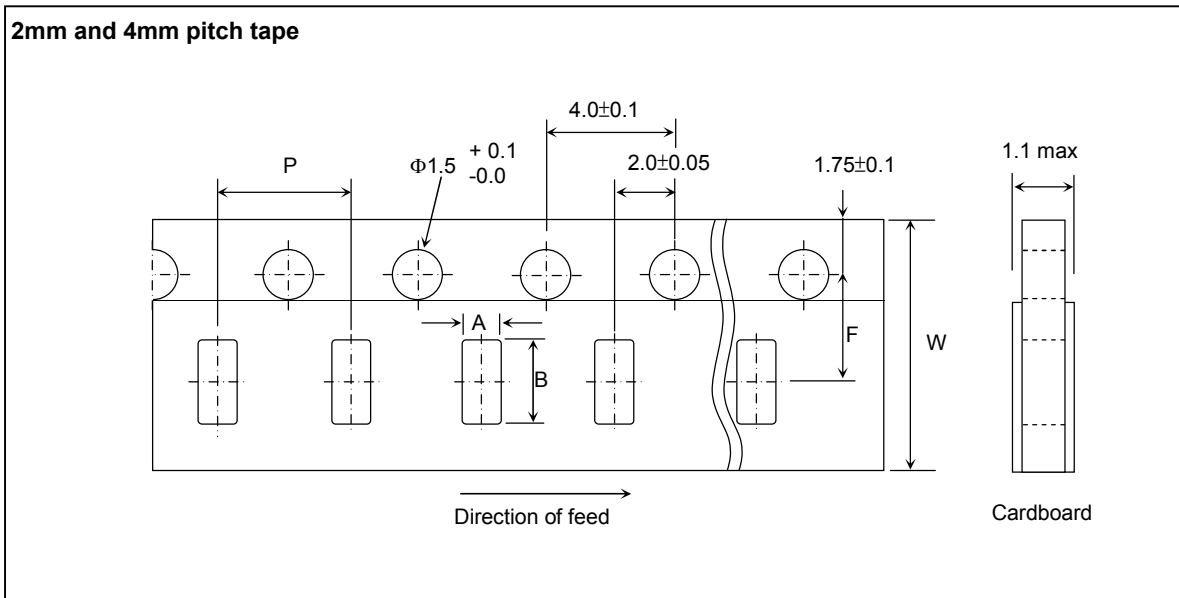

SYMBOL	PRODUCT SIZE CODE						UNIT
	0603(0201)		1005(0402) (± 0.05 mm)		1608 (0603) (± 0.10 mm)		
	SIZE	TOL.	SIZE	TOL.	SIZE	TOL.	
A	0.38	± 0.04	0.65	± 0.10	1.0	± 0.2	mm
B	0.68	± 0.04	1.15	± 0.10	1.8	± 0.2	mm
F	3.5	± 0.05	3.5	± 0.05	3.5	± 0.05	mm
P	2	± 0.10	2	± 0.10	4	± 0.1	mm
W	8	± 0.20	8	± 0.20	8	± 0.2	mm

【Reel specifications】

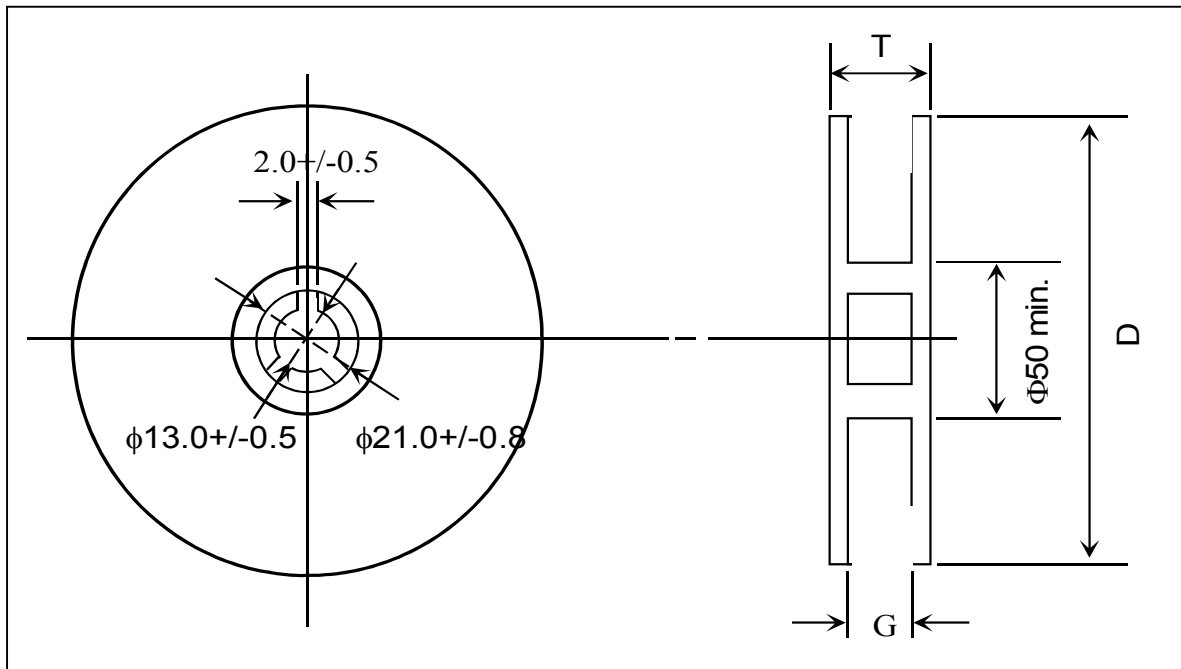

TAPE WIDTH (mm)	G (mm)	T max. (mm)	D (mm)
4	5.0 ± 1.5	8.0	180
8	10.0 ± 1.5	14.5	180
8	10.0 ± 1.5	14.5	250
8	10.0 ± 1.5	14.5	330
12	14.0 ± 1.5	18.5	180

【Thickness and Packing Amount】

Thickness			Amount per reel			
Code	Spec.(mm)	Size (EIA)	180 mm (7")		330 mm (13")	
			Paper	Embossed	Paper	Embossed
A	0.30	0603 (0201)	15K	--	50K	--
B	0.50	1005 (0402)	10K	--	50K	--
D	0.80	1608 (0603)	4K	--	15K	--

【Packing Rule】

EIA SIZE	Tape type	Reel Size	Max Reels/Box
0201	Paper	7"	10
0402	Paper	7"	10
0603	Paper/Emboss	7"	10

*Maximum 60 reels in one carton.

Others

【Storage】

1. The chip capacitors shall be packaged in carrier tapes or bulk cases.
2. Keep storage place temperatures from +5°C to +35°C, humidity from 45 to 70% RH.
3. The storage atmosphere must be free of gas containing sulfur and chlorine. Also, avoid exposing the product to saline moisture. If the product is exposed to such atmospheres, the terminations will oxidize and solderability will be affected.
4. The solderability is assured for 12 months from our final inspection date if the above storage condition is followed.

【Circuit Design】

1. Once application and assembly environments have been checked, the capacitor may be used in conformance with the rating and performance, which are provided in both the catalog and the specifications. Exceeding the specifications listed may result in inferior performance. It may also cause a short, open, smoking, or flaming to occur, etc.
2. Please use the capacitors in conformance with the operating temperature provided in both the catalog and the specifications. Be especially cautious not to exceed the maximum temperature. In the situation the maximum temperature set forth in both the catalog and specifications is exceeded, the capacitor's insulation resistance may deteriorate, power may suddenly surge and short-circuit may occur. The loss of capacitance will occur, and may self-heat due to equivalent series resistance when alternating electric current is passed through. As this effect becomes critical in high frequency circuits, please exercise with caution. When using the capacitor in a (self-heating) circuit, please make sure the surface of the capacitor remains under the maximum temperature for usage. Also, please make certain temperature rise remain below 20°C.
3. Please keep voltage under the rated voltage, which is applied to the capacitor. Also, please make certain the peak voltage remains below the rated voltage when AC voltage is super-imposed to the DC voltage. In the situation where AC or pulse voltage is employed, ensure average peak voltage does not exceed the rated voltage. Exceeding the rated voltage provided in both catalog and specifications may lead to defective withstanding voltage or, in worse case situations, may cause the capacitor to burn out.
4. It's is a common phenomenon of high-dielectric products to have a deteriorated amount of static electricity due to the application of DC voltage.

【Handling】

Chip capacitors should be handled with care to avoid contamination or damage. The use of vacuum pick-up or plastic tweezers is recommended for manual placement. Tape and reeled packages are suitable for automatic pick and placement machine.

【Flux】

1. An excessive amount of flux or too rapid temperature rise can causes solvent burst, solder can generate a large quantity of gas. The gas can spreads small solder particles to cause solder balling effect or bridging problem.
2. Flux containing too high of a percentage of halide may cause corrosion of termination unless sufficient cleaning is applied.
3. Use rosin-type flux. Highly acidic flux (halide content less than 0.2wt%) is not recommended.
4. The water soluble flux causes deteriorated insulation resistance between outer terminations unless sufficiently cleaned.

【Component Spacing】

For wave soldering components, the spacing must be sufficient far apart to prevent bridging or shadowing. This is not so important for reflow process but enough space for rework should be considered. The suggested spacing for reflow soldering and wave soldering is 0.5mm and 1.0mm, respectively.

【Solder Fillet】

Too much solder amount may increase solder stress and cause crack risk. Insufficient solder amount may reduce adhesive Strength and cause parts falling off PCB. When soldering, confirm that the solder is placed over 0.2mm of the surface of the terminations.

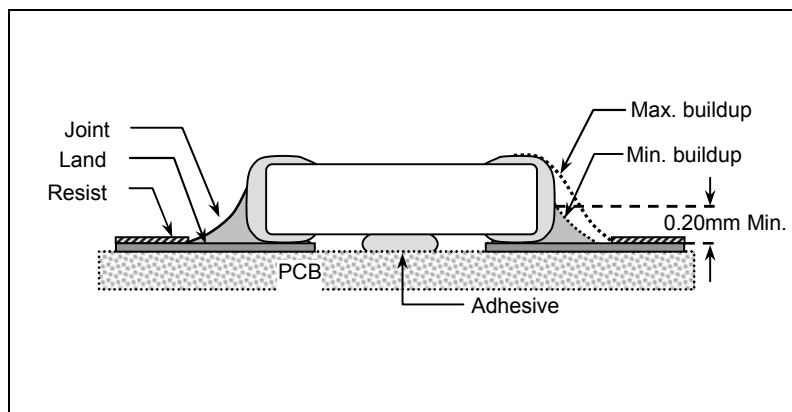

【Recommended Land Pattern Dimensions】

When mounting the capacitor to substrate, it's important to consider that the amount of solder (size of fillet) used has a direct effect upon the capacitor once it's mounted.

1. The greater the amount of solder, the greater the stress to the elements, as this may cause the substrate to break or crack.
2. In the situation where two or more devices are mounted onto a common land, separate the device into exclusive pads by using soldering resist.
3. Land width equal to or less than component. It is permissible to reduce land width to 80% of component width.

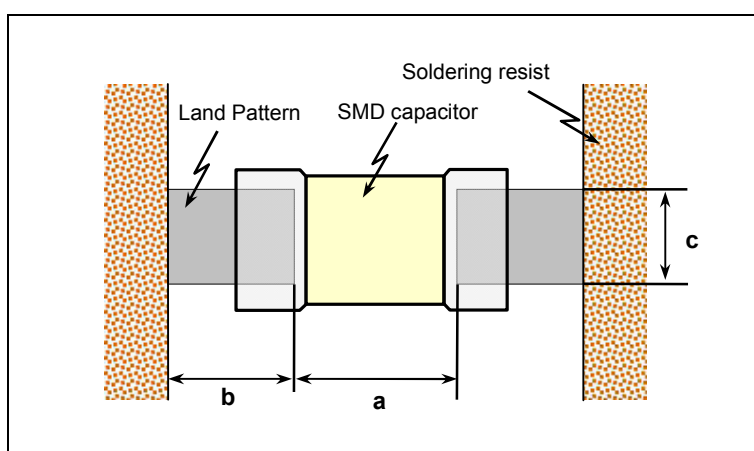

Size mm (EIA)	L x W (mm) (Dimension tolerance)	a (mm)	b (mm)	c (mm)
0603 (0201)	0.6*0.3 (within±0.03)	0.2 to 0.35	0.2 to 0.3	0.2 to 0.4
	0.6*0.3 (±0.05/±0.09)	0.2 to 0.35	0.2 to 0.35	0.25 to 0.4
1005 (0402)	1.0*0.5 (within±0.10)	0.3 to 0.5	0.35 to 0.45	0.4 to 0.6
	1.0*0.5 (±0.15/±0.20)	0.4 to 0.6	0.4 to 0.5	0.5 to 0.7
1608 (0603)	1.6*0.8 (within±0.10)	0.7 to 1.0	0.6 to 0.8	0.7 to 0.8
	1.6*0.8 (±0.15/±0.20/±0.25)	0.8 to 1.1	0.7 to 0.8	0.8 to 1.0

[Resin Mold]

If a large amount of resin is used for molding the chip, cracks may occur due to contraction stress during curing. To avoid such cracks, use a low shrinkage resin. The insulation resistance of the chip will degrade due to moisture absorption. Use a low moisture absorption resin. Check carefully that the resin does not generate a decomposition gas or reaction gas during the curing process or during normal storage. Such gases may crack the chip capacitor or damage the device itself.

[Soldering Profile for SMT Process with SnPb Solder Paste]

Reflow Soldering

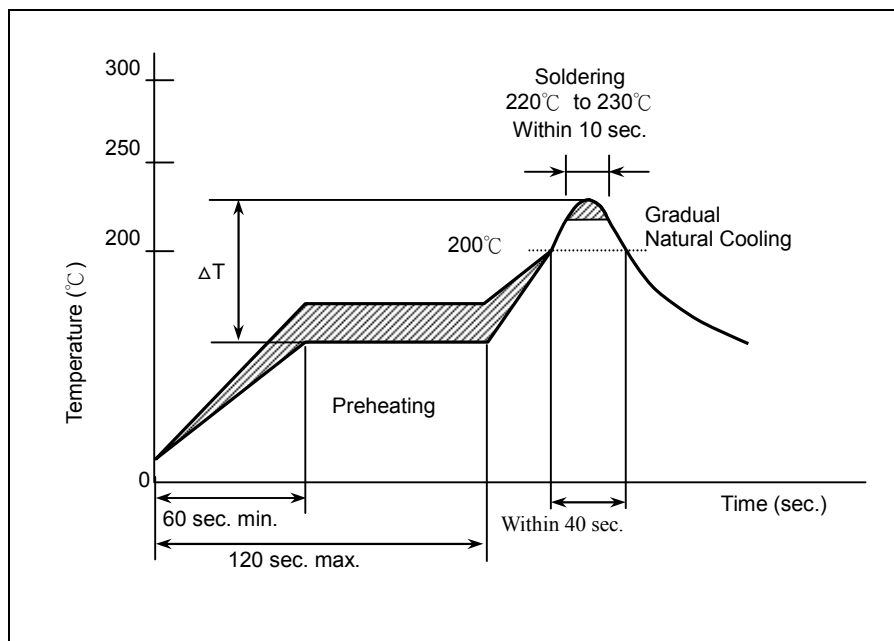

The difference between solder and chip surface should be controlled as following table. The rate of preheat should not exceed 4°C/sec and a target of 2°C/sec is preferred.

Chip Size	3216 and smaller	3225 and above
Preheating	$\Delta T \leq 150^{\circ}\text{C}$	$\Delta T \leq 130^{\circ}\text{C}$

Wave Soldering

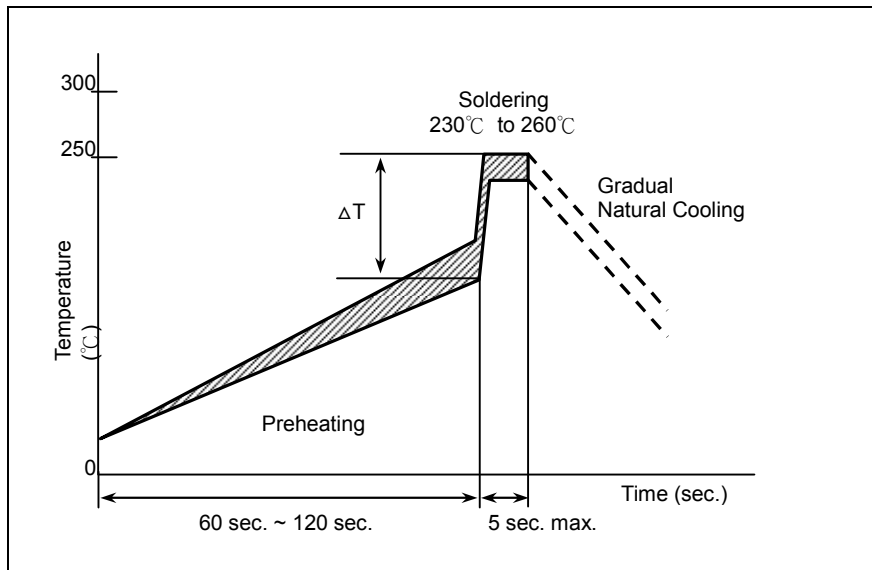

Chip Size	3216 and smaller	3225 and above
Preheating	$\Delta T \leq 150^\circ\text{C}$	-

Soldering Iron

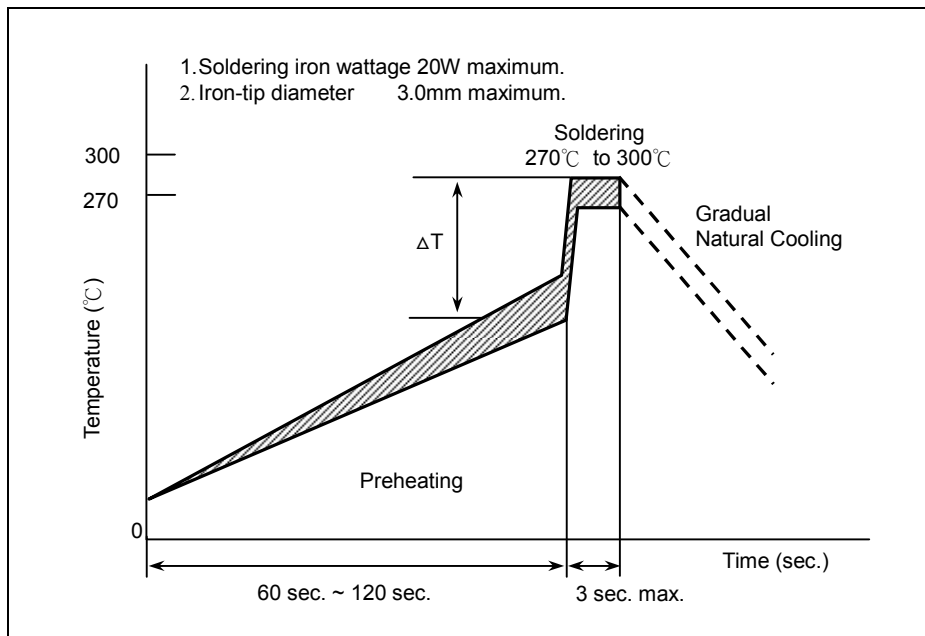

Chip Size	3216 and smaller	3225 and above
Preheating	$\Delta T \leq 190^\circ\text{C}$	$\Delta T \leq 130^\circ\text{C}$

[Soldering]

Reflow Soldering for Lead free Termination

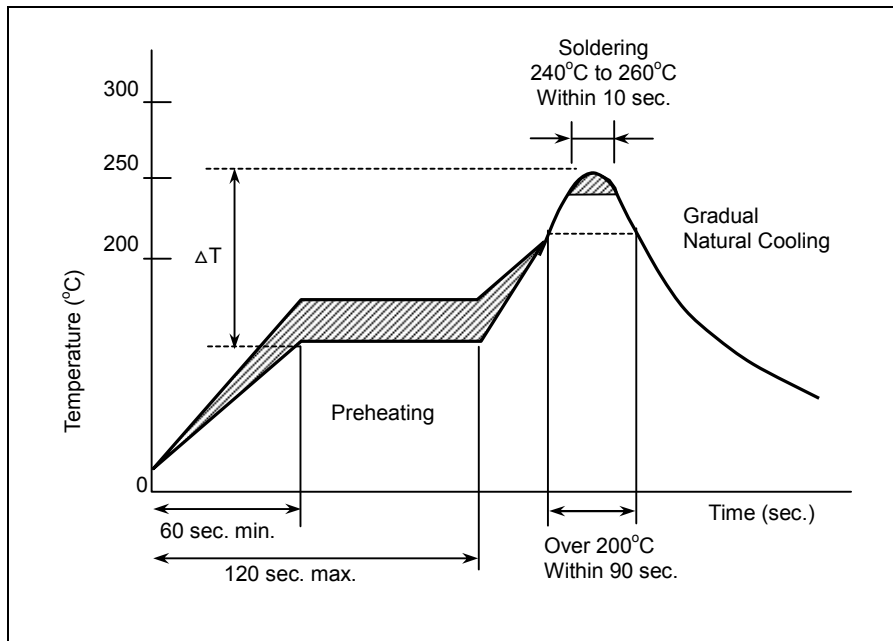

The difference between solder and chip surface should be controlled as following table. The rate of preheat should not exceed 4°C/sec and a target of 2°C/sec is preferred.

Chip Size	3216 and smaller	3225 and above
Preheating	$\Delta T \leq 150^\circ\text{C}$	$\Delta T \leq 130^\circ\text{C}$

Flow Soldering for Lead free Termination

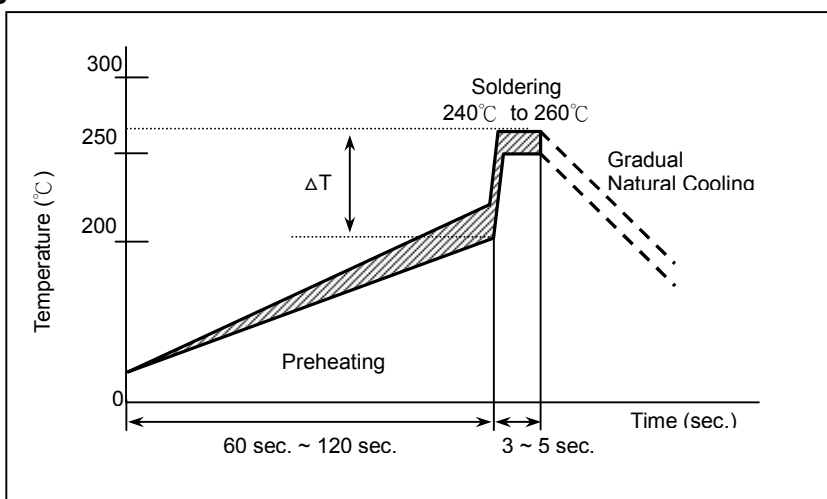

Chip Size	3216 and smaller	3225 and above
Preheating	$\Delta T \leq 150^\circ\text{C}$	-

MLCC

Soldering Iron

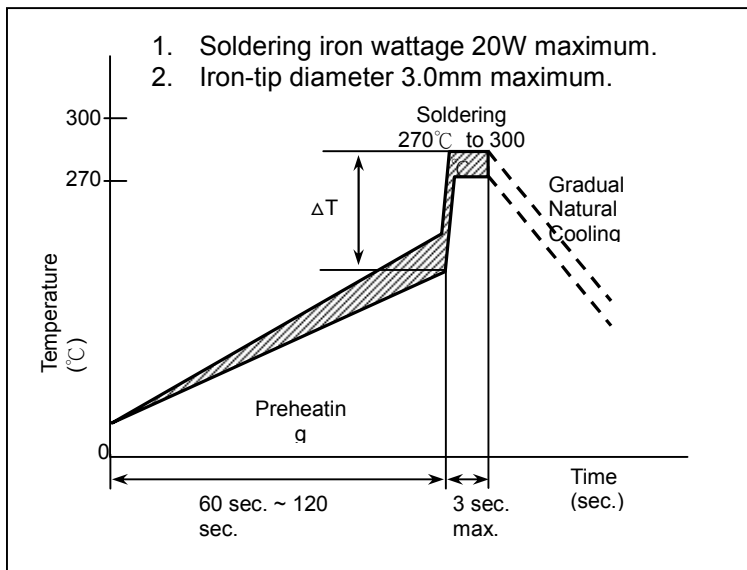

Chip Size	3216 and smaller	3225 and above
Preheating	$\Delta T \leq 190^{\circ}\text{C}$	$\Delta T \leq 130^{\circ}\text{C}$

【Chip Layout and Breaking PCB】

- To layout the SMD capacitors for reducing bend stress from board deflection of PCB. The following are examples of Hood and bad layout.

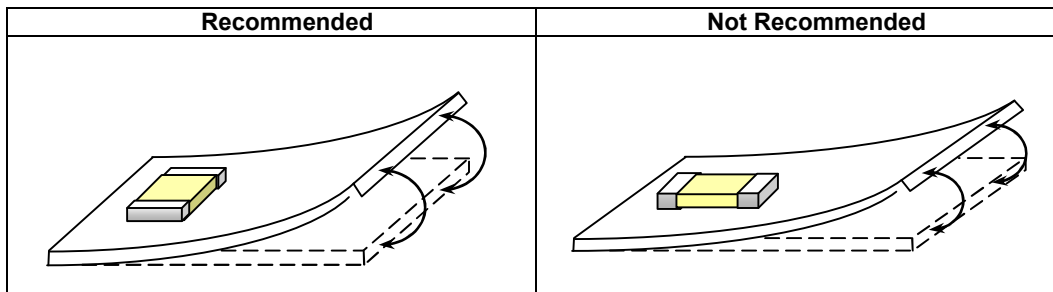

- When breaking PCB, the layout should be noted that the mechanical stresses are depending on the position of capacitors. The following example shows recommendation for better design.

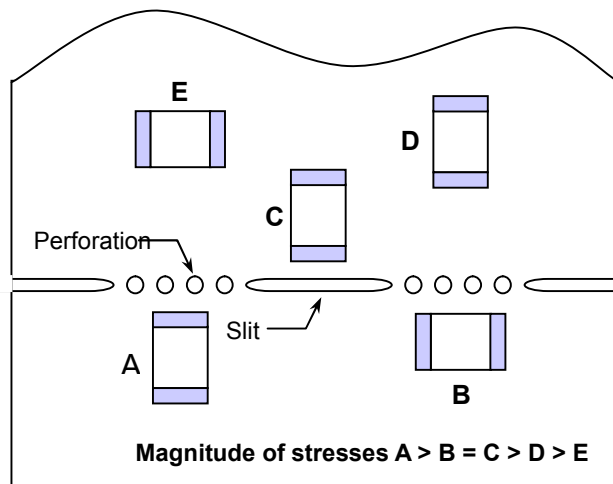

【Aging Rate】

The capacitance and dissipation factor of class 2 capacitors decreases with time. It is known as ‘aging’ that follows a logarithmic law and expressed in terms of an aging constant. Aging is caused by a gradual re-alignment of the crystalline structure of the ceramic. The aging constant is defined as the percentage loss of capacitance at a ‘time decade’. The law of capacitance aging is expressed as following equation:

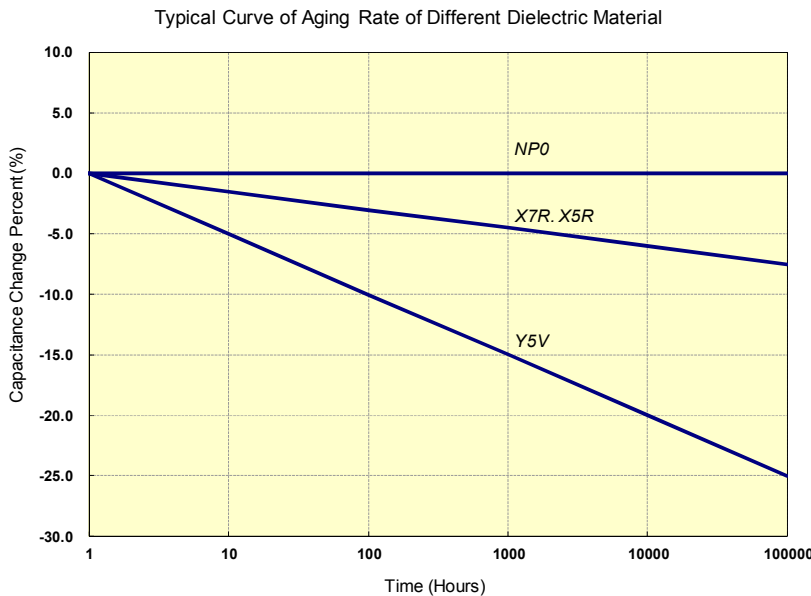

$$C_{t2} = C_{t1} \times (1 - k \times \log_{10}(t_2/t_1))$$

C_{t1} : Capacitance after t_1 hours of start aging.

C_{t2} : Capacitance after t_2 hours of start aging.

k : aging constant (capacitance decrease per decade)

t_1, t_2 : time in hours from start of aging.

A typical curve of aging rate is shown in following figure.

When heating the capacitors above Curie temperature ($130^{\circ}\text{C} \sim 150^{\circ}\text{C}$) the capacitance can be re-new. So capacitance of class 2 capacitors will be complete de-aged by soldering process; subsequently a new aging process begins.

Because of aging, it is specified an age for measurement to meet the prescribed tolerance for class 2 capacitors. Normally, 1000 hours ($t_2=1000$ hrs) is defined.

【Peeling Off Force】

Peeling off force: 0.1N to 1.0 N* in the direction shown as below.

The peeling speed: 300 ± 10 mm/min

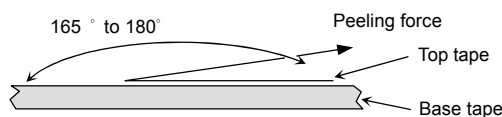

1. The taped tape on reel is wound clockwise. The sprocket holes are to the right as the tape is pulled toward the user.
2. There are minimum 150 mm as the leader and minimum 40 mm empty tape as the tail is attached to the end of the tape.