

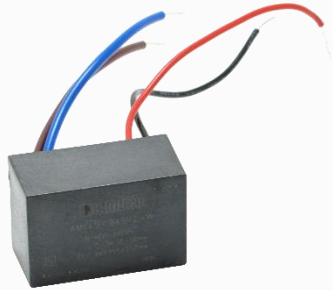

AMEL5-VZ



Encapsulated

The new AMEL5-VZ is a brand-new AC/DC converter that offers much greater cost effectiveness due to material normalization and production automation also leading to improved reliability and performance. Offering a commercial input voltage range of 85-264VAC and an output voltage range from 3.3-24V, this series will offer many benefits to your new system design.

This new series offers great operating temperatures, from -40°C to 70°C with full power up to 55°C. It also features an isolation of 4000VAC for improved reliability and system safety. Furthermore, a higher MTBF of 300,000h, output short circuit protection (OSCP), output over-current protection (OCP) and an output over-voltage protection (OVP) come standard with the series.

The AMEL5-VZ is perfect for street lighting controls, grid power, LED, instrumentation, industrial controls, communication and civil applications.

Features

- Universal Input: 85 - 264VAC/100 - 370VDC
- Operating Temp: -40 °C to +70 °C
- High isolation voltage: 4000VAC
- Low ripple & noise, 50mV(p-p), typ.
- Wire output terminal
- Output short circuit, over-current, over-voltage protection
- Regulated Output

Summary

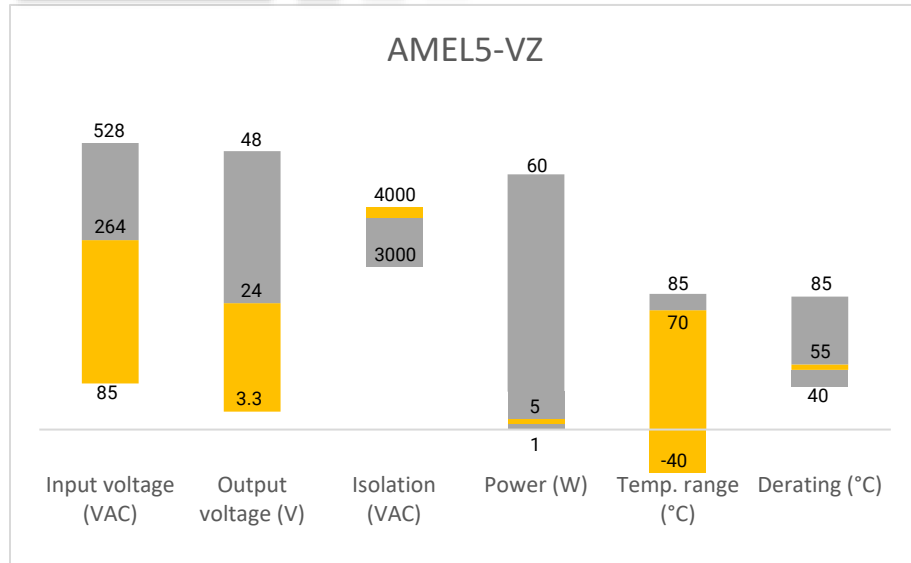

Training

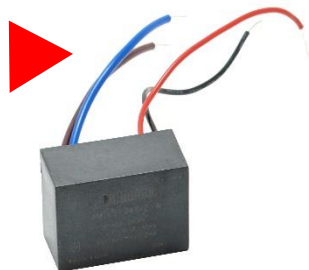

Product Training Video
(click to open)



Press Release

Coming Soon!

Application Notes

Applications



Power Grid



Industrial



Telecom



Instrumentation

Models & Specifications

Single Output

Model	Input Voltage (VAC/Hz)	Input Voltage (VDC)	Output Voltage (V)	Output Current max (A)	Maximum capacitive Load (μF)	Efficiency (%) 230VAC
AMEL5-3.3SVZ	85-264/47-63	100-370	3.3	1	5000	68
AMEL5-5SVZ	85-264/47-63	100-370	5	1	5000	75
AMEL5-9SVZ	85-264/47-63	100-370	9	0.56	1200	77
AMEL5-12SVZ	85-264/47-63	100-370	12	0.42	1200	79
AMEL5-15SVZ	85-264/47-63	100-370	15	0.33	1000	79
AMEL5-24SVZ	85-264/47-63	100-370	24	0.21	330	81

Note: Add suffix "ST" for chassis and suffix "STD" for DIN-Rail mounting (ex. AMEL5-5S277NZ-ST is chassis mounting and AMEL5-5S277NZ-STD is DIN-Rail mounting version).

Add suffix "-W" for optional wire terminal.

Input Specifications

Parameters	Conditions	Minimum	Typical	Maximum	Units
Current (full load)	115 VAC			130	mA
	230 VAC			70	mA
Inrush current <2ms (cold start)	115 VAC		10		A
	230 VAC		20		A
External fuse	Recommended slow blow type		1		A
Leakage Current	230VAC/50Hz			0.1	mA(rms)
Input Voltage	VAC	85		264	V
	VDC	100		370	V

Output Specifications

Parameters	Conditions	Typical	Maximum	Units
Voltage accuracy	3.3V output	±3		%
	Others	±2		%
Line regulation	Full Load	±0.5		%
Load regulation	0%-100% load	±1		%
Ripple & Noise*	20MHz Bandwidth, others	50	100	mV p-p
Hold-up time (minimum)	115VAC	23		ms
	230VAC	100		ms

* Ripple and Noise are measured at 20MHz bandwidth. Please refer to the application note for specific details.

Isolation Specifications

Parameters	Conditions	Typical	Rated	Units
Tested I/O voltage	60 sec	4000		VAC

General Specifications				
Parameters	Conditions	Typical	Maximum	Units
Switching frequency		100		KHz
Protection class	Class II			
Over Current protection	Auto recovery	≥120		% of I _{out}
Over voltage protection	3.3V / 5V Output, Zener diode clamp		≤ 7.5	VDC
	9V Output, Zener diode clamp		≤ 15	VDC
	12V / 15V Output, Zener diode clamp		≤ 20	VDC
	24V Output, Zener diode clamp		≤ 30	VDC
Short circuit protection	Continuous, hiccup, Auto recovery			
Operating temperature	See derating curve	-40 to +70		°C
Storage temperature		-40 to +105		°C
Temperature coefficient		±0.02		% / °C
Cooling	Free air convection			
Case material	Plastic (flammability to UL 94V-0)			
Weight	PCB mountable models	25		g
	With optional -ST mounting plate	47		g
	With optional -STD mounting plate	69		g
Dimensions (L x W x H)	PCB mountable models	1.46 x 0.96 x 0.71inch (37 x 24.5 x 18mm)		
	With optional -ST mounting plate	2.99 x 1.24 x 1.06inch (76 x 31 x 26.8mm)		
	With optional -STD mounting plate	2.99 x 1.24 x 1.24inch (76 x 31 x 31.4mm)		
MTBF	> 300,000 hrs (MIL-HDBK -217F, t=+25°C)/Full Load			
NOTE: All specifications in this datasheet are measured at an ambient temperature of 25°C, humidity<75%, nominal input voltage and at rated output load unless otherwise specified.				

Safety Specifications		
Parameters		
Agency approvals	cULus IEC/EN/UL 62368-1, IEC/EN/UL 60950-1	
Standards	EMI - Conducted and radiated emission	EN55032, class A EN55032, class B with EMC recommended circuit
	Electrostatic Discharge Immunity	IEC 61000-4-2, Contact: ±6KV/Air: ±8KV, Criteria B
	RF, Electromagnetic Field Immunity	IEC 61000-4-3, 10V/m, Criteria A
	Electrical Fast Transient/Burst Immunity	IEC 61000-4-4, ±2KV, Criteria B with typical application circuit IEC 61000-4-4, ±4KV, Criteria B with EMC recommended circuit
	Surge Immunity	IEC 61000-4-5, L-L ±1KV Criteria B with typical application circuit IEC 61000-4-5, L-L ±2KV/L-G ±4KV, Criteria B with EMC recommended circuit
	RF, Conducted Disturbance Immunity	IEC 61000-4-6, 10Vrms, Criteria A
	Voltage dips, Short Interruptions Immunity	IEC 61000-4-11, 0-70%, Criteria B

Derating

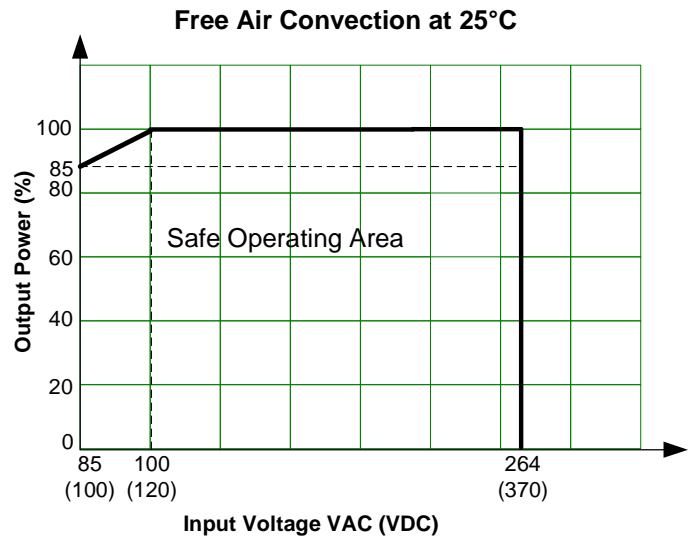
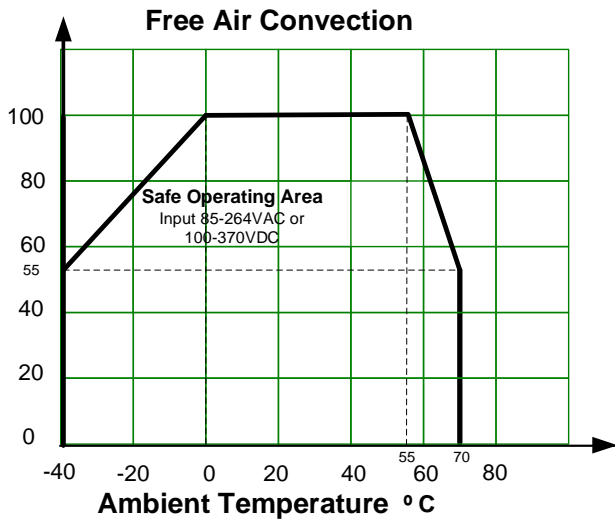

Typical Application Circuit

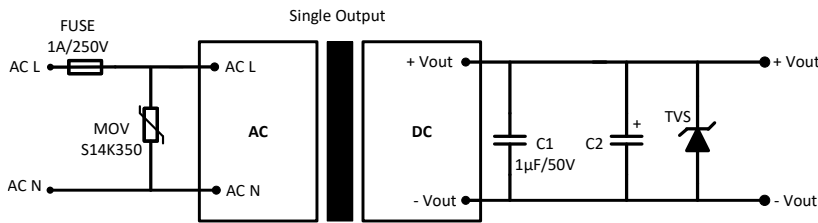

Pin Output Specifications		
Model	C2	TVS
3.3 & 5 Vout	150 µF / 35V	7V
9Vout	120 µF / 35V	12V
12 & 15 Vout	120 µF / 35V	20V
24 Vout	68 µF / 35V	30V

EMC recommended circuit

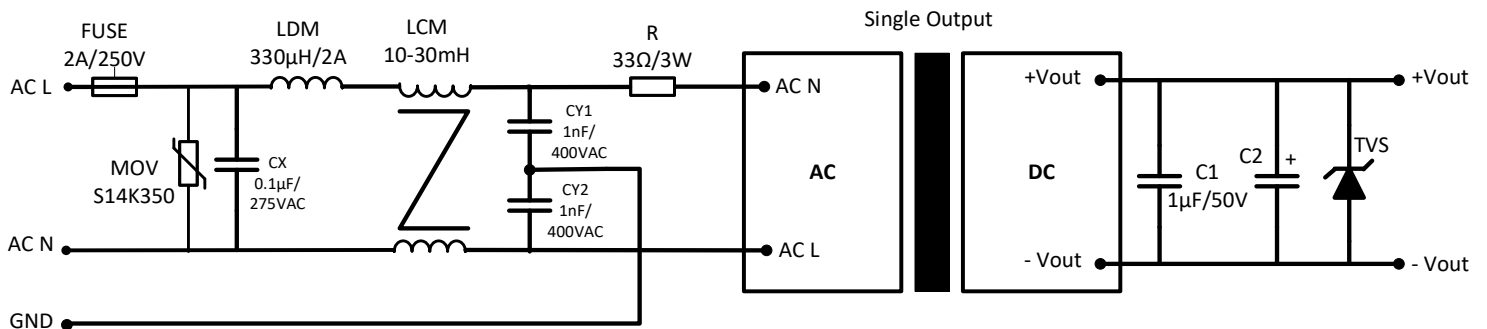

Model	C2	TVS
3.3 & 5 Vout	150 µF / 35V	7V
9Vout	120 µF / 35V	12V
12 & 15 Vout	120 µF / 35V	20V
24 Vout	68 µF / 35V	30V

Dimensions

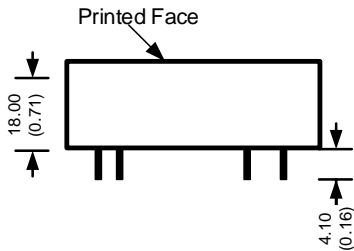
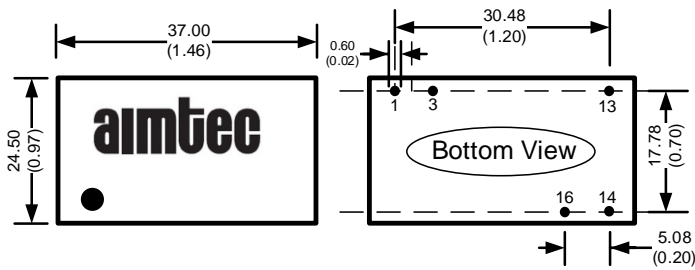

All dimensions are typical: millimeters (inches)
Pin Diameter: 0.60 ± 0.10 (0.02 ± 0.004)
Pin Pitch Tolerance: ± 0.35 (± 0.014)
Case Tolerance: ± 0.5 (± 0.02)

Pin Output Specifications	
Pin	Single
1	AC Input (L)
3	AC Input (N)
13	NC
14	-V Output
16	+V Output

Dimensions with -ST option

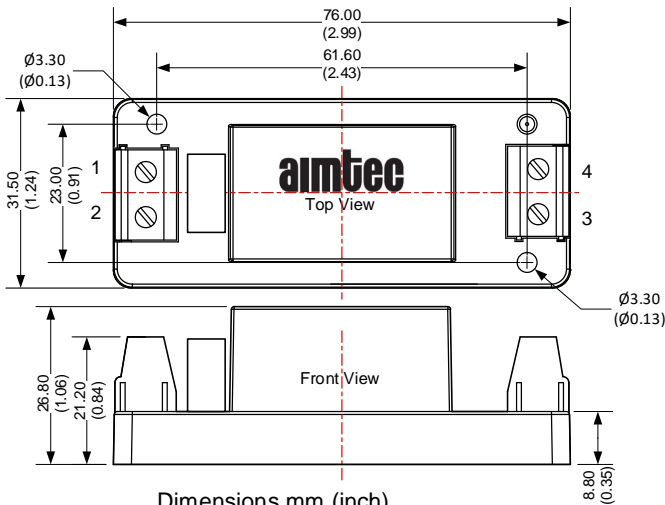

Dimensions mm (inch)
Wire range: 24-12 AWG
Tightening torque: 0.4Nm max.
General tolerances ± 0.50 (± 0.02)

Pin Output Specifications	
Pin	Function
1	-V Input (N)
2	+V Input (L)
3	-V Output
4	+V Output

Dimensions with -STD option

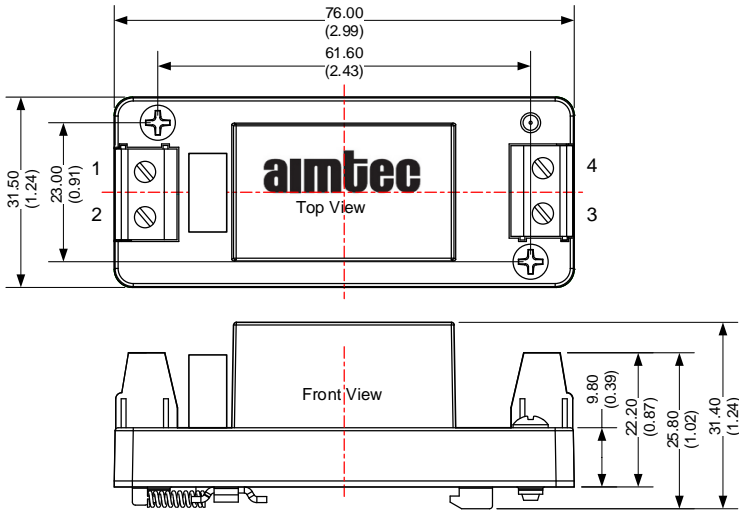

Dimensions mm (inch)
Wire range: 24-12 AWG
Tightening torque: 0.4Nm max.
General tolerances: ± 1.00 (± 0.04)
Mounting rail: Rail needs to connect safety ground.

Pin Output Specifications	
Pin	Function
1	-V Input (N)
2	+V Input (L)
3	-V Output
4	+V Output

Dimensions with -W option

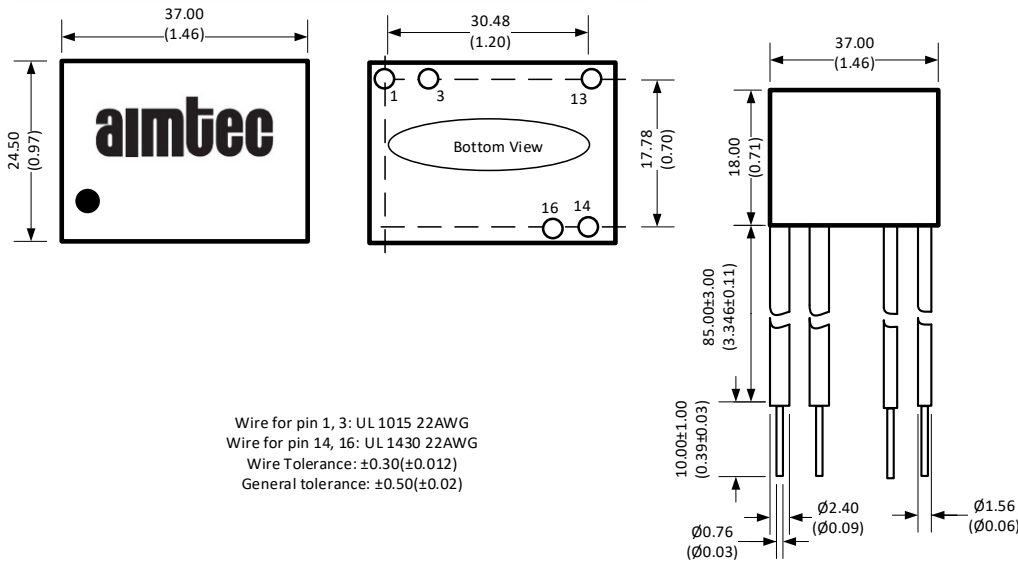

Wire for pin 1, 3: UL 1015 22AWG
Wire for pin 14, 16: UL 1430 22AWG
Wire Tolerance: ± 0.30 (± 0.012)
General tolerance: ± 0.50 (± 0.02)

Pin Output Specifications	
Pin	Single
1 brown	AC Input (L)
3 blue	AC Input (N)
13	NC
14 black	-V Output
16 red	+V Output

NOTE: 1. Datasheets are updated as needed and as such, specifications are subject to change without notice. Once printed or downloaded, datasheets are no longer controlled by Aimtec; refer to www.aimtec.com for the most current product specifications. 2. Product labels shown, including safety agency certifications on labels, may vary based on the date manufactured. 3. Mechanical drawings and specifications are for reference only. 4. All specifications are measured at an ambient temperature of 25°C, humidity < 75%, nominal input voltage and at rated output load unless otherwise specified. 5. Aimtec may not have conducted destructive testing or chemical analysis on all internal components and chemicals at the time of publishing this document. CAS numbers and other limited information are considered proprietary and may not be available for release. 6. This product is not designed for use in critical life support systems, equipment used in hazardous environments, nuclear control systems or other such applications which necessitate specific safety and regulatory standards other than the ones listed in this datasheet. 7. Warranty is in accordance with Aimtec's standard Terms of Sale available at www.aimtec.com.