

Mechanical Dimensions (mm)

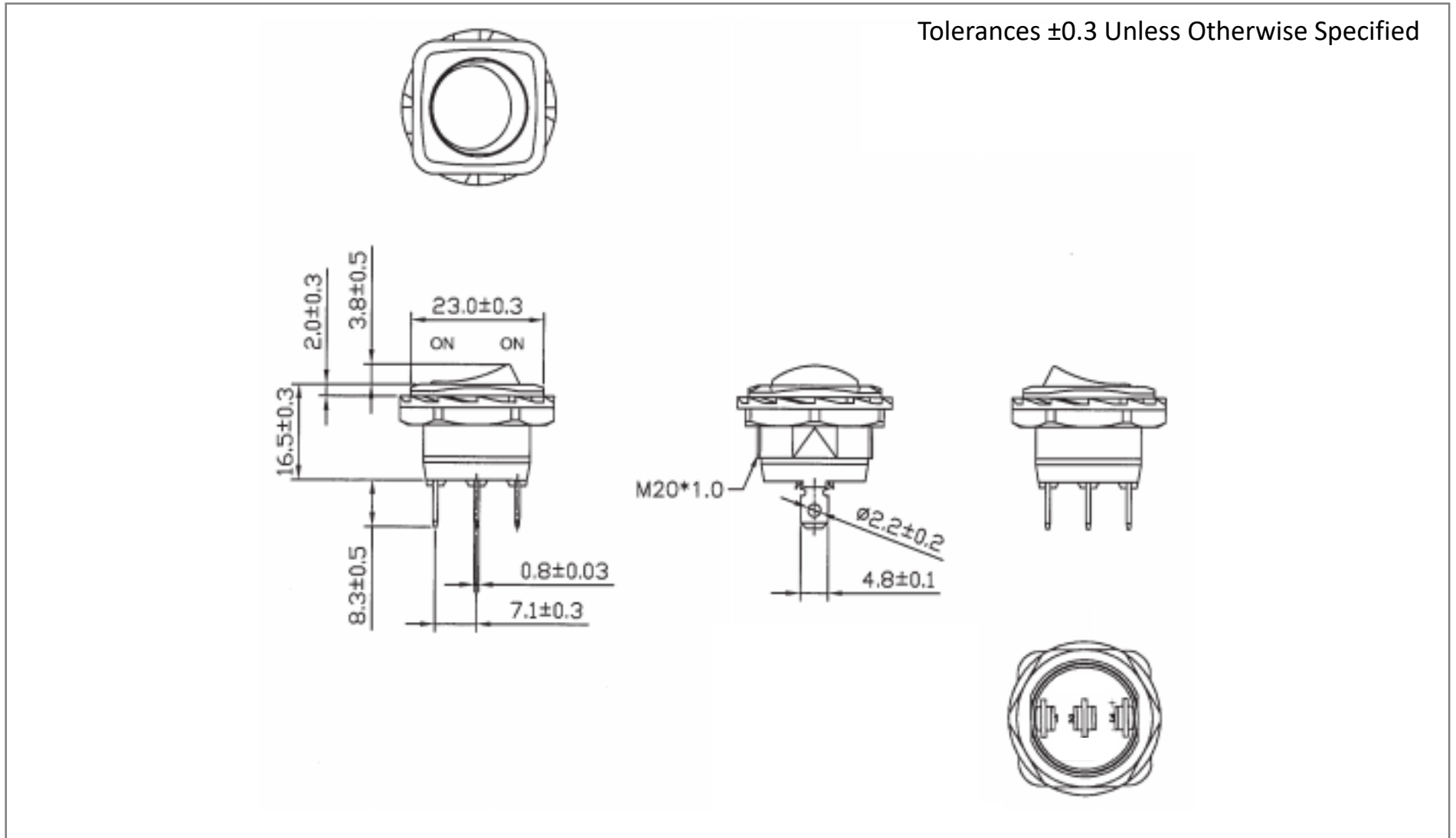

Mounting Hole

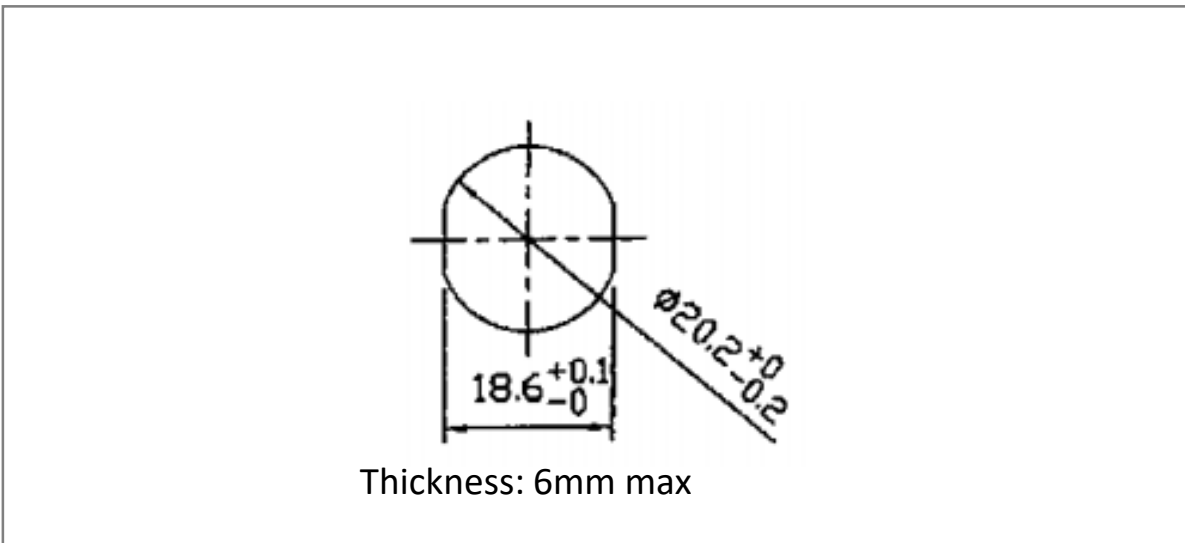

Circuit Diagram

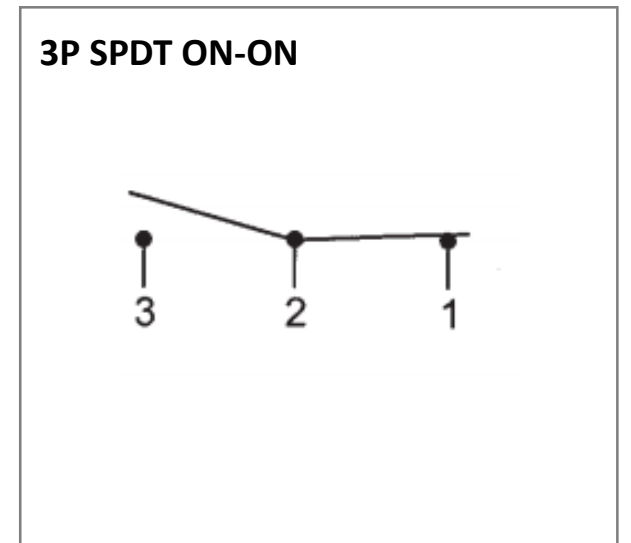

Electrical Specifications

Rating	20A 14V DC, 10A 28V DC
Contact Resistance	50m ohm Max.
Insulation Resistance	DC 500V 100M ohm Min.
Dielectric Strength	AC 1500V 1 minute
Operation Temperature	-25°C~85°C

Material Specifications

Frame	Black, Nylon 66+33%GF
Actuator	Black, Nylon 66