

Data Sheet

AS01208MS-SC12-WP-R

PUI Audio's **Mobile Series** line of speakers and receivers is designed for cutting-edge applications such as smart watches. The **AS01208MS-SC12-WP-R** is designed for submersion in water depths greater than 1 meter for 30 minutes when properly mounted. Front mounted double-sided tape, spring contacts, and a rear shock absorbing pad makes for easy integration.

**Features:**

- High output in one of the smallest form factors for a speaker
- Convenient double-sided tape on the face of the speaker
- Shock absorbing rear gasket for interference fitment

**Specifications**

Parameters	Values	Units
Rated Input Power	0.3	Watts
Max Input Power	0.5	Watts
Impedance	8 ± 15%	Ohms
Sensitivity (SPL @ 2kHz) 1.55V @ 10cm in 2cc enclosure	87.5±3	dB
Resonant Frequency (in 2cc enclosure)	1,300 ± 20%	Hz
Frequency Range (-10 dB)	800 ~ 20,000	Hz
Frame Material	PPA	-
Magnet Material	NdFeB	-
Weight	0.8	Grams
Ingress Protection Rating	IPX8	-
Buzz, Rattle, etc.	Should not be audible with 1.55V sine wave from 1.25 to 5 kHz	-
Polarity	When positive voltage is applied to the positive terminal, the diaphragm will move outward	-
Operating Temperature	-20 ~ +60	°C
Storage Temperature	-30 ~ +70	°C

## Measurement Method (measured with 1.55V, L = 10cm)

Standard test condition of speaker

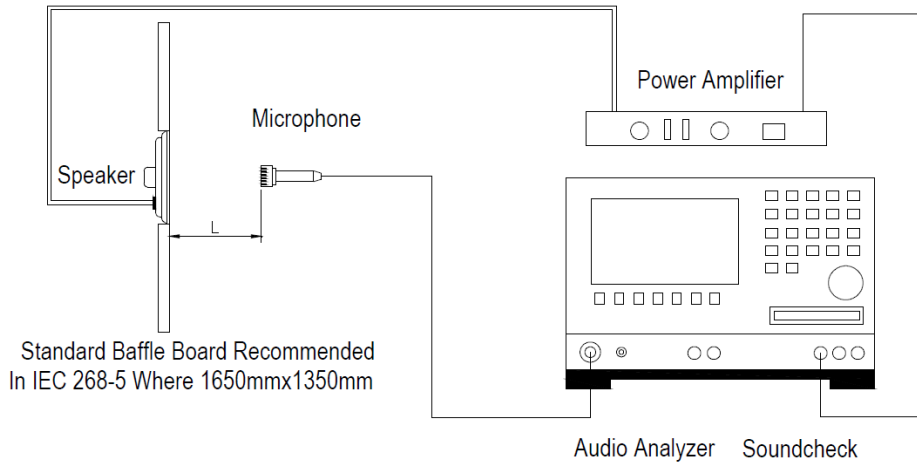

## Frequency Response (measured with 1.55V @ 10cm with speaker mounted in 2cc enclosure)

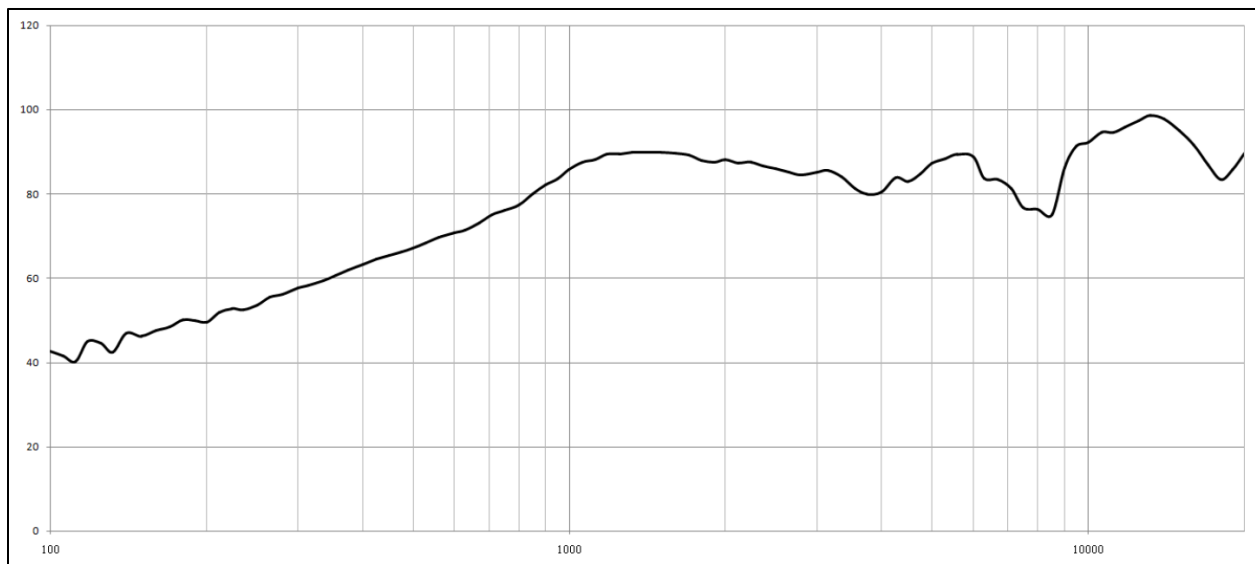

## Permitted Force on Spring Contacts (in Newton Meters)

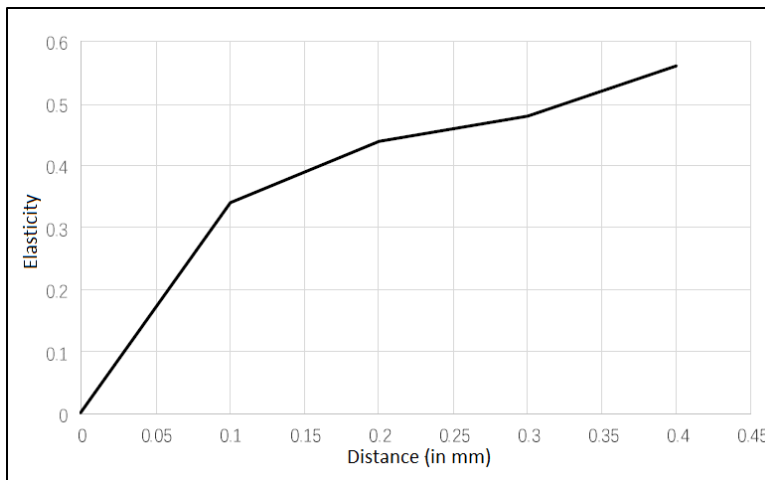

## Reliability Testing

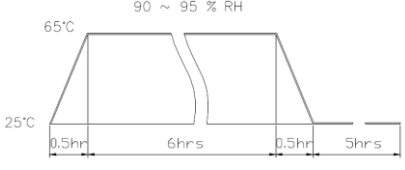
Type of Test	Test Specifications
High Temperature Test	96 hours at +60°C ± 3°C followed by three hours in normal room temperature
Low Temperature Test	96 hours at -20°C ± 3°C followed by three hours in normal room temperature
Humidity Test	96 hours at +30°C ± 3°C with relative humidity between 92% and 95% followed by 3 hours in normal room temperature
Temperature Cycle Testing	The part shall be subjected to 5 cycles using the following procedure: 
Vibration Test	10 to 55 to 10 Hz sine sweep with 1.5mm amplitude 2 hours in each axis X, Y, and Z.
Drop Test	Drop the speakers onto a 40mm thick board 10 times from a height of 75cm
Load Test and Max Power Test	White noise is applied at the speakers rated power for 96 hours at room temperature.

After each test, the speaker's SPL shall be ±3 dB of the original SPL

## Dimensions

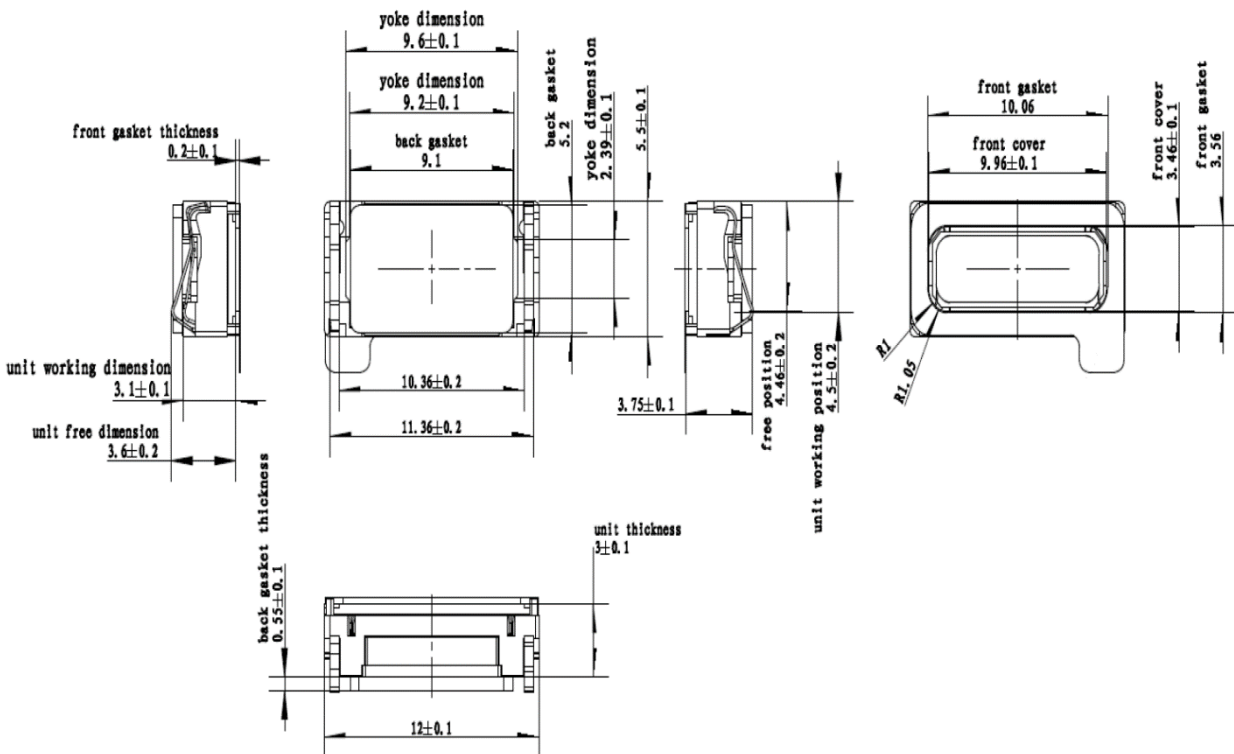

## Packaging

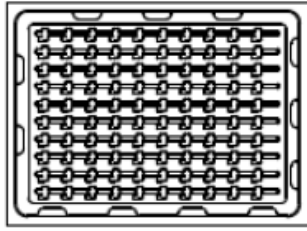

Tray  
340\*245\*16【mm】  
Qts=100pcs

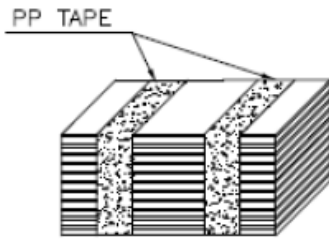

340\*245\*190【mm】  
Qts:100\*15=1500pcs

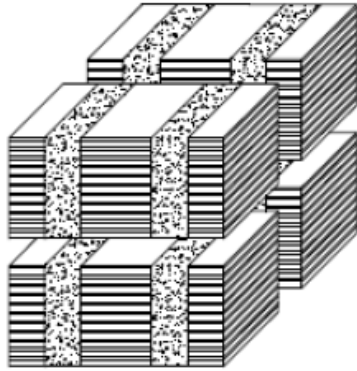

CARTON BOX  
(PAPER:DW-1,3T)  
515\*360\*380【mm】  
Qts:1500\*4=6000pcs

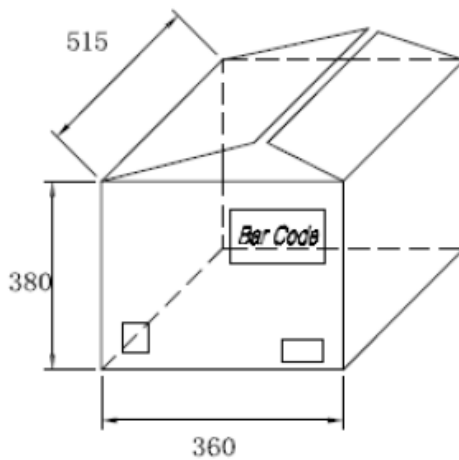

**Specifications Revisions**

<b>Revision</b>	<b>Description</b>	<b>Date</b>
-	Released from Engineering	7/15/2019
A	Resonant Frequency Changed to 1300 Hz	8/7/2019

Note:

1. Unless otherwise specified:
  - A. All dimensions are in millimeters.
  - B. Default tolerances are  $\pm 0.5\text{mm}$  and angles are  $\pm 3^\circ$ .
2. Specifications subject to change or withdrawal without notice.
3. This part is RoHS 2011/65/EU Compliant.