

Data sheet | Item number: 2616-1101

PCB terminal block; lever; 16 mm<sup>2</sup>; Pin spacing 10 mm; 1-pole; Push-in CAGE CLAMP®; 16,00 mm<sup>2</sup>; gray

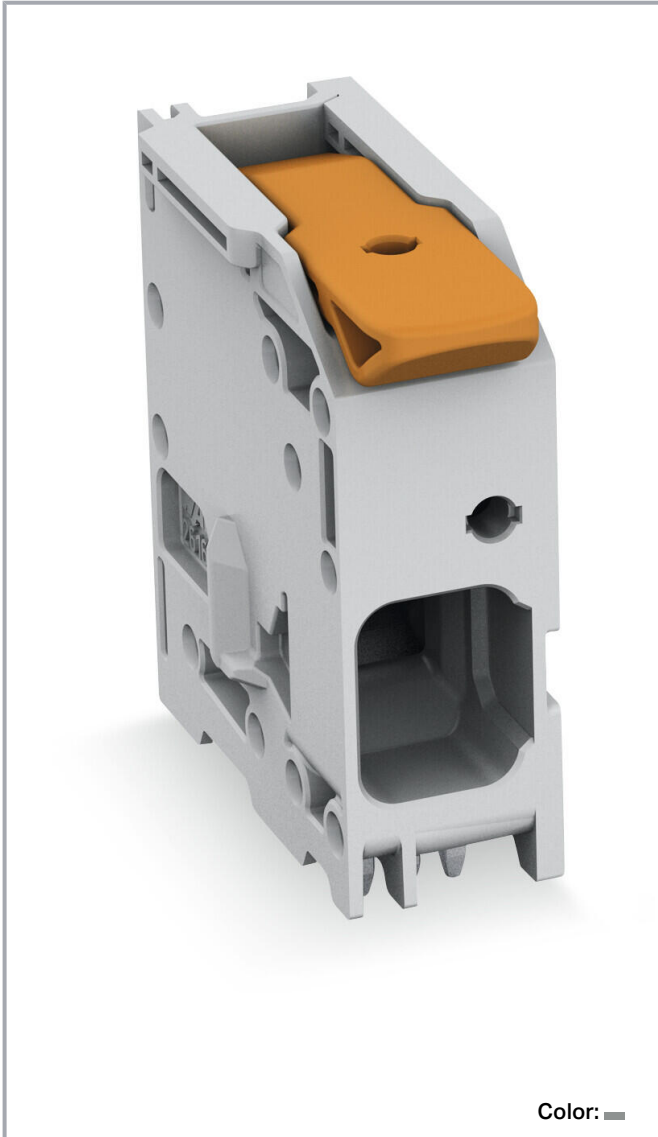

[www.wago.com/2616-1101](http://www.wago.com/2616-1101)



Color: ■

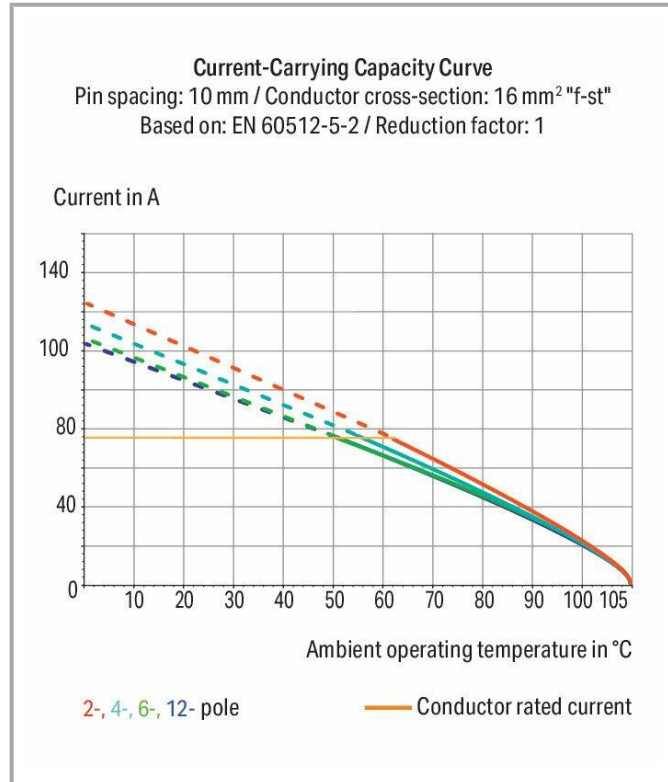

Subject to changes. Please also observe the further product documentation!

WAGO GmbH & Co. KG  
Hansastr. 27  
32423 Minden  
Phone: +49571 887-0 | Fax: +49571 887-169  
Email: [info.de@wago.com](mailto:info.de@wago.com) | Web: [www.wago.com](http://www.wago.com)

Do you have any questions about our products?  
We are always happy to take your call at +49 (571) 887-44222.

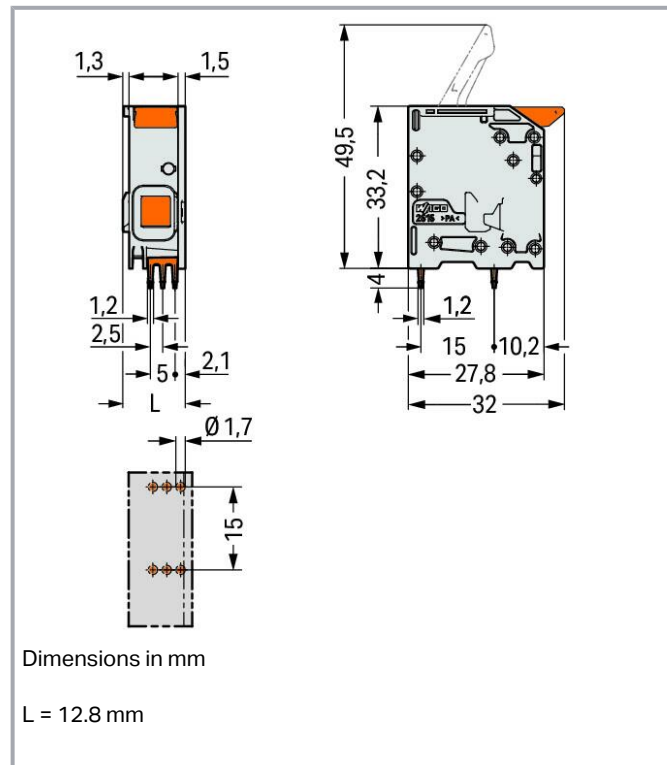
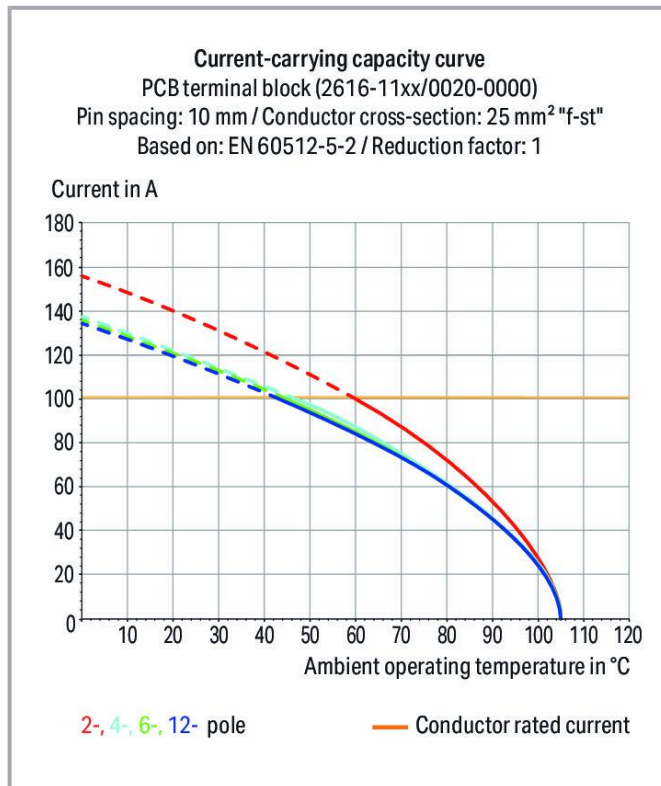

## Item description

- PCB terminal blocks with lever-actuated Push-in CAGE CLAMP® connection
- Push-in termination of solid and ferruled conductors
- Intuitive and tool-free operation
- Several clamping units can be held open simultaneously – convenient for terminating multi-core cables
- Testing can be performed both parallel and perpendicular to conductor entry

## Data

### Notes

Note	The inherent stability of a single-pole PCB terminal block is less than that of a multi-pole terminal strip. The customer must therefore ensure that these terminal blocks are protected against excessive mechanical stress (e.g., torsional or bending stress), both when connecting the conductor and during subsequent use, for example by providing additional support, shortly holding the connected conductor and appropriate actuation instructions.
------	--

Variants:	Other pole numbers Direct marking
-----------	--------------------------------------

Subject to changes. Please also observe the further product documentation!



Other colors

Other versions (or variants) can be requested from WAGO Sales or configured at <https://configurator.wago.com/>.

## Electrical data

### Ratings per IEC/EN

Ratings per	IEC/EN 60664-1
Nominal voltage (III/3)	1000 V
Rated impulse voltage (III/3)	8 kV
Rated voltage (III/2)	1000 V
Rated impulse voltage (III/2)	8 kV
Nominal voltage (II/2)	1000 V
Rated surge voltage (II/2)	8 kV
Rated current	76 A
Legend (ratings)	(III / 2) $\hat{=}$ Overvoltage category III / Pollution degree 2

### Ratings per UL 1059

Approvals per	UL 1059
Rated voltage UL (Use Group B)	600 V
Rated current UL (Use Group B)	78 A
Rated voltage UL (Use Group C)	600 V
Rated current UL (Use Group C)	78 A

### Ratings per CSA

Approvals per	CSA
Rated voltage CSA (Use Group B)	600 V
Rated current CSA (Use Group B)	72 A
Rated voltage CSA (Use Group C)	1000 V
Rated current CSA (Use Group C)	72 A

## Connection data

Connection points	1
Total number of potentials	1
Number of connection types	1
Number of levels	1

Subject to changes. Please also observe the further product documentation!

WAGO GmbH & Co. KG  
 Hansastr. 27  
 32423 Minden  
 Phone: +49571 887-0 | Fax: +49571 887-169  
 Email: [info.de@wago.com](mailto:info.de@wago.com) | Web: [www.wago.com](http://www.wago.com)

Do you have any questions about our products?  
 We are always happy to take your call at +49 (571) 887-44222.



## Connection 1

Connection technology	Push-in CAGE CLAMP®
Actuation type	Lever
Solid conductor	0.75 ... 16 mm <sup>2</sup> / 18 ... 4 AWG
Fine-stranded conductor	0.75 ... 25 mm <sup>2</sup> / 18 ... 4 AWG
Fine-stranded conductor; with insulated ferrule	0.75 ... 16 mm <sup>2</sup>
Fine-stranded conductor; with uninsulated ferrule	0.75 ... 16 mm <sup>2</sup>
Fine-stranded conductor; with twin ferrule	0.75 ... 6 mm <sup>2</sup>
Strip length	18 ... 20 mm / 0.71 ... 0.79 inches
Conductor connection direction to PCB	0°
Pole number	1

## Physical data

Pin spacing	10 mm / 0.394 inches
Width	12.8 mm / 0.504 inches
Height	37.2 mm / 1.465 inches
Height from the surface	33.2 mm / 1.307 inches
Depth	32 mm / 1.26 inches
Solder pin length	4 mm
Solder pin dimensions	1.2 x 1.2 mm
Drilled hole diameter with tolerance	1.7 <sup>(+0.1)</sup> mm

## PCB contact

PCB contact	THT
Solder pin arrangement	Over the entire terminal strip (in-line)
Number of solder pins per potential	6

## Material Data

Note (material data)	Information on material specifications can be found here
Color	gray
Material group	I
Insulation material	Polyamide (PA66)
Flammability class per UL94	V0
Clamping spring material	Chrome-nickel spring steel (CrNi)

Subject to changes. Please also observe the further product documentation!

Contact material	Electrolytic copper (E <sub>Cu</sub> )
Contact plating	Tin
Fire load	0.147 MJ
Actuator color	orange
Weight	10.8 g

### Environmental requirements

Limit temperature range	-60 ... +105 °C
Processing temperature	-35 ... +60 °C

### Commercial data



eCl@ss 10.0	27-44-04-01
eCl@ss 9.0	27-44-04-01
ETIM 8.0	EC002643
ETIM 7.0	EC002643
PU (SPU)	100 pcs
Packaging type	box
Country of origin	PL
GTIN	4055143692762
Customs tariff number	85369010000

### Environmental Product Compliance

RoHS Compliance Status	Compliant, No Exemption
------------------------	-------------------------

### Approvals / Certificates

#### General approvals







Logo	Approval	Additional Approval Text	Certificate name
	CSA DEKRA Certification B.V.	C22.2	70154737
	cURus Underwriters Laboratories Inc.	C22.2 No. 158	E45172
	KEMA/KEUR DEKRA Certification B.V.	EN 60947-7-4	71- 110774

Subject to changes. Please also observe the further product documentation!



## Optional accessories

### Ferrule

Ferrule	
	<b>Item no.: 216-210</b> Ferrule; Sleeve for 16 mm <sup>2</sup> / AWG 6; insulated; electro-tin plated; electrolytic copper; gastight crimped; acc. to DIN 46228, Part 4/09.90; blue <a href="http://www.wago.com/216-210">www.wago.com/216-210</a>
	<b>Item no.: 216-284</b> Ferrule; Sleeve for 1.5 mm <sup>2</sup> / AWG 16; insulated; electro-tin plated; electrolytic copper; gastight crimped; acc. to DIN 46228, Part 4/09.90; black <a href="http://www.wago.com/216-284">www.wago.com/216-284</a>
	<b>Item no.: 216-286</b> Ferrule; Sleeve for 2.5 mm <sup>2</sup> / AWG 14; insulated; electro-tin plated; electrolytic copper; gastight crimped; acc. to DIN 46228, Part 4/09.90; blue <a href="http://www.wago.com/216-286">www.wago.com/216-286</a>
	<b>Item no.: 216-287</b> Ferrule; Sleeve for 4 mm <sup>2</sup> / AWG 12; insulated; electro-tin plated; electrolytic copper; gastight crimped; acc. to DIN 46228, Part 4/09.90; gray <a href="http://www.wago.com/216-287">www.wago.com/216-287</a>
	<b>Item no.: 216-288</b> Ferrule; Sleeve for 6 mm <sup>2</sup> / AWG 10; insulated; electro-tin plated; electrolytic copper; gastight crimped; acc. to DIN 46228, Part 4/09.90; yellow <a href="http://www.wago.com/216-288">www.wago.com/216-288</a>
	<b>Item no.: 216-289</b> Ferrule; Sleeve for 10 mm <sup>2</sup> / AWG 8; insulated; electro-tin plated; electrolytic copper; gastight crimped; acc. to DIN 46228, Part 4/09.90; red <a href="http://www.wago.com/216-289">www.wago.com/216-289</a>

## Downloads

### Documentation

#### Additional Information

Technical Section	2019 Apr 3	pdf	Download
Technical explanations		2.0 MB	

## CAD/CAE-Data

### CAD data

2D/3D Models 2616-1101	URL	Download
------------------------	-----	----------

### PCB Design

Symbol and Footprint 2616-1101	URL	Download
--------------------------------	-----	----------

Subject to changes. Please also observe the further product documentation!

WAGO GmbH & Co. KG  
 Hansastr. 27  
 32423 Minden  
 Phone: +49571 887-0 | Fax: +49571 887-169  
 Email: [info.de@wago.com](mailto:info.de@wago.com) | Web: [www.wago.com](http://www.wago.com)

Do you have any questions about our products?  
 We are always happy to take your call at +49 (571) 887-44222.



CAX data for your PCB design, consisting of "schematic symbols and PCB footprints", allow easy integration of the WAGO component into your development environment.

**Supported formats:**

- Accel EDA 14 & 15
- Altium 6 to current version
- Cadence Allegro
- DesignSpark
- Eagle Libraries
- KiCad
- Mentor Graphics BoardStation
- Mentor Graphics Design Architect
- Mentor Graphics Design Expedition 99 and 2000
- OrCAD 9.X PCB and Capture
- PADS PowerPCB 3, 3.5, 4.X, and 5.X
- PADS PowerPCB and PowerLogic 3.0
- PCAD 2000, 2001, 2002, 2004, and 2006
- Pulsonix 8.5 or newer
- STL
- 3D STEP
- TARGET 3001!
- View Logic ViewDraw
- Quadcept
- Zuken CadStar 3 and 4
- Zuken CR-5000 and CR-8000

PCB Component Libraries (EDA), PCB CAD Library Ultra Librarian

---

**CAE data**

ZUKEN Portal 2616-1101	<a href="#">URL</a>	<a href="#">Download</a>
------------------------	---------------------	--------------------------

---

**Environmental Product Compliance**

**Compliance Search**

Environmental Product Compliance 2616-1101 PCB terminal block; lever; 16 mm <sup>2</sup> ; Pin spacing 10 mm; 1-pole; Push-in CAGE CLAMP®; 16,00 mm <sup>2</sup> ; gray	<a href="#">URL</a>	<a href="#">Download</a>
--	---------------------	--------------------------

---

Subject to changes. Please also observe the further product documentation!

---

WAGO GmbH & Co. KG  
Hansastr. 27  
32423 Minden  
Phone: +49571 887-0 | Fax: +49571 887-169  
Email: [info.de@wago.com](mailto:info.de@wago.com) | Web: [www.wago.com](http://www.wago.com)

Do you have any questions about our products?  
We are always happy to take your call at +49 (571) 887-44222.

## Installation Notes

### Conductor termination

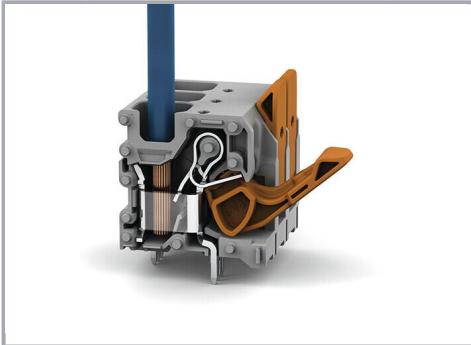

Insert fine-stranded conductors – and remove all conductors – via operating tool.

### Conductor termination

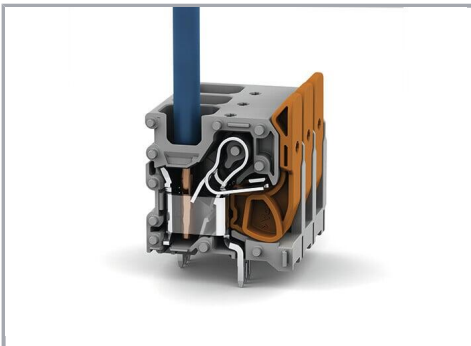

Insert solid conductors via push-in termination.

Subject to changes. Please also observe the further product documentation!