



MECHANICAL SPECIFICATIONS

- Mechanical rotation angle: $310^\circ \pm 5^\circ$
- Electrical rotation angle: $290^\circ \pm 20^\circ$
- Torque: 0.5 to 1.5 Ncm. (0.7 to 2.1 in-oz)
- Stop torque: > 80 Ncm. (> 112 in-oz)

* Others upon request.

** Up to 85°C depending on application.

FEATURES

- Carbon resistive element.
- High mechanical endurance.
- Upon request:
 - Detents.
 - Stereo matching.
 - Switch.
 - Nut & washer.
 - Custom assemblies with wires and connectors.

ELECTRICAL SPECIFICATIONS

- Range of values*
 $100\Omega \leq R_n \leq 5\text{ M}$ (Decad. 1.0 - 2.0 - 2.2 - 2.5 - 4.7 - 5.0)
- Standard tolerance*: $100\Omega \leq R_n \leq 1\text{ M}$ $\pm 20\%$
 $1\text{ M}\Omega < R_n \leq 5\text{ M}$ $\pm 30\%$
- Max. Voltage: 250 VDC (lin) 150 VDC (no lin)
- Nominal Power 50°C (122°F) (see power rating curve)
0.25 W (lin) 0.12 W (no lin)
- Taper* (Log. & Alog. only $R_n > 1\text{ K}$) Lin ; Log; Alog.
- Residual resistance*: $\leq 0.5\% R_n$ (5 Ω min)
- Equivalent Noise Resistance: $\leq 3\% R_n$ (3 Ω min.)
- Operating temperature**: $-25^\circ\text{C} + 70^\circ\text{C}$ ($-13^\circ\text{F} + 158^\circ\text{F}$)

HOW TO ORDER

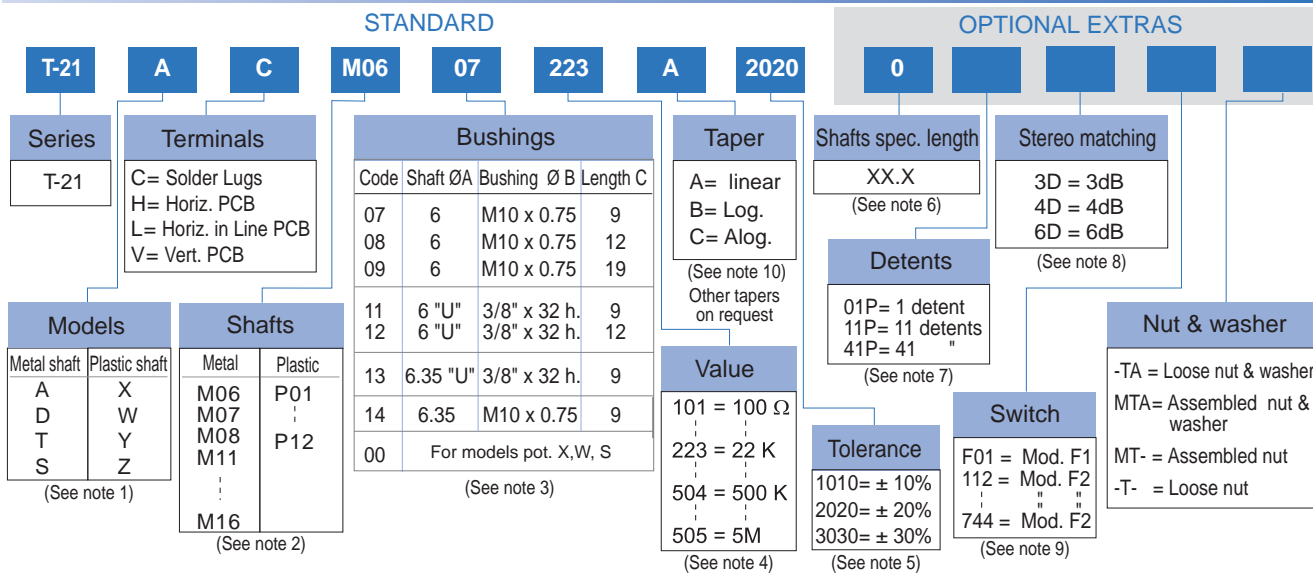

NOTES:

- MODELS: Models D y T are not available with "V" terminals.
- SHAFTS: The codes indicate diameter and length. M08: Code for the double potentiometer.
- BUSHINGS: The codes types 11, 12 and 13 have an antirotation lug (at 90°CW). Plastic shaft and double model are only available with Ø6 bushing.
- VALUE:
 - Code: $\frac{10}{1} = 100\Omega$
 - Number of zeros
 - 2 first digits of the value.
 - In models "D" and "T" with different values, order under special drawing number.
- Tolerance (special), upon request. Example: +7% Code: 07, -5% Code: 05
- Shafts special length:
 - Only for special length and plain shafts (not knurled). Example: Shaft Ø6 L= 24.5
 - Flatted and slotted shafts, etc. will need drawing.
 - Shaft M08 (T-21D) with other length, order under special drawing number. Recommendation: Shaft L > 60 bushing C = 19
- DETENTS: - Not available in models with plastic shaft X, W, Y, Z. - Detents and switch are not compatible.
- Stereo matching: Only available in tandem models and upon request.
- SWITCHES: Two types of switches are offered: F1 and F2.
 - F1 = The code is "F01"
 - Plastic shafts are only available if they are code P10, P11 or P12
 - F2 = (Only with metal shaft) Indicate the corresponding I-21 switch code.
- Switch option not available with antilog taper.

HOW TO ORDER CUSTOM DRAWING

T-21 A C + DRAWING NUMBER (Max. 16 digits)

This way of ordering should be used for options which are not included in the "How to order" standard and optional extras.

STANDARD OPTIONS

Shaft length 0 standard
 Detents Without
 Stereo matching Only for model "T" and upon request
 Switch No switch
 Nut & washer Without nut and washer

MODELS WITH METALIC SHAFTS

T-21 A

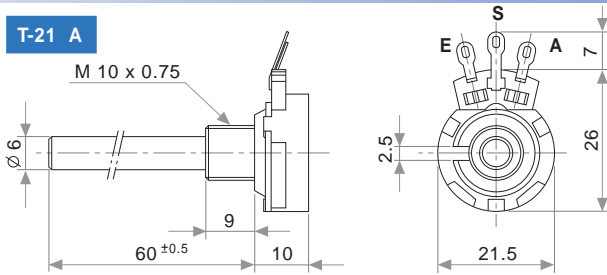

T-21 T

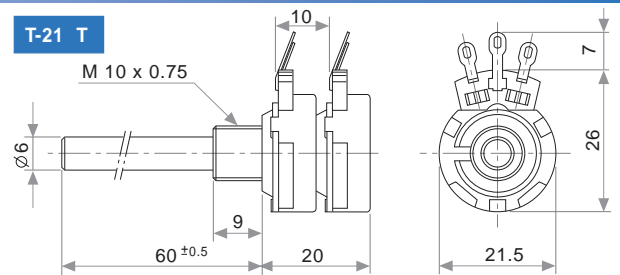

A = Initial
 S = Wiper
 E = Final

T-21 D

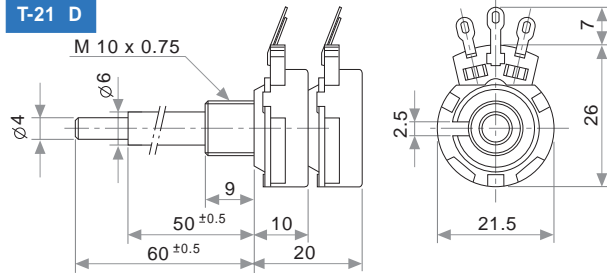

T-21 S

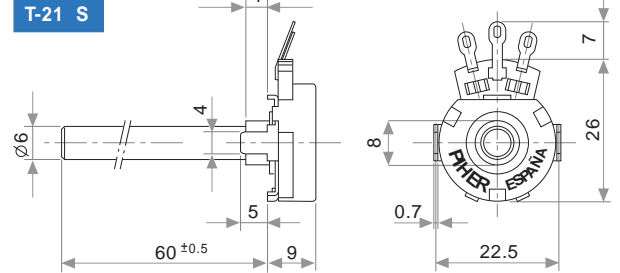

MODELS WITH PLASTIC SHAFTS

T-21 X

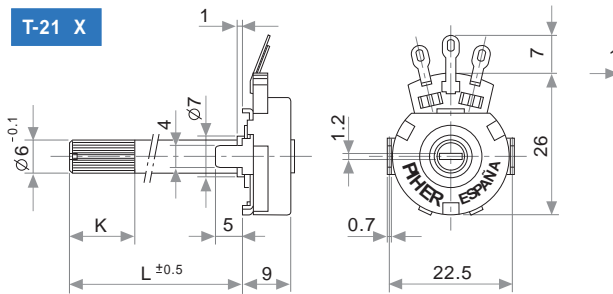

T-21 W

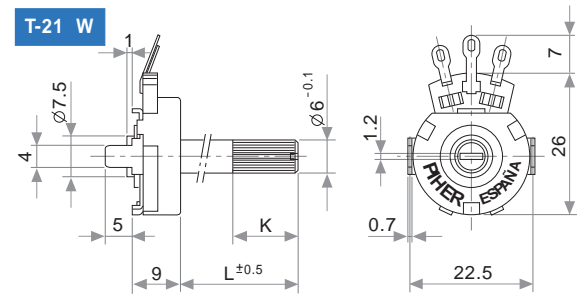

T-21 Y

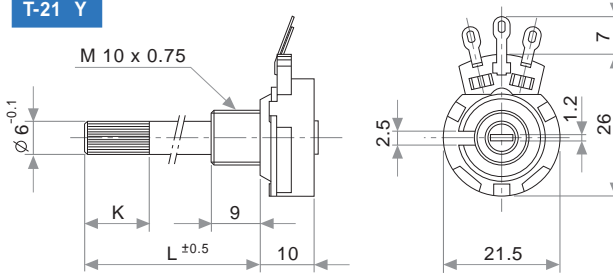

T-21 Z

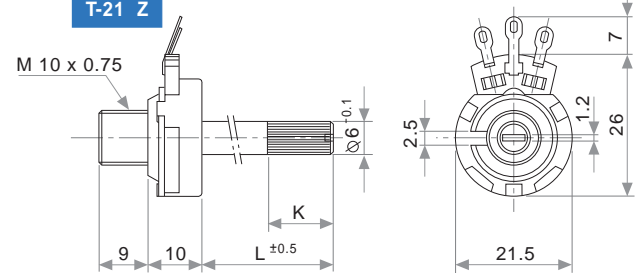

TERMINALS

T-21 C

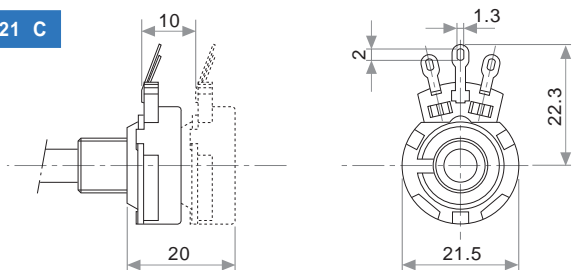

T-21 H

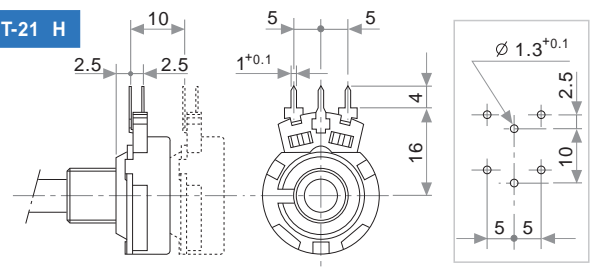

T-21 L

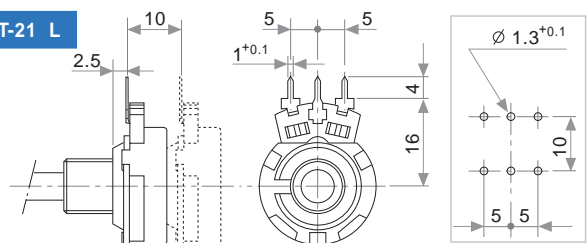

T-21 V

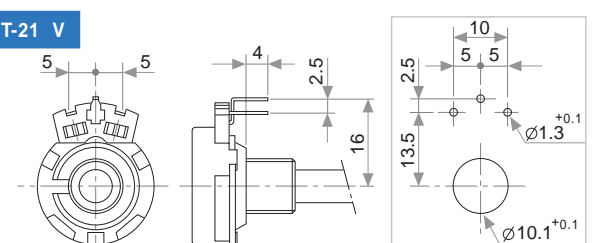

PLASTIC SHAFTS

T-21 X/Y without Switch			
Knurling length	T-21 X	T-21 Y	CODE
K = 0	L = 2	/	P01
K = 6	L = 10	/	P02
K = 12	L = 16	L = 15	P03
K = 12	L = 26	L = 25	P04
K = 12	L = 36	L = 35	P05
K = 35	L = 46	L = 45	P06

T-21Y w/Sw F01		
Knurling length	T-21 Y	CODE
K = 5	L = 16	P10
K = 14.6	L = 25	P11
K = 35	L = 46	P12

T-21 W/Z without Switch			
Knurling length	T-21 W	T-21 Z	CODE
K = 12	L = 26	L = 26	P07
K = 12	L = 36	L = 36	P08
K = 12	L = 46	L = 46	P09

METALIC SHAFTS

PLAIN SHAFT

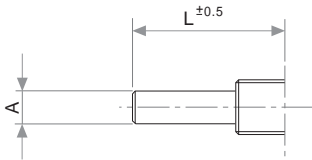

A	L	CODE
4	40	M04
6	60	M06
6.35	60	M07
4/6	50/60	M08

KNURLED SHAFT

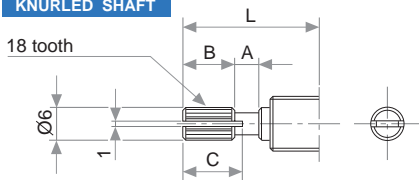

L	A	B	C	CODE
15	2	6	7	M11
20	2	10	11	M12
25	4	12	14	M13
30	4	12	14	M14
35	4	12	14	M15
40	4	12	14	M16

UNDER DRAWING

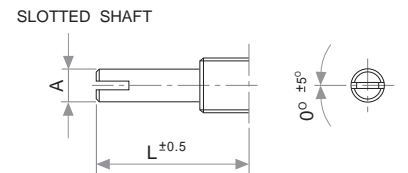
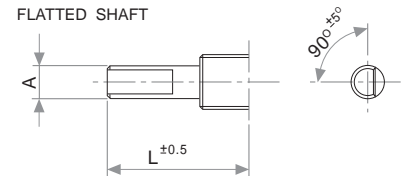

BUSHINGS

STANDARD

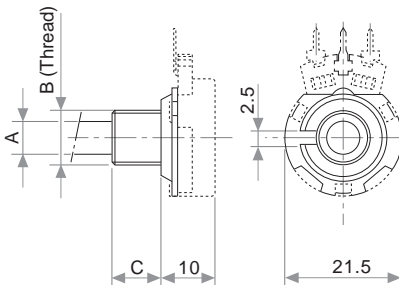

CODE	A	B	C
07	6	M10 x 0.75	9
08	6	M10 x 0.75	12
09	6	M10 x 0.75	19
14	6.35	M10 x 0.75	9

NON ROTARY PAWL

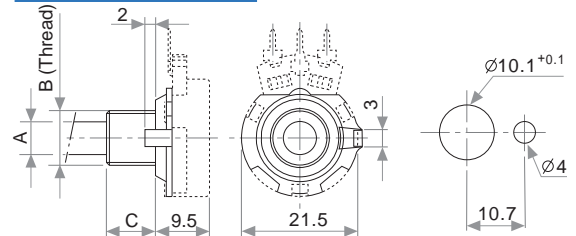

CODE	A	B	C
11	6	3/8" x 32 h.	9
12	6	3/8" x 32 h.	12
13	6.35	3/8" x 32 h.	9

DETENTS

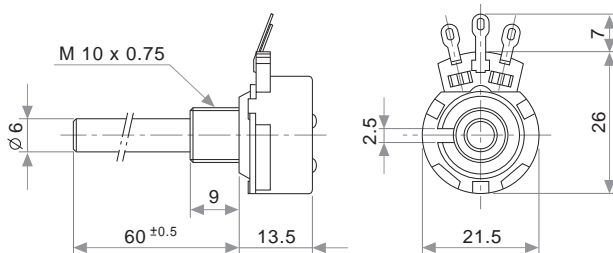

TAPERS

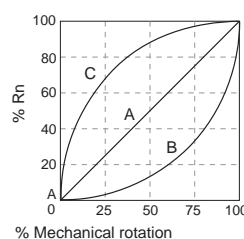

A: Lin.
B: Log.
C: Alog.

POWER RATING CURVE

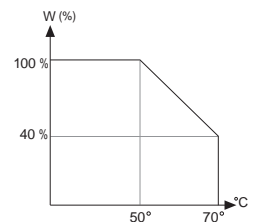

TESTS

TYPICAL VARIATIONS

ELECTRICAL LIFE	1.000 h. 50°C; 0.25 W	±5 %
MECHANICAL LIFE* :	25.000 (10-15 CPM)	±3 % (Rn < 1 M)
TEMPERATURE COEFFICIENT	-25°C; +70°C	±300 ppm (Rn < 100 K)
THERMAL CYCLING	16 h. @ 85°C; 2h. @ -25°C	±2.5 %
DAMP HEAT	500 h. 40°C 95% HR	±5 %
VIBRATION (for each plane X,Y,Z)	2 h. @ 10 Hz - 55 Hz.	±2 %

NOTE: Out of range values may not comply these results.

(*) only applicable to values ≥1K. For lower values please consult.

PACKAGING

Boxes of 150 / 200 pieces (160 x 110 x 85 mm.)

SWITCH F1

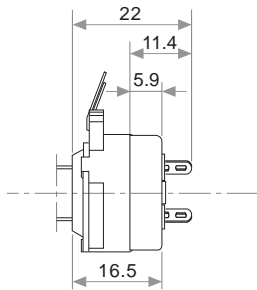

MECHANICAL & ELECTRICAL SPECIFICATIONS	F 1
OPERATING ANGLE	50° ±5°
OPERATING TORQUE	3-7 Ncm (4.2-9.8 in-oz)
MAXIMUM AXIAL CHARGE	80 N; 17 pounds
NOMINAL CURRENT	1A; 250 VAC
CONTACT RESISTANCE	≤ 25mΩ
TEST VOLTAGE (DIELECTRIC STRENGTH)	2000 V (50 Hz)

SWITCH F2

ELECTRICAL SPECIFICATIONS	F 2
SWITCH RATING	2 or 4A; 250 VAC
CONTACT RESISTANCE	≤ 25 mΩ
DIELECTRIC STRENGTH	2000 V
INSULATION RESISTANCE	100 MΩ
MECHANICAL SPECIFICATIONS	F 2
OPERATING ANGLE (ROTARY)	35° ± 5°
PUSH / PUSH OPERATING TRAVEL	4 mm.
PUSH / PULL OPERATING TRAVEL	2.5 mm.
OPERATING TORQUE (ROTARY)	2 to 9 Ncm. (2.8 to 12.7oz/in)
OPERATING FORCE (Push/Push ; Push/Pull)	4 to 7 N (14 to 27oz)
MECHANICAL LIFE	10.000 cycles
STOP TORQUE	> 100 Ncm. (142 oz/in)

ROTARY

PUSH

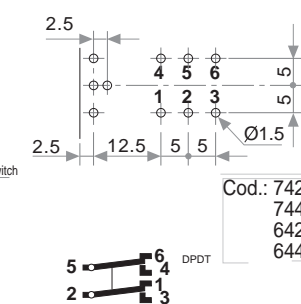
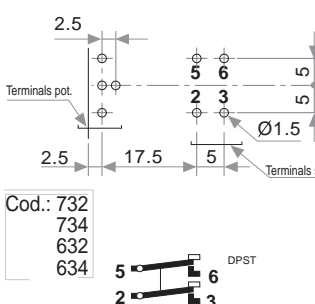
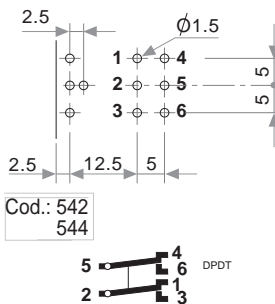
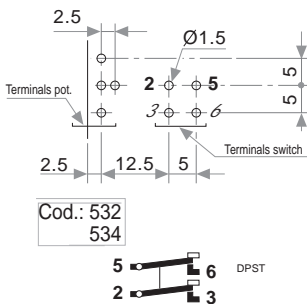
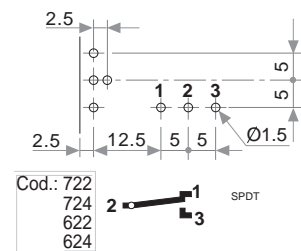
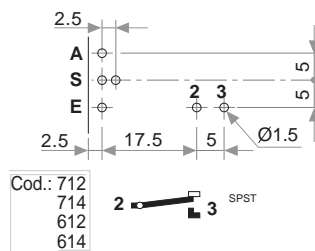
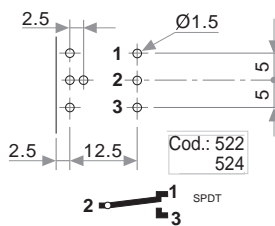
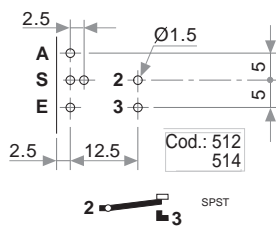
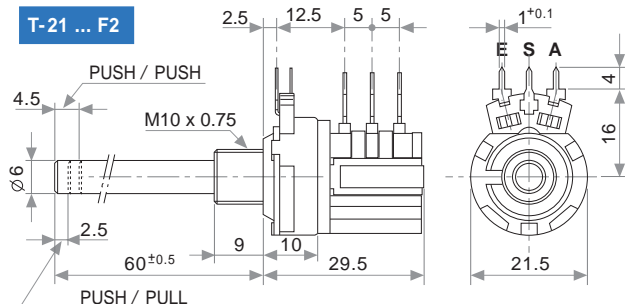
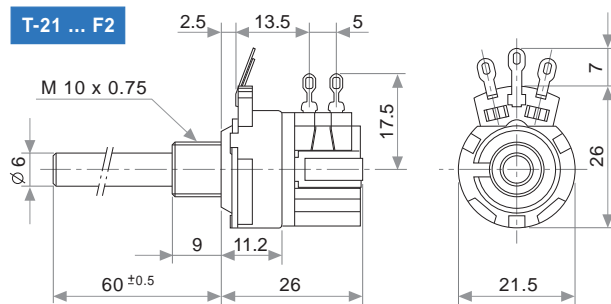

I-21 HOW TO ORDER (only switch)

STANDARD

OPTIONAL

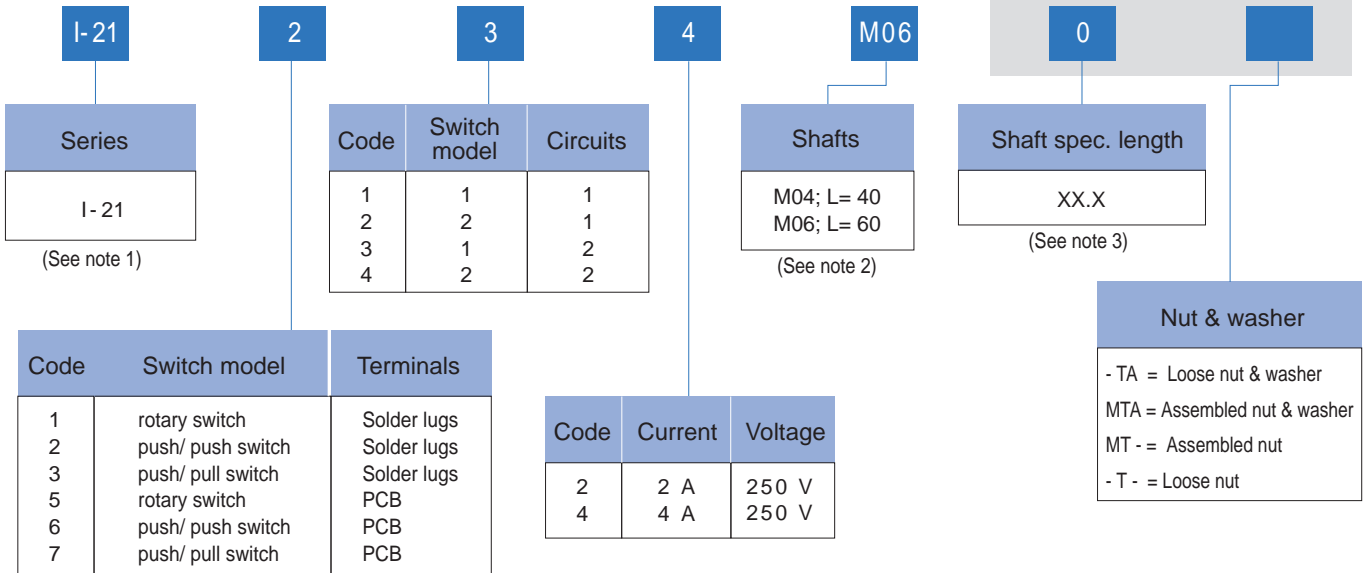

NOTES:

- When only the switch is ordered (without potentiometer), it will be called "I-21" followed by the respective code.
- The shaft and bushing for "I-21" is:

COD.	A	B	L
M06	6	M10 x 0.75	60

- Only for special length and plain shaft (not knurled).
Example: E: Ø6 L= 24.5 M06 24.5 → special length
Flatted and slotted shafts, etc. will need drawing.

HOW TO ORDER CUSTOM DRAWING

STANDARD OPTIONS

I-21 + DRAWING NUMBER (Max. 16 digits)

This way of ordering should be used for options which are not included in the "How to order" standard and optional extras.

Shaft length See note 2

Nut & washer Without nut and washer

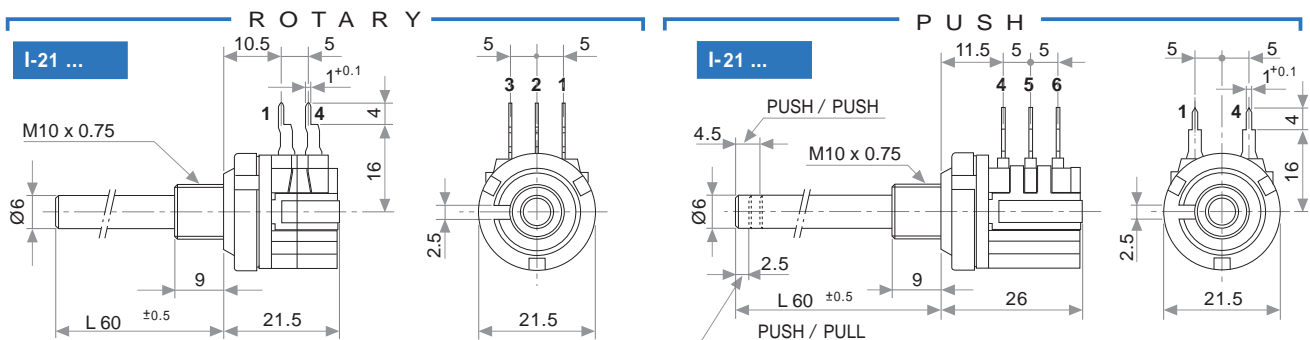

NUT & WASHER

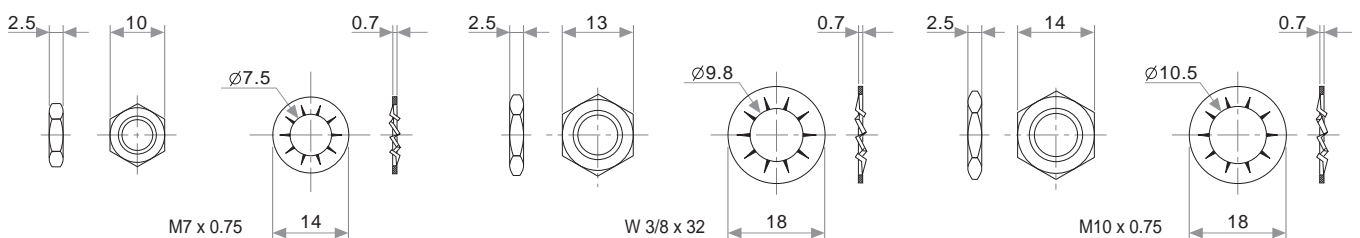

PACKAGING

Boxes of 100 pieces (160 x 110 x 85 mm.).

OPEN CIRCUIT FEATURE (CUT TRACK)

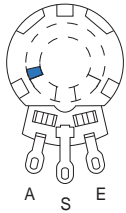

PCI
Cut track at the beginning of the travel.

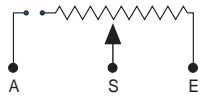

CCW on-off (A)

PCF
Cut track at the end of the travel

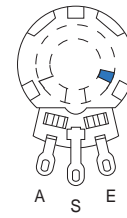
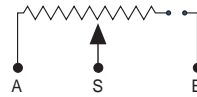

CW on-off (E)

A = Initial S = Wiper E = Final.

PCI, PCF and other configurations available upon request. Check the ordering code with Piher.

RECOMMENDED CONNECTIONS

Piher potentiometer's recommended connection circuit for a position sensor or control application. (voltage divider circuit electronic design).

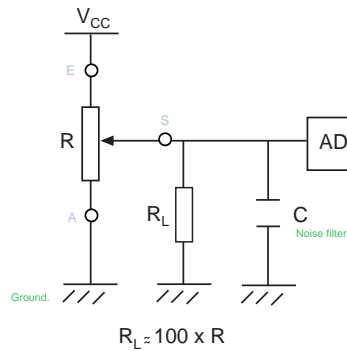

Disclaimer

The product information in this catalogue is for reference purposes. Please consult for the most up to date and accurate design information.

Piher Sensors & Controls S.A., its affiliates, agents, and employees, and all persons acting on its or their behalf (collectively, "Piher"), disclaim any and all liability for any errors, inaccuracies or incompleteness contained herein or in any other disclosure relating to any product described herein.

Piher disclaims any and all liability arising out of the use or application of any product described herein or of any information provided herein to the maximum extent permitted by law. The product specifications do not expand or otherwise modify Piher's terms and conditions of sale, including but not limited to the warranty expressed therein, which apply to these products.

No licence, express or implied, by estoppel or otherwise, to any intellectual property rights is granted by this document or by any conduct of Piher.

The products shown herein are not designed for use in medical, life-saving, or life-sustaining applications unless otherwise expressly indicated. Customers using or selling Piher products not expressly indicated for use in such applications do so entirely at their own risk and agree to fully indemnify Piher for any damages arising or resulting from such use or sale. Please contact authorised Piher personnel to obtain written terms and conditions regarding products designed for such applications.

Product names and markings noted herein may be trademarks of their respective owners.

Information contained in and/or attached to this catalogue may be subject to export control regulations of the European Community, USA, or other countries. Each recipient of this document is responsible to ensure that usage and/or transfer of any information contained in this document complies with all relevant export control regulations. If you are in any doubt about the export control restrictions that apply to this information, please contact the sender immediately. For any Piher International Corp. Exports, Note: All products / technologies are EAR99 Classified commodities. Exports from the United States are in accordance with the Export Administration Regulations. Diversion contrary to US law is prohibited.

Piher is an Amphenol™ company.



Contact

Piher Sensors & Controls SA

Polígono Industrial Municipal
Vial T2, 22,
31500 Tudela - Spain.
t. +34-948-820450
f. +34-948-824050

sales@piher.net

www.piher.net



Note: Piher products can be adapted to meet customer's requirements. Due to continuous process improvement, specifications are subject to change without notice.

v080518

PIHER