

CDST-2004S-HF

RoHS Device

Halogen Free

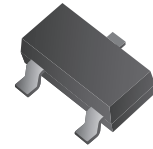

Features

- Design for mounting on small surface.
- High speed switching.
- High mounting capability, strong surge withstand, high reliability.

Mechanical data

- Case: SOT-23
- Terminals: Solder plated, solderable per MIL-STD-750, Method 2026.
- Weight: 0.0078 grams(approx.).

Circuit Diagram

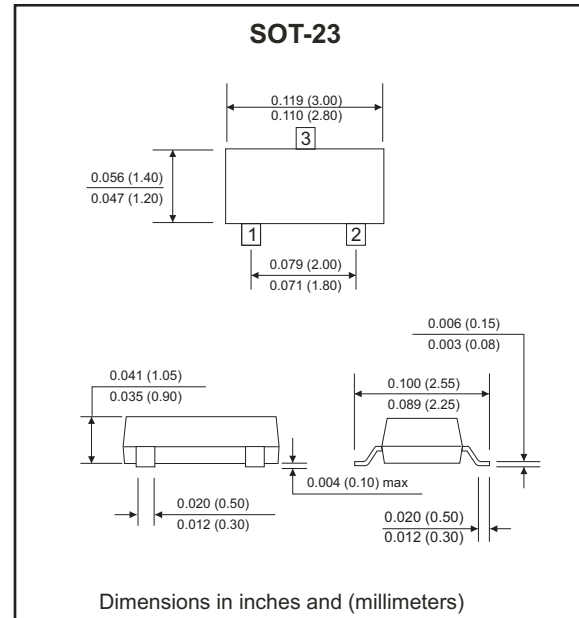
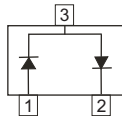

Maximum Rating (at TA=25°C unless otherwise noted)

Parameter	Symbol	Limits	Unit
Peak repetitive peak reverse voltage	V_{RRM}	300	V
Working peak reverse voltage	V_{RWM}	240	V
DC blocking voltage	V_R	240	V
RMS reverse voltage	$V_{R(RMS)}$	170	V
Forward continuous current	I_{FM}	225	mA
Peak repetitive forward current	I_{FRM}	625	mA
Peak forward surge current	I_{FSM}	4.0 1.0	A
	@t=1.0us		
	@t=1.0s		
Power dissipation	P_D	350	mW
Thermal resistance, junction to ambient	$R_{\theta JA}$	357	°C/W
Operating junction temperature	T_J, T_{STG}	-65 to +150	°C

Electrical Characteristics (at TA=25°C unless otherwise noted)

Parameter	Symbol	Test Conditions	Min	Max	Unit
Reverse breakdown voltage	V_{BR}	$I_R=100\mu A$	300		V
Reverse leakage current	I_R	$V_R=240V$ $V_R=240V, T_J = 150^\circ C$		100	nA μA
Forward voltage	V_F	$I_F=20mA$ $I_F=100mA$		0.87 1.0	V
Diode capacitance	C_T	$V_R=0V, f=1MHz$		5.0	pF
Reverse recovery time	t_{rr}	$I_F = I_R = 30mA,$ $I_{rr} = 3.0mA, R_L = 100\Omega$		50	ns

Electrical and Characteristic Curves (CDST-2004S-HF)

Fig.1- Power Derating

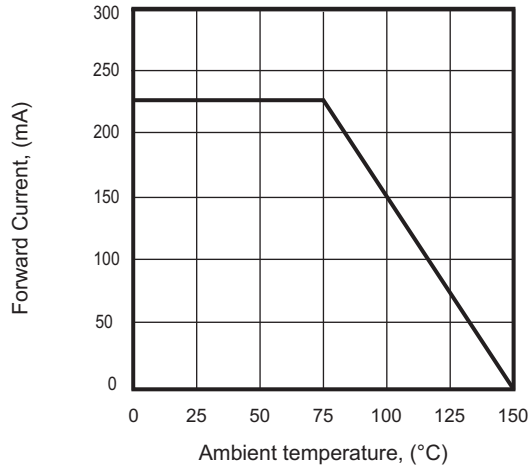

Fig.2- Typical Forward Characteristics

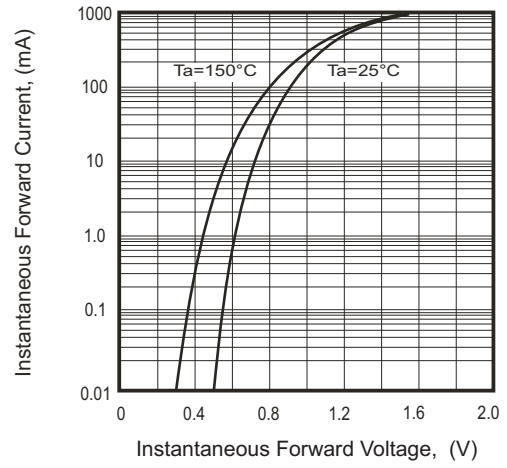

Fig.3- Typical Diode Capacitance Characteristics

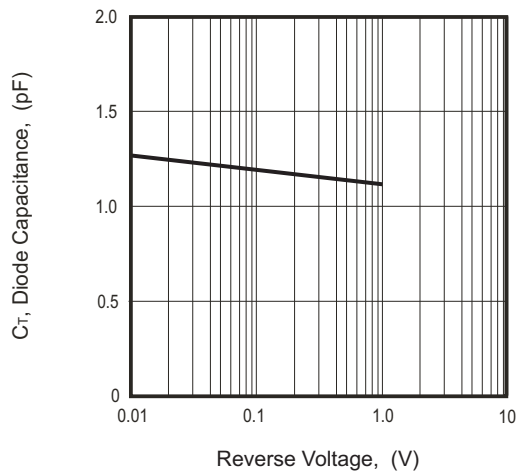
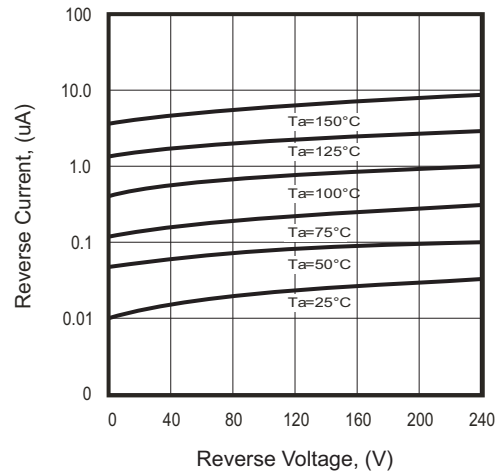
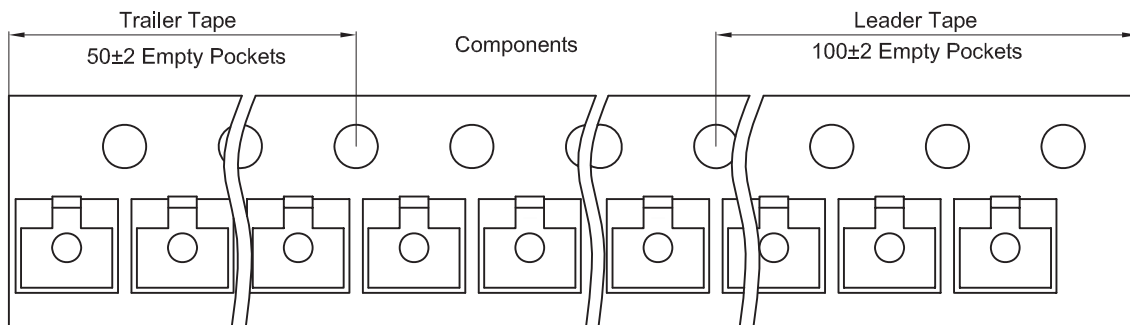
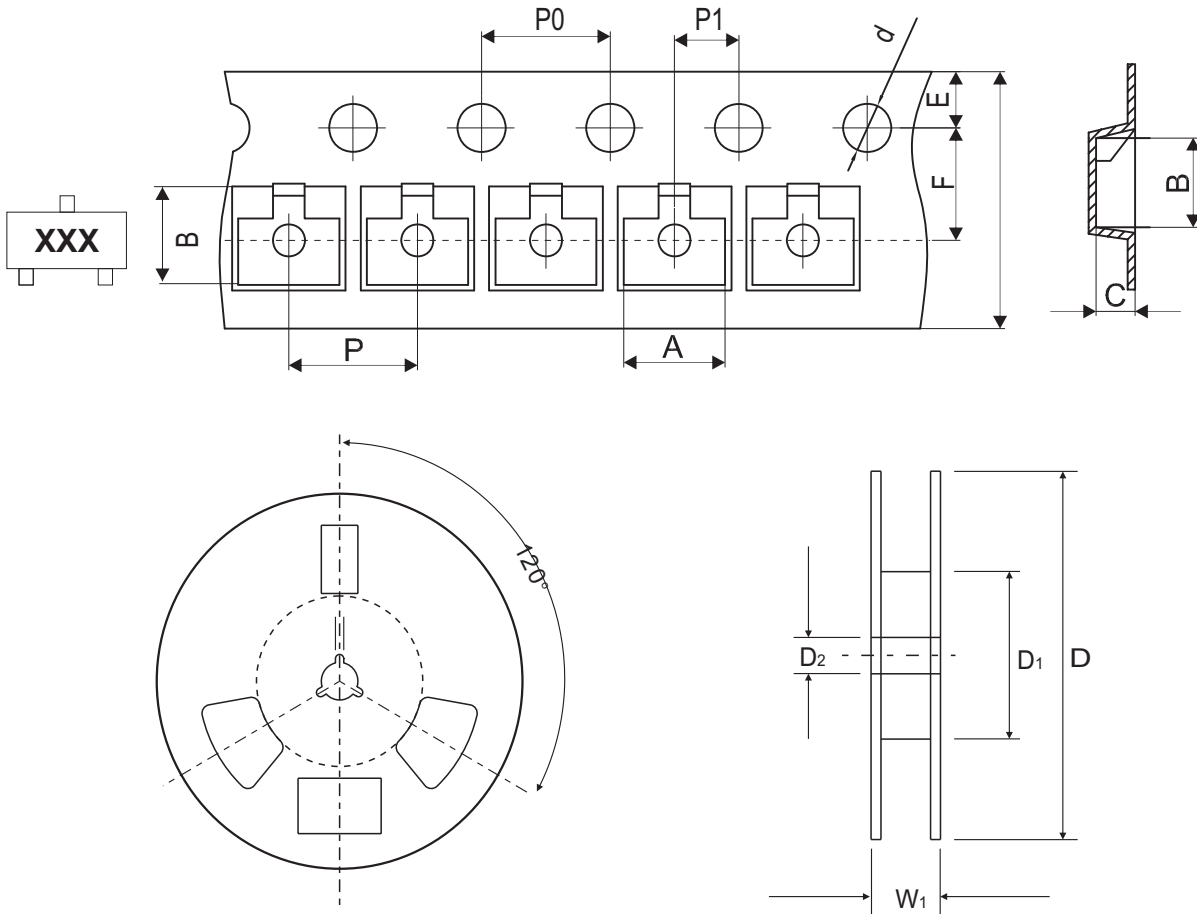

Fig.4- Typical Reverse Current Characteristics



Reel Taping Specification



SOT-23	SYMBOL	A	B	C	d	D	D1	D2
	(mm)	3.15 ± 0.10	2.77 ± 0.10	1.22 ± 0.10	1.50 ± 0.10	178 ± 2.00	54.40 ± 1.00	13.00 ± 1.00
	(inch)	0.124 ± 0.004	0.109 ± 0.004	0.048 ± 0.004	0.059 ± 0.004	7.008 ± 0.079	2.142 ± 0.039	0.512 ± 0.039

SOT-23	SYMBOL	E	F	P	P0	P1	W	W1
	(mm)	1.75 ± 0.10	3.50 ± 0.10	4.00 ± 0.10	4.00 ± 0.10	2.00 ± 0.10	8.00 + 0.30 / - 0.10	12.30 ± 1.0
	(inch)	0.069 ± 0.004	0.138 ± 0.004	0.157 ± 0.004	0.157 ± 0.004	0.079 ± 0.004	0.315 + 0.012 / - 0.004	0.484 ± 0.039

Company reserves the right to improve product design, functions and reliability without notice.

REV:A

Marking Code

Part Number	Marking Code
CDST-2004S-HF	S6

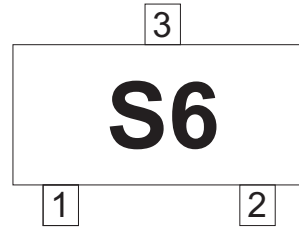

Suggested PAD Layout

SIZE	SOT-23	
	(mm)	(inch)
A	0.80	0.031
B	1.90	0.075
C	2.02	0.080
D	2.82	0.111

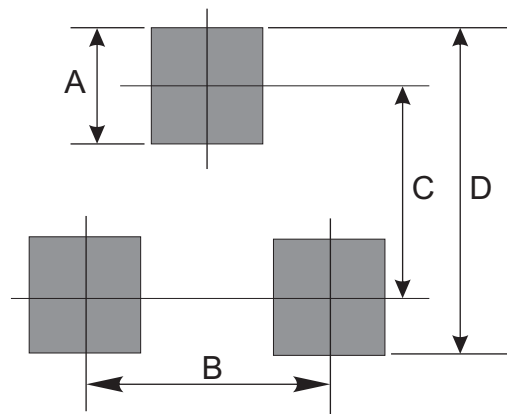

Standard Packaging

Case Type	Qty per Reel	Reel Size
	(Pcs)	(inch)
SOT-23	3,000	7