

Mounting Option

Ø.156" (Ø3.96mm) Mounting Holes

Contact Detail

527 - P.C Tail .046 x .013 (1.17 x 0.33)

THIS IS A C.A.D. GENERATED DRAWING
DO NOT MAKE MANUAL REVISIONS TO MASTER.



ISSUE NUMBER

ORIGINAL ①

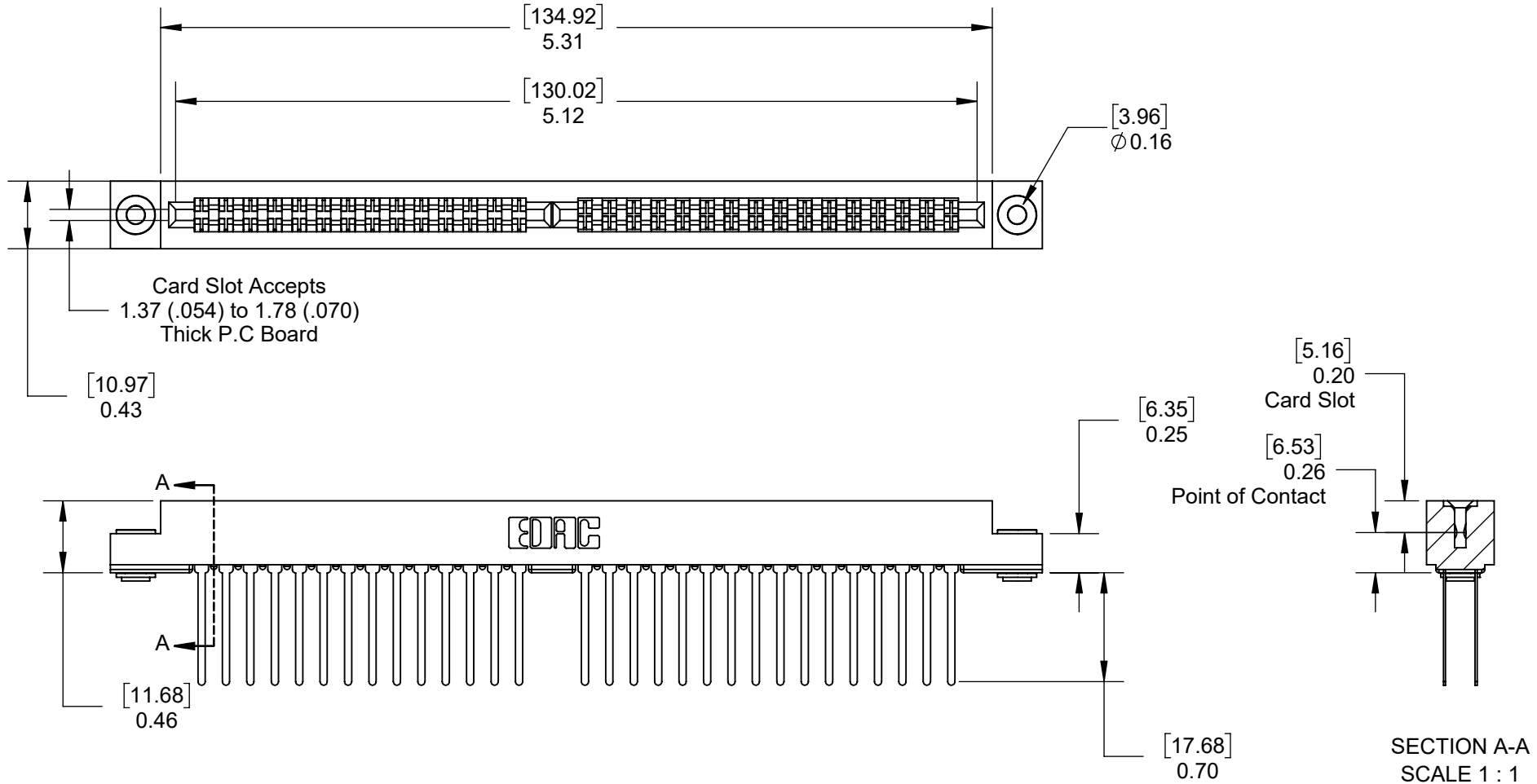

310 SERIES CARD EDGE CONNECTOR



YOUR CONNECTION TO QUALITY & SERVICE

EDAC INC
TORONTO, ONTARIO
CANADA

THESE DRAWINGS AND SPECIFICATIONS
ARE THE PROPERTY OF EDAC INC., AND
SHALL NOT BE REPRODUCED, OR COPIED
OR USED AS THE BASIS FOR THE
MANUFACTURE OR SALE OF APPARATUS
WITHOUT WRITTEN PERMISSION.

DRAWN: W.TU	DATE: 2020-03-25
CHECKED:	DATE:
PART NUMBER 310-060-540-203	
SHEET 1 OF 1	
DRAWING NUMBER 310 ASSEMBLY	ISSUE 1