

MIRELLA-50-W-PF

~40° wide beam

TECHNICAL SPECIFICATIONS:

Dimensions	Ø 49.9 mm
Height	24 mm
Fastening	socket
Colour	metal
Box size	480 x 280 x 300 mm
Box weight	2.8 kg
Quantity in Box	336 pcs
ROHS compliant	yes ⓘ



MATERIAL SPECIFICATIONS:

Component	Type	Material	Colour	Coating
MIRELLA-50-W-PF	Reflector	PC	metal	lacquer

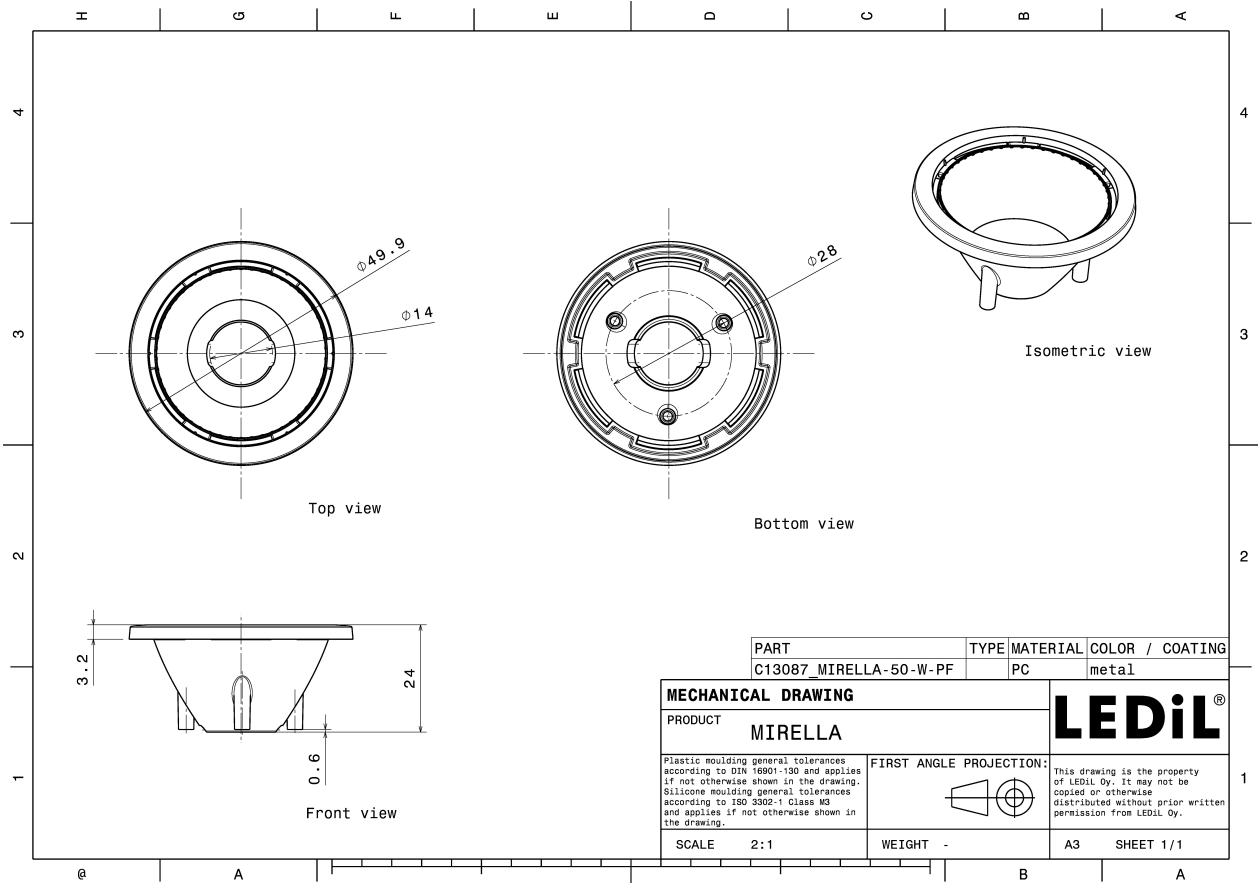

PHOTOMETRIC DATA (MEASURED):

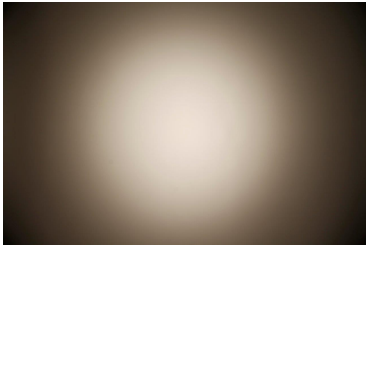
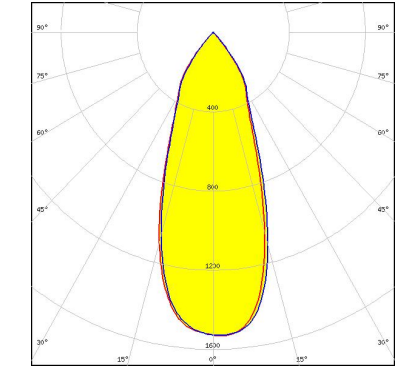
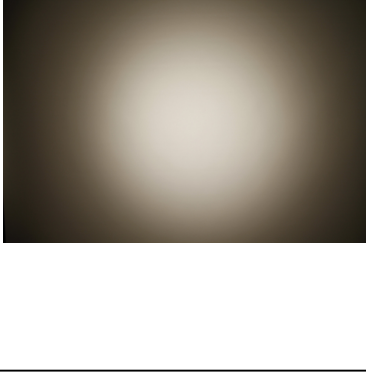
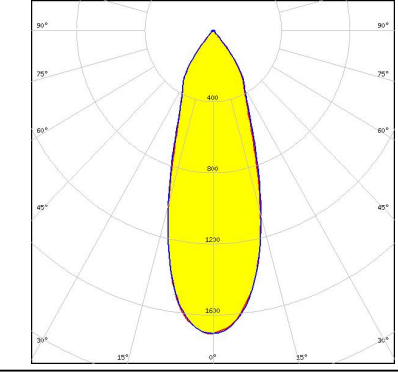
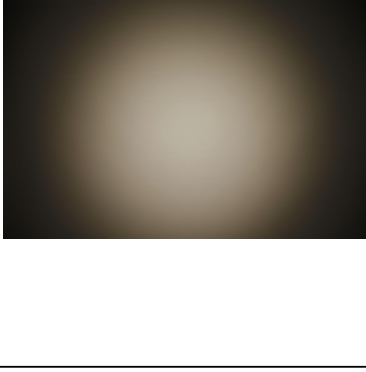
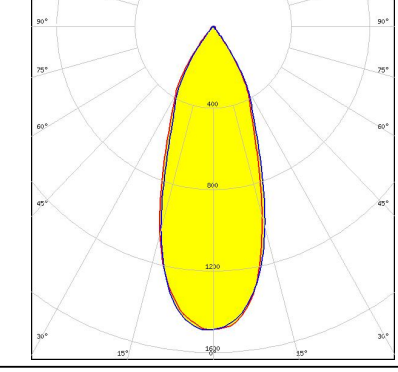
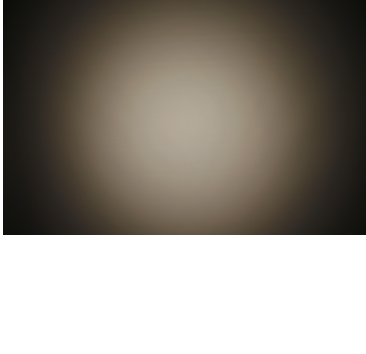
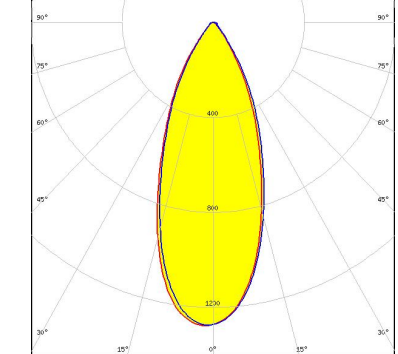
<p>bridgelux.</p> <p>LED V10 Gen6</p> <p>FWHM 39.0°</p> <p>Efficiency 86 %</p> <p>Peak intensity 1.500 cd/lm</p> <p>LEDs/each optic 1</p> <p>Light colour White</p> <p>Required components: C14115_PF-SOCKET-CXA15-18</p>		
<p>bridgelux.</p> <p>LED V10 Gen7</p> <p>FWHM 35.0°</p> <p>Efficiency 84 %</p> <p>Peak intensity 1.700 cd/lm</p> <p>LEDs/each optic 1</p> <p>Light colour White</p> <p>Required components: C13709_PF-SOCKET-VERO13-18</p>		
<p>bridgelux.</p> <p>LED V10 Gen7</p> <p>FWHM 39.0°</p> <p>Efficiency 79 %</p> <p>Peak intensity 1.500 cd/lm</p> <p>LEDs/each optic 1</p> <p>Light colour White</p> <p>Required components: C13709_PF-SOCKET-VERO13-18 C13333_MIRELLA-CL</p>		
<p>bridgelux.</p> <p>LED V10 Gen7</p> <p>FWHM 40.0°</p> <p>Efficiency 77 %</p> <p>Peak intensity 1.300 cd/lm</p> <p>LEDs/each optic 1</p> <p>Light colour White</p> <p>Required components: C13709_PF-SOCKET-VERO13-18 C12479_MIRELLA-DL</p>		

PHOTOMETRIC DATA (MEASURED):

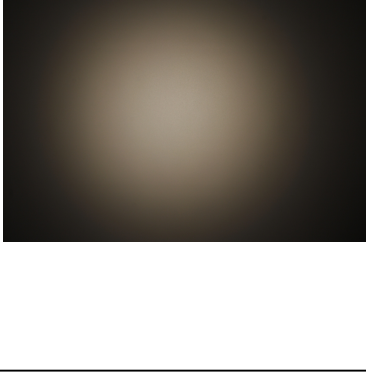
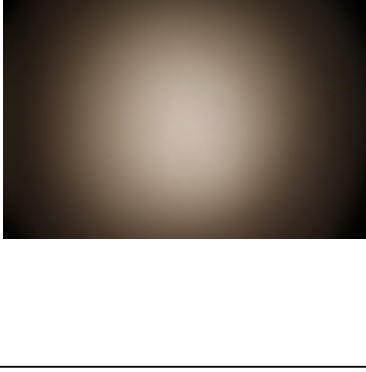
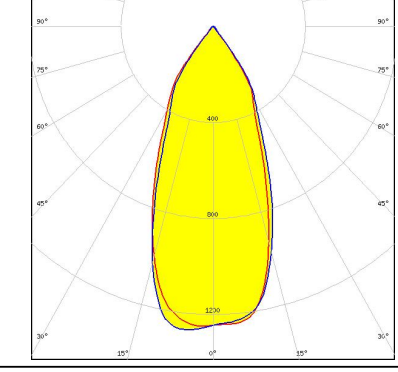
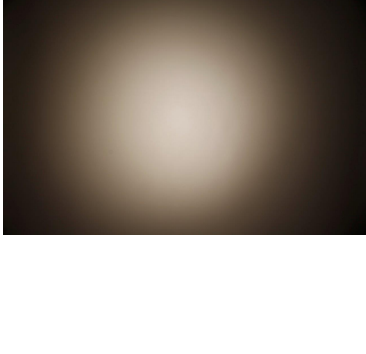
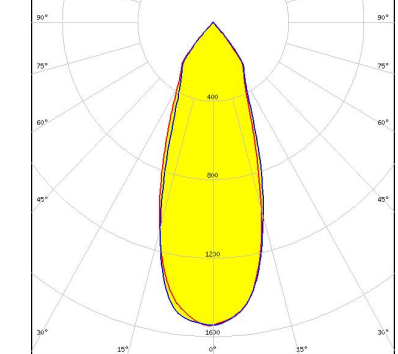
<p>bridgelux.</p> <p>LED V6 Gen6</p> <p>FWHM 27.0°</p> <p>Efficiency 82 %</p> <p>Peak intensity 2.690 cd/lm</p> <p>LEDs/each optic 1</p> <p>Light colour White</p> <p>Required components: C13709_PF-SOCKET-VERO13-18 Bender Wirth: 460 Typ L1</p>		
<p>bridgelux.</p> <p>LED V6 Gen6</p> <p>FWHM 31.0°</p> <p>Efficiency 74 %</p> <p>Peak intensity 2.100 cd/lm</p> <p>LEDs/each optic 1</p> <p>Light colour White</p> <p>Required components: C13709_PF-SOCKET-VERO13-18 C12479_MIRELLA-DL Bender Wirth: 460 Typ L1</p>		
<p>bridgelux.</p> <p>LED V6 Gen6</p> <p>FWHM 44.0°</p> <p>Efficiency 81 %</p> <p>Peak intensity 1.300 cd/lm</p> <p>LEDs/each optic 1</p> <p>Light colour White</p> <p>Required components: C13761_PF-SOCKET-CXA15 C13333_MIRELLA-CL</p>		
<p>bridgelux.</p> <p>LED V6 Gen6</p> <p>FWHM 39.0°</p> <p>Efficiency 87 %</p> <p>Peak intensity 1.500 cd/lm</p> <p>LEDs/each optic 1</p> <p>Light colour White</p> <p>Required components: C13761_PF-SOCKET-CXA15</p>		



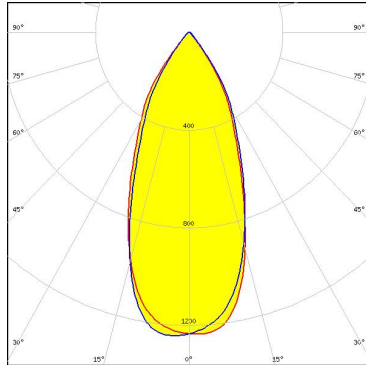
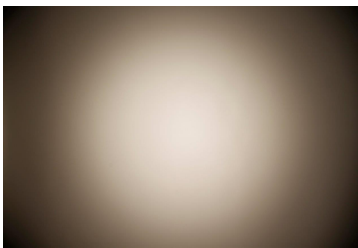
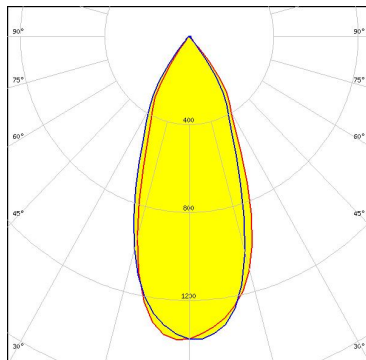
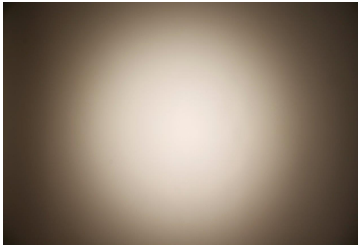
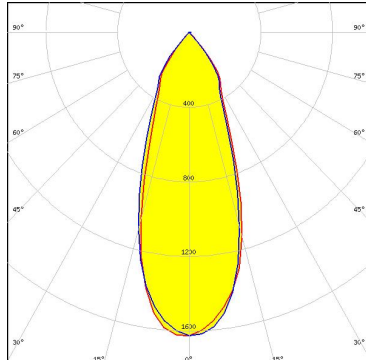
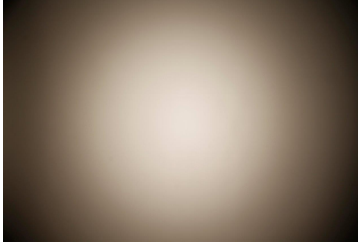
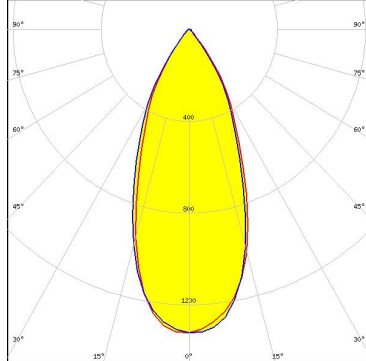

PHOTOMETRIC DATA (MEASURED):

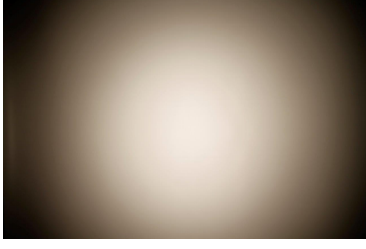
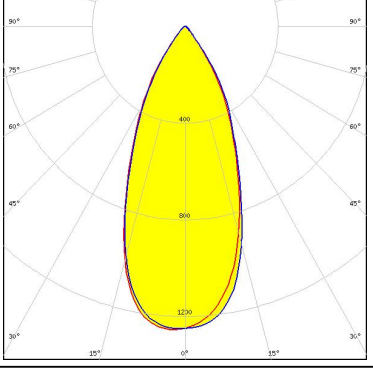
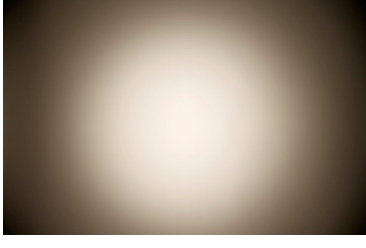
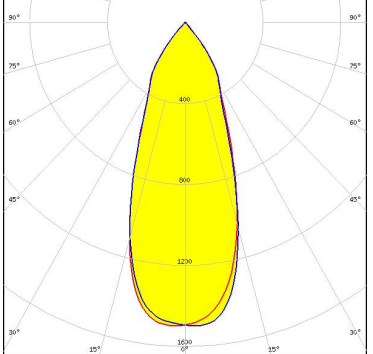
<p>bridgelux.</p> <p>LED V6 Gen6</p> <p>FWHM 44.0°</p> <p>Efficiency 81 %</p> <p>Peak intensity 1.250 cd/lm</p> <p>LEDs/each optic 1</p> <p>Light colour White</p> <p>Required components: C13761_PF-SOCKET-CXA15 C12479_MIRELLA-DL</p>		
<p>bridgelux.</p> <p>LED V8 Gen6</p> <p>FWHM 42.0°</p> <p>Efficiency 82 %</p> <p>Peak intensity 1.380 cd/lm</p> <p>LEDs/each optic 1</p> <p>Light colour White</p> <p>Required components: C13761_PF-SOCKET-CXA15 C13333_MIRELLA-CL</p>		
<p>bridgelux.</p> <p>LED V8 Gen6</p> <p>FWHM 38.0°</p> <p>Efficiency 87 %</p> <p>Peak intensity 1.600 cd/lm</p> <p>LEDs/each optic 1</p> <p>Light colour White</p> <p>Required components: C13761_PF-SOCKET-CXA15</p>		
<p>bridgelux.</p> <p>LED V8 Gen6</p> <p>FWHM 43.0°</p> <p>Efficiency 82 %</p> <p>Peak intensity 1.330 cd/lm</p> <p>LEDs/each optic 1</p> <p>Light colour White</p> <p>Required components: C13761_PF-SOCKET-CXA15 C12479_MIRELLA-DL</p>		

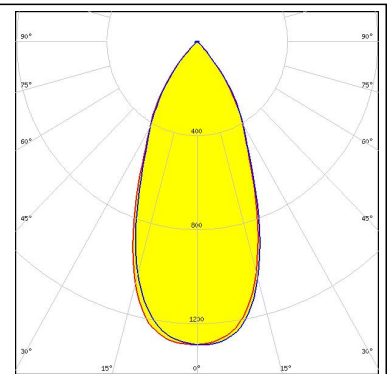
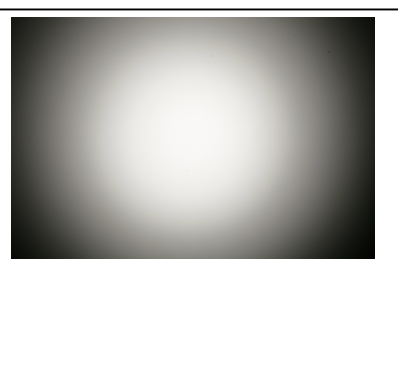
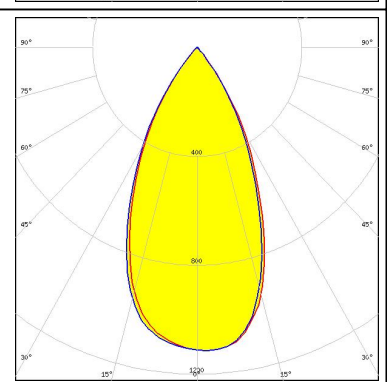

PHOTOMETRIC DATA (MEASURED):

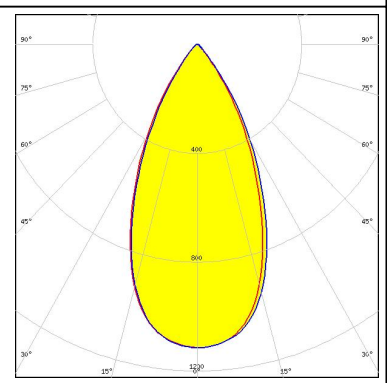
<p>bridgelux.</p> <p>LED V8 Gen6</p> <p>FWHM 36.0°</p> <p>Efficiency 73 %</p> <p>Peak intensity 1.800 cd/lm</p> <p>LEDs/each optic 1</p> <p>Light colour White</p> <p>Required components:</p> <p>C13709_PF-SOCKET-VERO13-18</p> <p>C12479_MIRELLA-DL</p> <p>Bender Wirth: 460 Typ L1</p>		
<p>bridgelux.</p> <p>LED VERO10</p> <p>FWHM 44.0°</p> <p>Efficiency 80 %</p> <p>Peak intensity 1.300 cd/lm</p> <p>LEDs/each optic 1</p> <p>Light colour White</p> <p>Required components:</p> <p>C13708_PF-SOCKET-VERO10</p> <p>C13333_MIRELLA-CL</p>		
<p>bridgelux.</p> <p>LED VERO10</p> <p>FWHM 44.0°</p> <p>Efficiency 80 %</p> <p>Peak intensity 1.300 cd/lm</p> <p>LEDs/each optic 1</p> <p>Light colour White</p> <p>Required components:</p> <p>C13708_PF-SOCKET-VERO10</p> <p>C12479_MIRELLA-DL</p>		
<p>bridgelux.</p> <p>LED VERO10</p> <p>FWHM 40.0°</p> <p>Efficiency 85 %</p> <p>Peak intensity 1.500 cd/lm</p> <p>LEDs/each optic 1</p> <p>Light colour White</p> <p>Required components:</p> <p>C13708_PF-SOCKET-VERO10</p>		

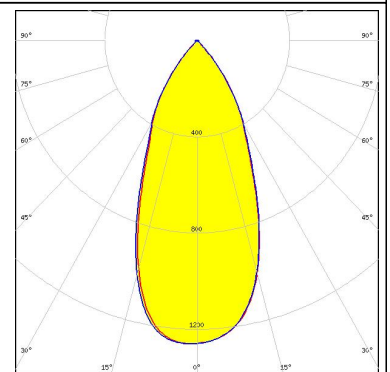
PHOTOMETRIC DATA (MEASURED):

<p>bridgelux.</p> <p>LED VERO13 FWHM 46.0° Efficiency 90 % Peak intensity 1.290 cd/lm LEDs/each optic 1 Light colour White Required components: C13709_PF-SOCKET-VERO13-18</p>		
<p>bridgelux.</p> <p>LED VERO13 FWHM 51.0° Efficiency 77 % Peak intensity 1.100 cd/lm LEDs/each optic 1 Light colour White Required components: C13709_PF-SOCKET-VERO13-18 C13333_MIRELLA-CL</p>		
<p>bridgelux.</p> <p>LED VERO13 FWHM 50.0° Efficiency 82 % Peak intensity 1.120 cd/lm LEDs/each optic 1 Light colour White Required components: C13709_PF-SOCKET-VERO13-18 C12479_MIRELLA-DL</p>		
<p>bridgelux.</p> <p>LED Xenio Point 13mm FWHM 45.0° Efficiency 85 % Peak intensity 1.260 cd/lm LEDs/each optic 1 Light colour White Required components: C13709_PF-SOCKET-VERO13-18</p>		

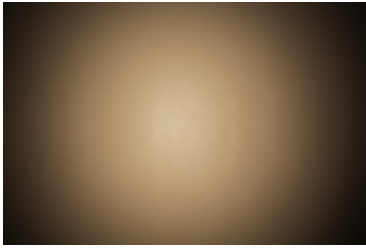
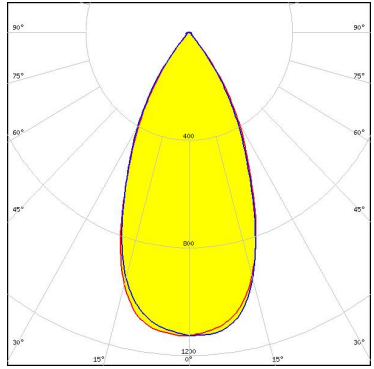
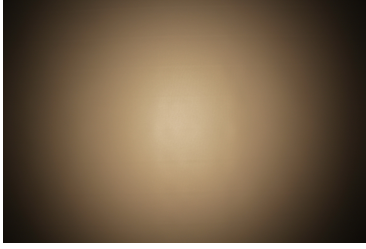
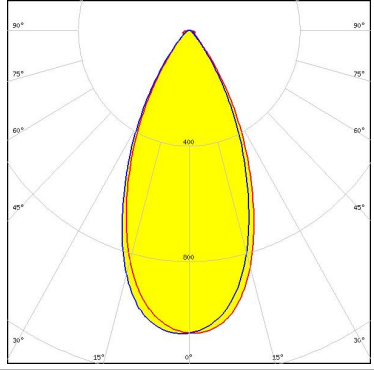
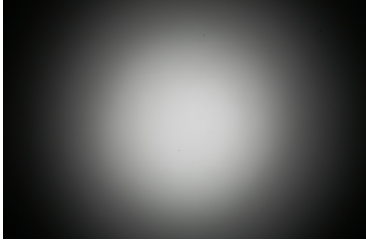
PHOTOMETRIC DATA (MEASURED):

<p>bridgelux</p> <p>LED Xenio Point 13mm FWHM 49.0° Efficiency 81 % Peak intensity 1.130 cd/lm LEDs/each optic 1 Light colour White Required components: C13709_PF-SOCKET-VERO13-18 C13333_MIRELLA-CL</p>		
<p>bridgelux</p> <p>LED Xenio Point 13mm FWHM 48.0° Efficiency 78 % Peak intensity 1.050 cd/lm LEDs/each optic 1 Light colour White Required components: C13709_PF-SOCKET-VERO13-18 C12479_MIRELLA-DL</p>		
<p>CITIZEN</p> <p>LED CLL01x FWHM 44.0° Efficiency 86 % Peak intensity 1.400 cd/lm LEDs/each optic 1 Light colour White Required components: C13083_PF-SOCKET C12479_MIRELLA-DL</p>		
<p>CITIZEN</p> <p>LED CLL01x FWHM 42.0° Efficiency 86 % Peak intensity 1.400 cd/lm LEDs/each optic 1 Light colour White Required components: C13083_PF-SOCKET C13333_MIRELLA-CL</p>		

PHOTOMETRIC DATA (MEASURED):

CITIZEN

LED CLL01x
FWHM 36.0°
Efficiency 90 %
Peak intensity 1.800 cd/lm
LEDs/each optic 1
Light colour White
Required components:
C13083_PF-SOCKET



CITIZEN

LED CLL02x/CLU02x (LES10)
FWHM 41.0°
Efficiency 76 %
Peak intensity 1.300 cd/lm
LEDs/each optic 1
Light colour White
Required components:
C13709_PF-SOCKET-VERO13-18
C12479_MIRELLA-DL
Bender Wirth: 434 Typ L1

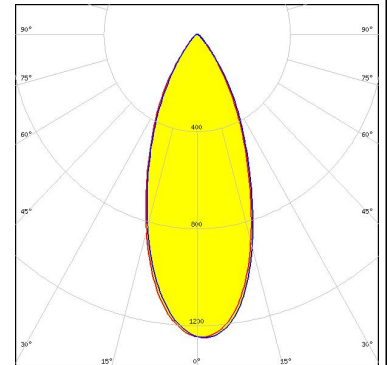
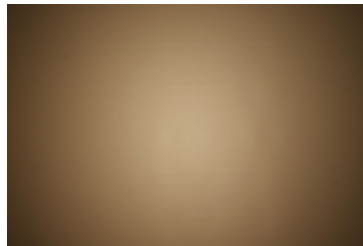

CITIZEN

LED CLL02x/CLU02x (LES10)
FWHM 46.0°
Efficiency 86 %
Peak intensity 1.500 cd/lm
LEDs/each optic 1
Light colour White
Required components:
C13083_PF-SOCKET
C12479_MIRELLA-DL

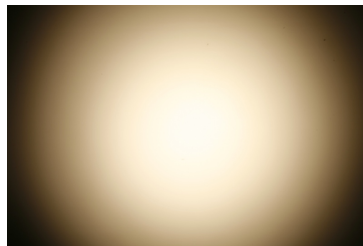

CITIZEN

LED CLL02x/CLU02x (LES10)
FWHM 36.0°
Efficiency 84 %
Peak intensity 1.700 cd/lm
LEDs/each optic 1
Light colour White
Required components:
C13709_PF-SOCKET-VERO13-18
Bender Wirth: 434 Typ L1

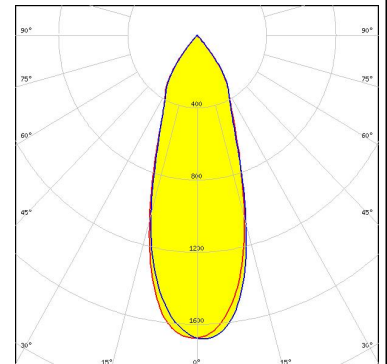
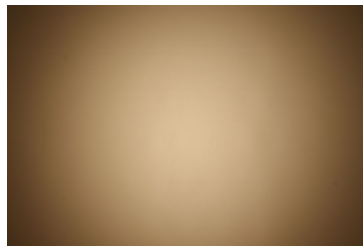

PHOTOMETRIC DATA (MEASURED):

CITIZEN

LED CLL02x/CLU02x (LES10)
 FWHM 41.0°
 Efficiency 90 %
 Peak intensity 1.800 cd/lm
 LEDs/each optic 1
 Light colour White
 Required components:
 C13083_PF-SOCKET



CITIZEN

LED CLL02x/CLU02x (LES10)
 FWHM 46.0°
 Efficiency 86 %
 Peak intensity 1.500 cd/lm
 LEDs/each optic 1
 Light colour White
 Required components:
 C13083_PF-SOCKET
 C13333_MIRELLA-CL

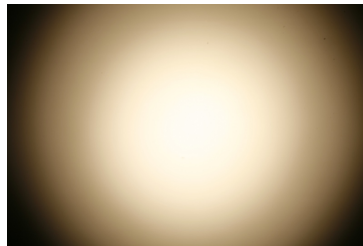

CITIZEN

LED CLL02x/CLU02x (LES10)
 FWHM 39.0°
 Efficiency 78 %
 Peak intensity 1.500 cd/lm
 LEDs/each optic 1
 Light colour White
 Required components:
 C13709_PF-SOCKET-VERO13-18
 C13333_MIRELLA-CL
 Bender Wirth: 434 Typ L1

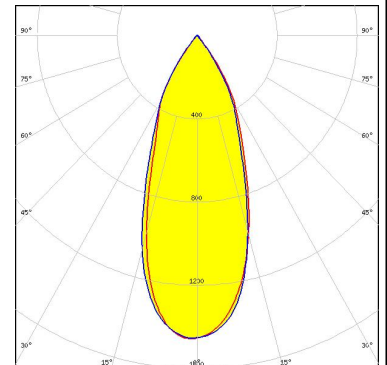
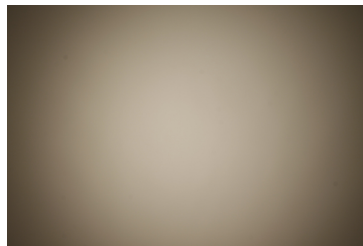

CITIZEN

LED CLL02x/CLU02x (LES10)
 FWHM 46.0°
 Efficiency %
 Peak intensity 0.700 cd/lm
 LEDs/each optic 1
 Light colour White
 Required components:
 C13083_PF-SOCKET
 C13723_MIRELLA-RZL

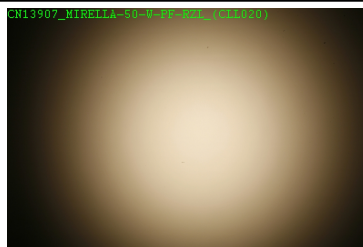

PHOTOMETRIC DATA (MEASURED):

CITIZEN

LED CLU700/701
 FWHM 33.0°
 Efficiency 88 %
 Peak intensity 1.900 cd/lm
 LEDs/each optic 1
 Light colour White
 Required components:
 C13083_PF-SOCKET

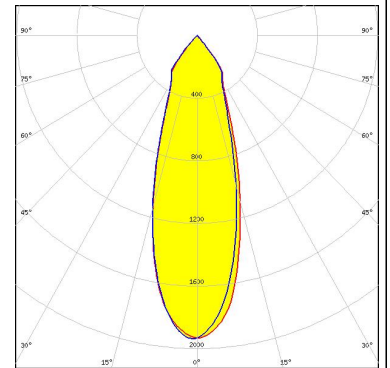

CITIZEN

LED CLU700/701
 FWHM 34.0°
 Efficiency 81 %
 Peak intensity 1.800 cd/lm
 LEDs/each optic 1
 Light colour White
 Required components:
 C13083_PF-SOCKET
 C13333_MIRELLA-CL

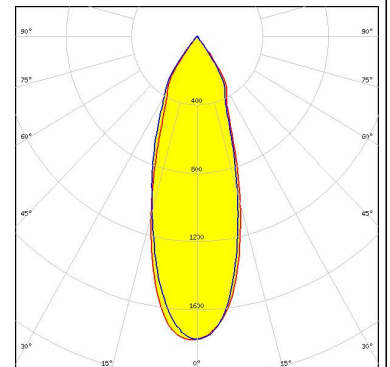
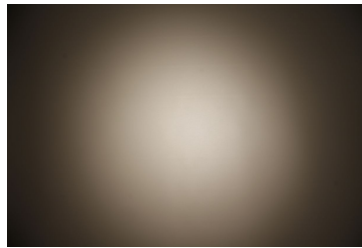

CITIZEN

LED CLU700/701
 FWHM 29.0°
 Efficiency 80 %
 Peak intensity 2.100 cd/lm
 LEDs/each optic 1
 Light colour White
 Required components:
 C13709_PF-SOCKET-VERO13-18
 C13333_MIRELLA-CL
 Bender Wirth: 434 Typ L1

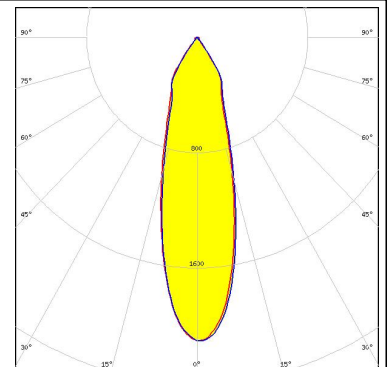
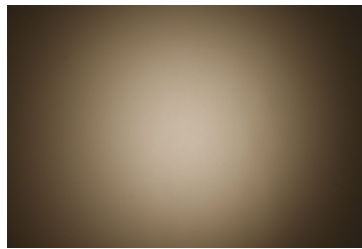

CITIZEN

LED CLU700/701
 FWHM 42.0°
 Efficiency 81 %
 Peak intensity 1.300 cd/lm
 LEDs/each optic 1
 Light colour White
 Required components:
 C13083_PF-SOCKET
 C13723_MIRELLA-RZL

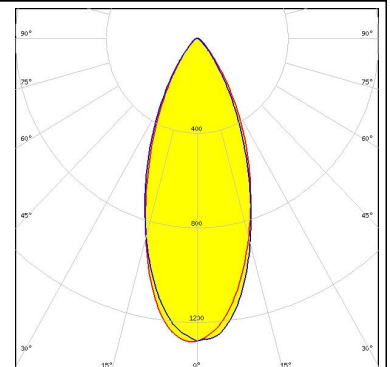
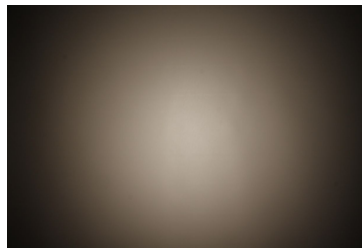

PHOTOMETRIC DATA (MEASURED):

CITIZEN

LED CLU700/701
 FWHM 39.0°
 Efficiency 82 %
 Peak intensity 1.400 cd/lm
 LEDs/each optic 1
 Light colour White
 Required components:
 C13083_PF-SOCKET
 C12479_MIRELLA-DL

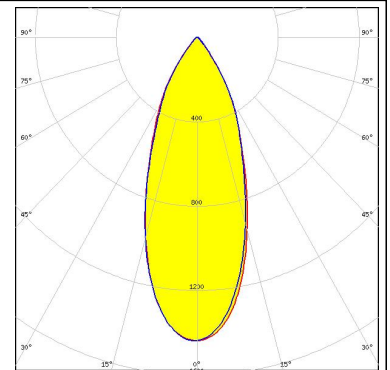

CITIZEN

LED CLU700/701
 FWHM 31.0°
 Efficiency 77 %
 Peak intensity 1.800 cd/lm
 LEDs/each optic 1
 Light colour White
 Required components:
 C13709_PF-SOCKET-VERO13-18
 C12479_MIRELLA-DL
 Bender Wirth: 434 Typ L1

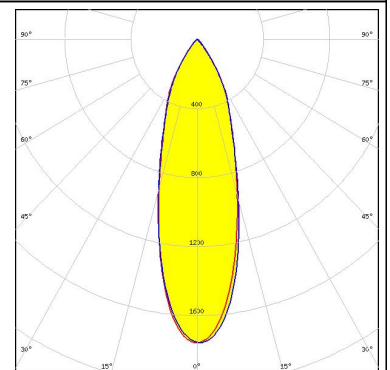
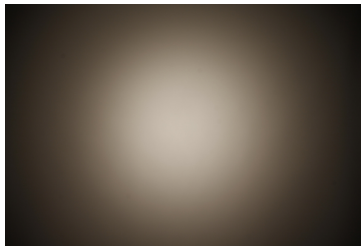

CITIZEN

LED CLU700/701
 FWHM 26.0°
 Efficiency 83 %
 Peak intensity 2.400 cd/lm
 LEDs/each optic 1
 Light colour White
 Required components:
 C13709_PF-SOCKET-VERO13-18
 Bender Wirth: 434 Typ L1

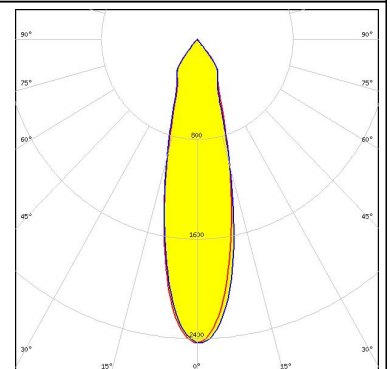
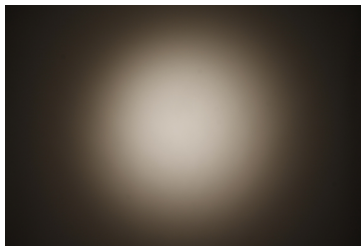

CITIZEN

LED CLU720/721
 FWHM 44.0°
 Efficiency 74 %
 Peak intensity 1.100 cd/lm
 LEDs/each optic 1
 Light colour White
 Required components:
 C13709_PF-SOCKET-VERO13-18
 C12479_MIRELLA-DL
 Bender Wirth: 433 Typ L1

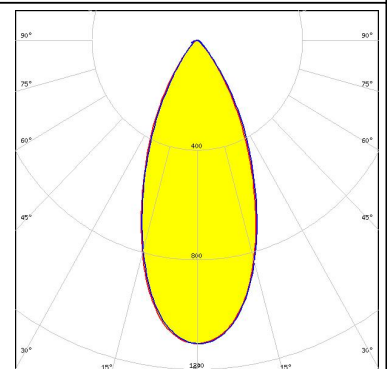
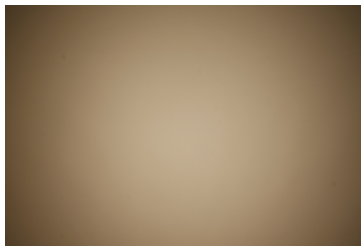

PHOTOMETRIC DATA (MEASURED):

CITIZEN

LED CLU720/721
 FWHM 40.0°
 Efficiency 81 %
 Peak intensity 1.400 cd/lm
 LEDs/each optic 1
 Light colour White
 Required components:
 C13709_PF-SOCKET-VERO13-18
 Bender Wirth: 433 Typ L1

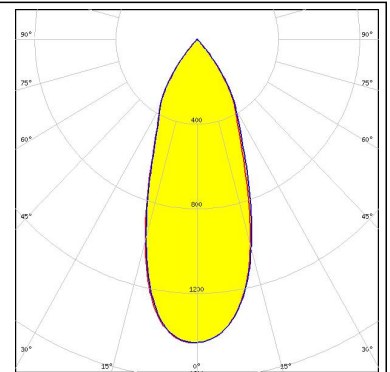
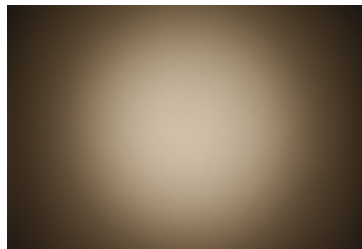

CITIZEN

LED CLU720/721
 FWHM 43.0°
 Efficiency 76 %
 Peak intensity 1.300 cd/lm
 LEDs/each optic 1
 Light colour White
 Required components:
 C13709_PF-SOCKET-VERO13-18
 C13333_MIRELLA-CL
 Bender Wirth: 433 Typ L1

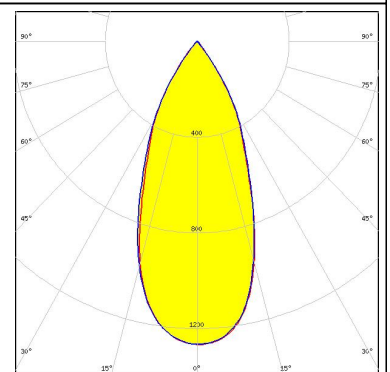
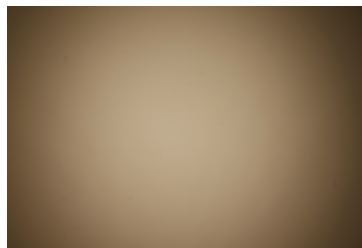

CREE

LED CXA/B 13xx
 FWHM 37.0°
 Efficiency 86 %
 Peak intensity 1.800 cd/lm
 LEDs/each optic 1
 Light colour White
 Required components:
 C13761_PF-SOCKET-CXA15

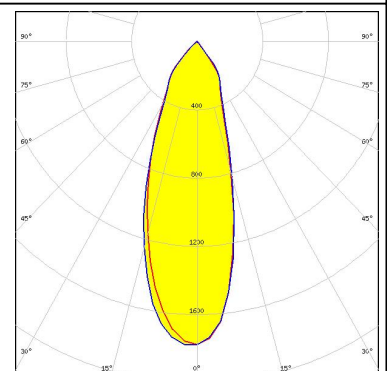
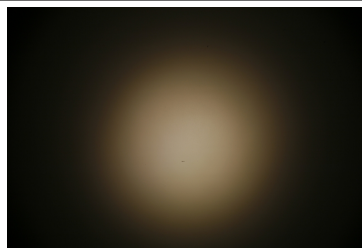

CREE

LED CXA/B 13xx
 FWHM 43.0°
 Efficiency 81 %
 Peak intensity 1.400 cd/lm
 LEDs/each optic 1
 Light colour White
 Required components:
 C13761_PF-SOCKET-CXA15
 C12479_MIRELLA-DL

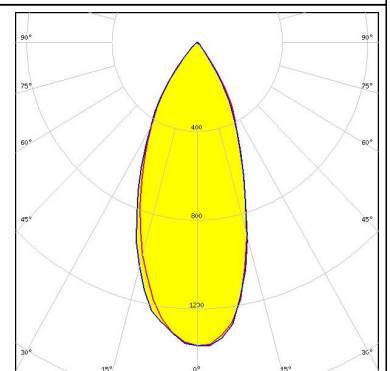
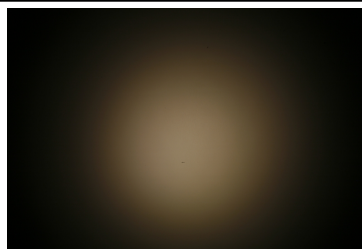

PHOTOMETRIC DATA (MEASURED):

CREE

LED CXA/B 13xx
 FWHM 42.0°
 Efficiency 81 %
 Peak intensity 1.500 cd/lm
 LEDs/each optic 1
 Light colour White
 Required components:
 C13761_PF-SOCKET-CXA15
 C13333_MIRELLA-CL



CREE

LED CXA/B 15xx
 FWHM 46.0°
 Efficiency 85 %
 Peak intensity 1.400 cd/lm
 LEDs/each optic 1
 Light colour White
 Required components:
 C13761_PF-SOCKET-CXA15
 C13333_MIRELLA-CL

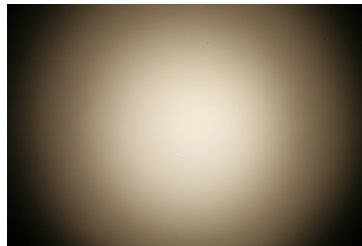

CREE

LED CXA/B 15xx
 FWHM 34.0°
 Efficiency 82 %
 Peak intensity 1.800 cd/lm
 LEDs/each optic 1
 Light colour White
 Required components:
 C13709_PF-SOCKET-VERO13-18
 Bender Wirth: 441 Typ L1

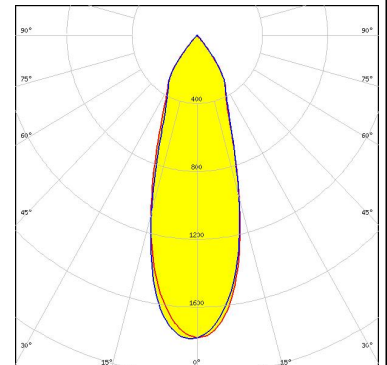
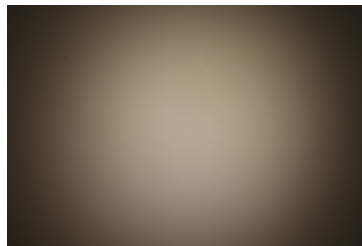

CREE

LED CXA/B 15xx
 FWHM 47.0°
 Efficiency 81 %
 Peak intensity 1.200 cd/lm
 LEDs/each optic 1
 Light colour White
 Required components:
 C13761_PF-SOCKET-CXA15
 C13723_MIRELLA-RZL

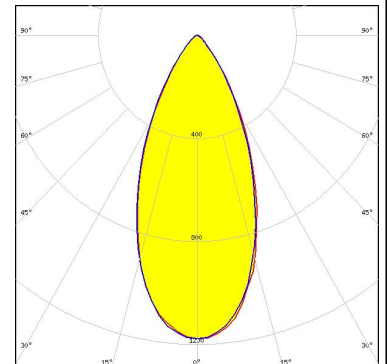
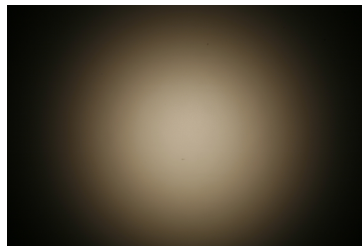

PHOTOMETRIC DATA (MEASURED):



LED CXA/B 15xx
 FWHM 41.0°
 Efficiency 90 %
 Peak intensity 1.400 cd/lm
 LEDs/each optic 1
 Light colour White
 Required components:
 C13761_PF-SOCKET-CXA15

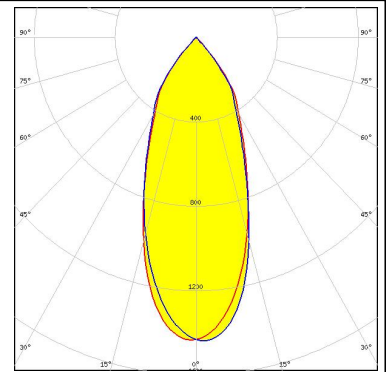

LED CXA/B 15xx
 FWHM 47.0°
 Efficiency 85 %
 Peak intensity 1.200 cd/lm
 LEDs/each optic 1
 Light colour White
 Required components:
 C13761_PF-SOCKET-CXA15
 C12479_MIRELLA-DL

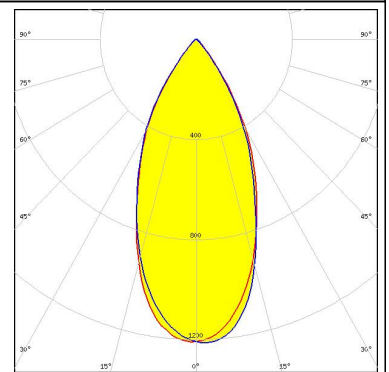

LED CXA/B 15xx
 FWHM 37.0°
 Efficiency 79 %
 Peak intensity 1.600 cd/lm
 LEDs/each optic 1
 Light colour White
 Required components:
 C13709_PF-SOCKET-VERO13-18
 C13333_MIRELLA-CL
 Bender Wirth: 441 Typ L1

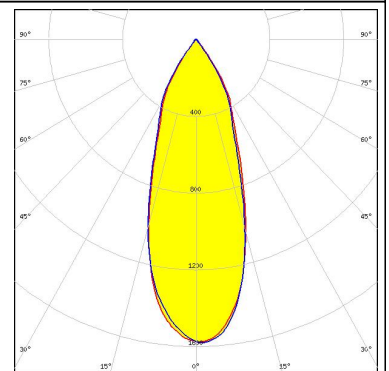
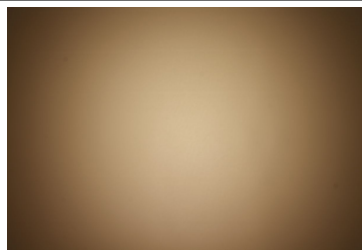

LED CXA/B 15xx
 FWHM 39.0°
 Efficiency 75 %
 Peak intensity 1.300 cd/lm
 LEDs/each optic 1
 Light colour White
 Required components:
 C13709_PF-SOCKET-VERO13-18
 C12479_MIRELLA-DL
 Bender Wirth: 441 Typ L1

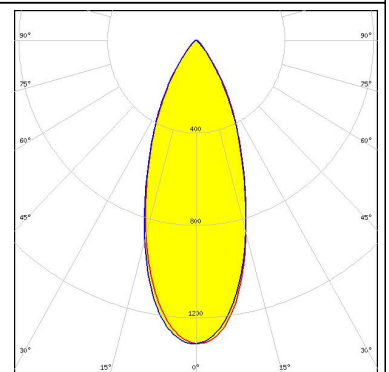
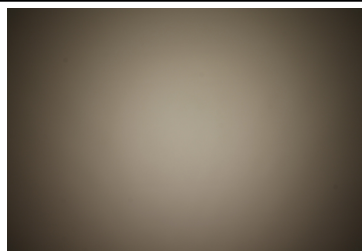

PHOTOMETRIC DATA (MEASURED):



LED CXA/B 1816 & CXA/B 1820 & CXA 1850
 FWHM 45.0°
 Efficiency 84 %
 Peak intensity 1.300 cd/lm
 LEDs/each optic 1
 Light colour White
 Required components:
 C14115_PF-SOCKET-CXA15-18

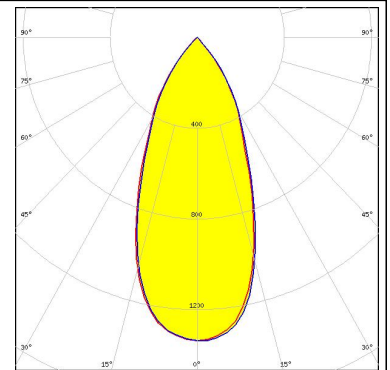
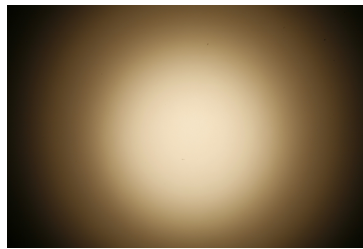

LED CXA/B 1816 & CXA/B 1820 & CXA 1850
 FWHM 43.0°
 Efficiency 87 %
 Peak intensity 1.370 cd/lm
 LEDs/each optic 1
 Light colour White
 Required components:
 IDEAL: 50-2101CR + 50-2100MR

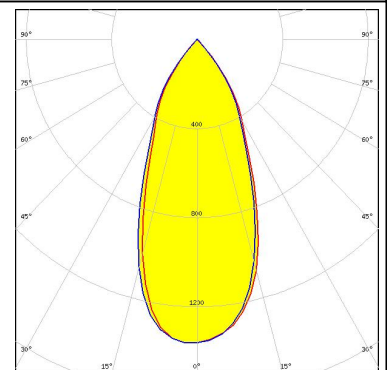
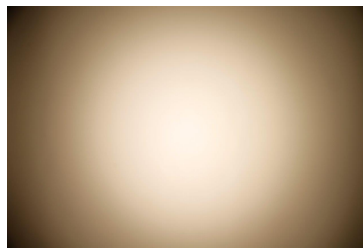

LED MHD-E/G
 FWHM 38.0°
 Efficiency 89 %
 Peak intensity 1.500 cd/lm
 LEDs/each optic 1
 Light colour White
 Required components:
 C13083_PF-SOCKET

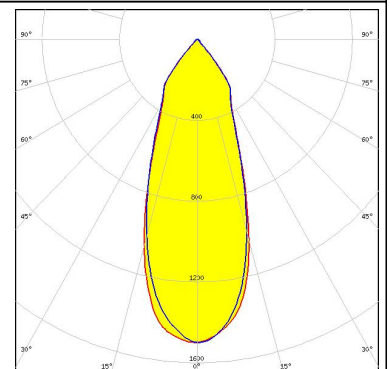
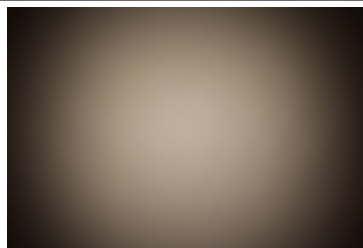

LED MHD-E/G
 FWHM 44.0°
 Efficiency 84 %
 Peak intensity 1.300 cd/lm
 LEDs/each optic 1
 Light colour White
 Required components:
 C13083_PF-SOCKET
 C13333_MIRELLA-CL

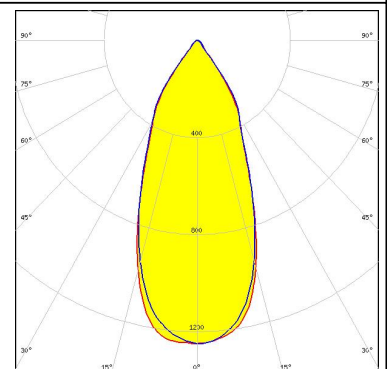
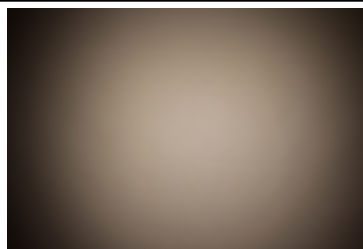

PHOTOMETRIC DATA (MEASURED):



LED MHD-E/G
 FWHM 45.0°
 Efficiency 82 %
 Peak intensity 1.100 cd/lm
 LEDs/each optic 1
 Light colour White
 Required components:
 C13083_PF-SOCKET
 C13723_MIRELLA-RZL

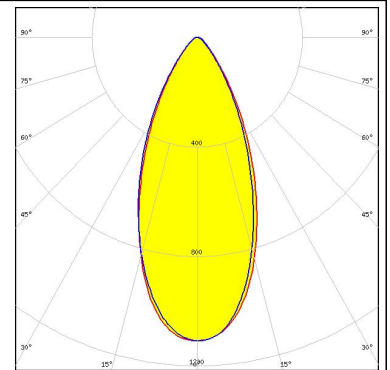
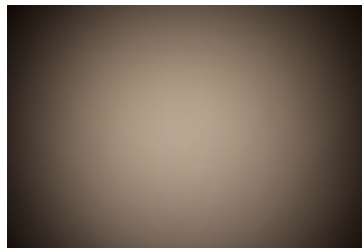

LED MHD-E/G
 FWHM 45.0°
 Efficiency 84 %
 Peak intensity 1.200 cd/lm
 LEDs/each optic 1
 Light colour White
 Required components:
 C13083_PF-SOCKET
 C12479_MIRELLA-DL

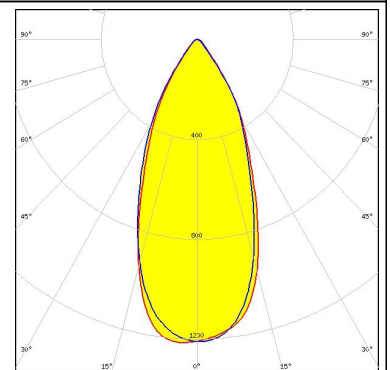
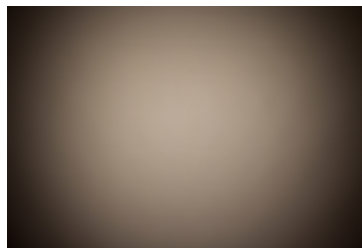

LED MK-R
 FWHM 34.0°
 Efficiency 80 %
 Peak intensity 1.660 cd/lm
 LEDs/each optic 1
 Light colour White
 Required components:
 C13083_PF-SOCKET
 C12479_MIRELLA-DL

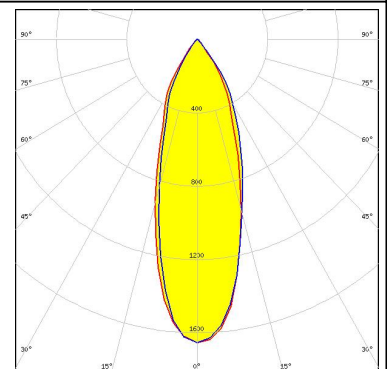
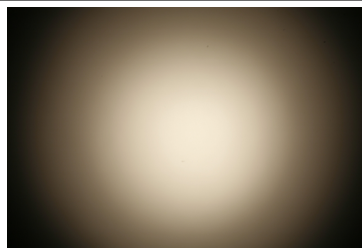

LED MK-R
 FWHM 30.0°
 Efficiency 85 %
 Peak intensity 2.100 cd/lm
 LEDs/each optic 1
 Light colour White
 Required components:
 C13083_PF-SOCKET

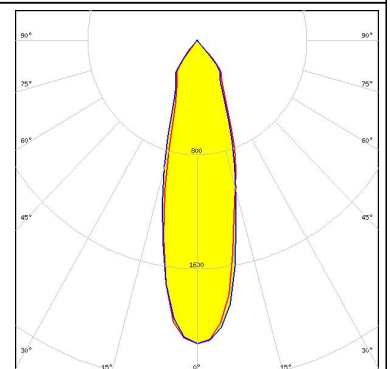
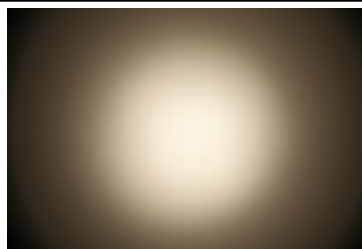

PHOTOMETRIC DATA (MEASURED):

CREE

LED MT-G
FWHM 52.0°
Efficiency 86 %
Peak intensity 1.200 cd/lm
LEDs/each optic 1
Light colour White
Required components:
C13083_PF-SOCKET
C12479_MIRELLA-DL



CREE

LED MT-G
FWHM 52.0°
Efficiency 86 %
Peak intensity 1.200 cd/lm
LEDs/each optic 1
Light colour White
Required components:
C13083_PF-SOCKET
C13333_MIRELLA-CL

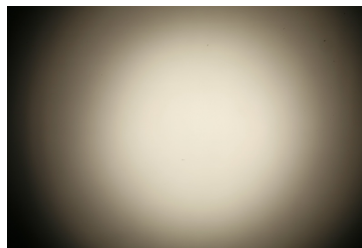

CREE

LED MT-G
FWHM 48.0°
Efficiency 90 %
Peak intensity 1.400 cd/lm
LEDs/each optic 1
Light colour White
Required components:
C13083_PF-SOCKET

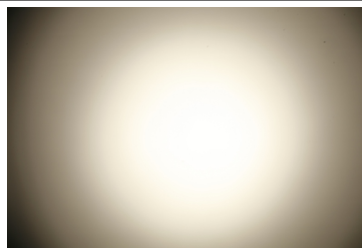

CREE

LED MT-G2
FWHM 50.0°
Efficiency 87 %
Peak intensity 1.200 cd/lm
LEDs/each optic 1
Light colour White
Required components:
C13083_PF-SOCKET
C13333_MIRELLA-CL

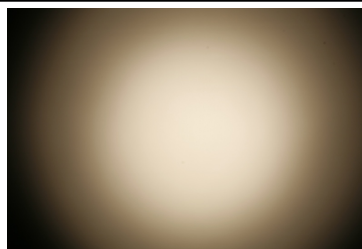

PHOTOMETRIC DATA (MEASURED):

CREE

LED MT-G2
 FWHM 46.0°
 Efficiency 91 %
 Peak intensity 0.800 cd/lm
 LEDs/each optic 1
 Light colour White
 Required components:
 C13083_PF-SOCKET



CREE

LED MT-G2
 FWHM 51.0°
 Efficiency 87 %
 Peak intensity 1.200 cd/lm
 LEDs/each optic 1
 Light colour White
 Required components:
 C13083_PF-SOCKET
 C12479_MIRELLA-DL

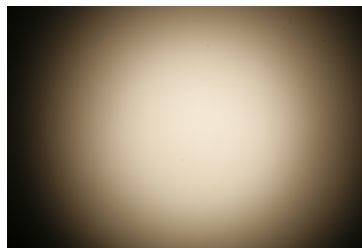

CREE

LED XHP50
 FWHM 39.0°
 Efficiency 81 %
 Peak intensity 1.500 cd/lm
 LEDs/each optic 1
 Light colour White
 Required components:
 C13083_PF-SOCKET
 C13333_MIRELLA-CL

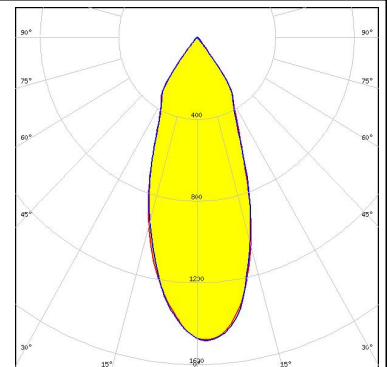
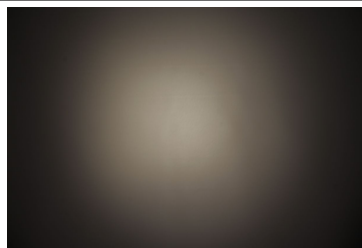

CREE

LED XHP50
 FWHM 38.0°
 Efficiency 80 %
 Peak intensity 1.300 cd/lm
 LEDs/each optic 1
 Light colour White
 Required components:
 C13083_PF-SOCKET
 C13723_MIRELLA-RZL

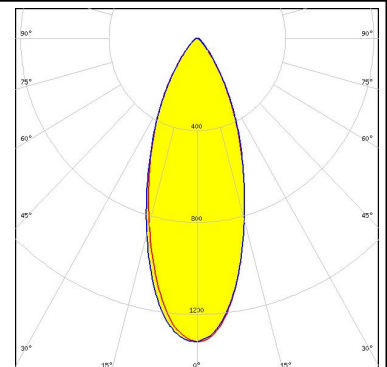
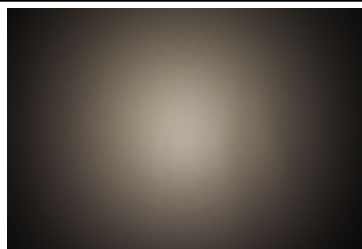

PHOTOMETRIC DATA (MEASURED):

CREE 

LED XHP50
 FWHM 39.0°
 Efficiency 82 %
 Peak intensity 1.400 cd/lm
 LEDs/each optic 1
 Light colour White
 Required components:
 C13083_PF-SOCKET
 C12479_MIRELLA-DL

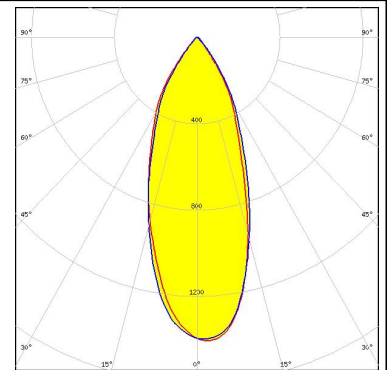
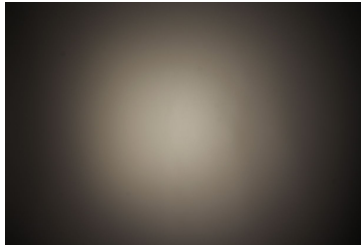

CREE 

LED XHP50
 FWHM 33.0°
 Efficiency 87 %
 Peak intensity 1.800 cd/lm
 LEDs/each optic 1
 Light colour White
 Required components:
 C13083_PF-SOCKET

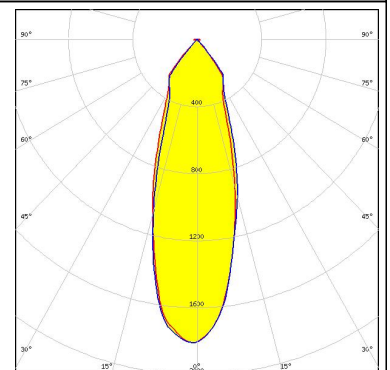
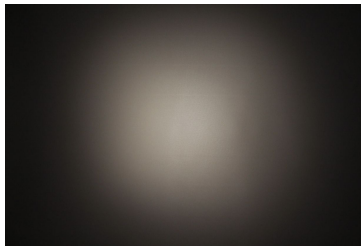

CREE 

LED XHP70
 FWHM 39.0°
 Efficiency 86 %
 Peak intensity 1.500 cd/lm
 LEDs/each optic 1
 Light colour White
 Required components:
 C13083_PF-SOCKET

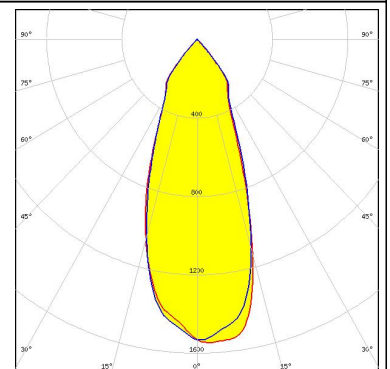
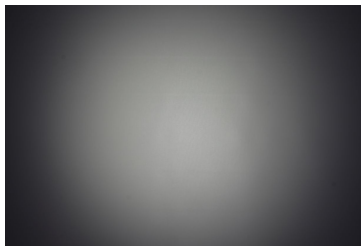

CREE 

LED XHP70
 FWHM 43.0°
 Efficiency 81 %
 Peak intensity 1.300 cd/lm
 LEDs/each optic 1
 Light colour White
 Required components:
 C13083_PF-SOCKET
 C12479_MIRELLA-DL

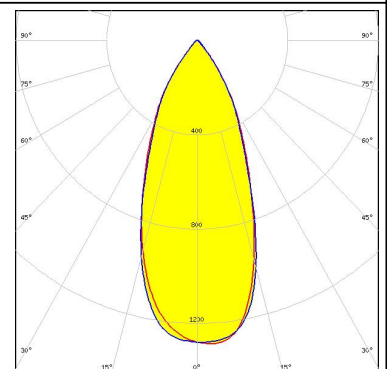
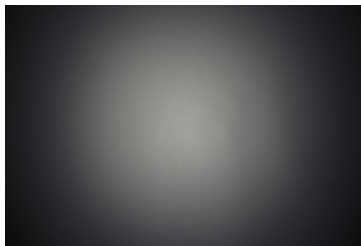

PHOTOMETRIC DATA (MEASURED):



LED XHP70
 FWHM 42.0°
 Efficiency 81 %
 Peak intensity 1.300 cd/lm
 LEDs/each optic 1
 Light colour White
 Required components:
 C13083_PF-SOCKET
 C13333_MIRELLA-CL

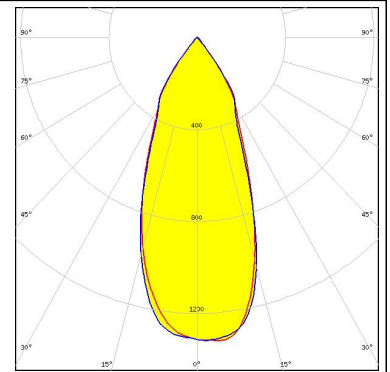
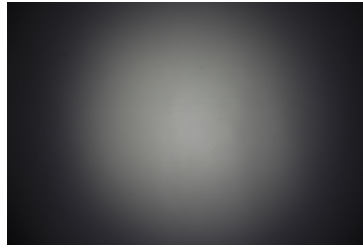

LED XHP70
 FWHM 44.0°
 Efficiency 79 %
 Peak intensity 1.200 cd/lm
 LEDs/each optic 1
 Light colour White
 Required components:
 C13083_PF-SOCKET
 C13723_MIRELLA-RZL

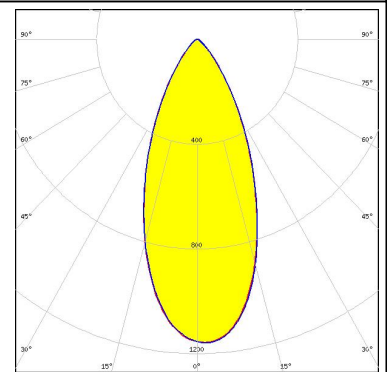
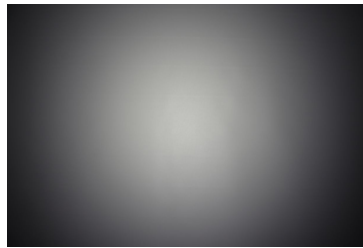

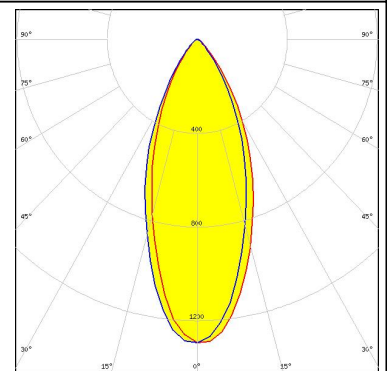
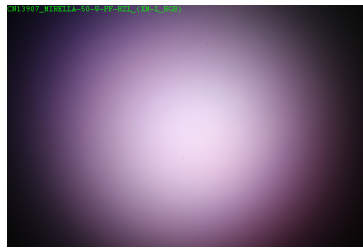

LED XM-L RGB
 FWHM 41.0°
 Efficiency 80 %
 Peak intensity 1.300 cd/lm
 LEDs/each optic 1
 Light colour White
 Required components:
 C13083_PF-SOCKET
 C13723_MIRELLA-RZL



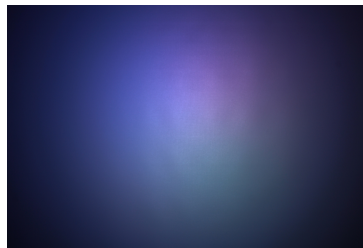

LED XQ-E HI
 FWHM 42.0°
 Efficiency 87 %
 Peak intensity 1.380 cd/lm
 LEDs/each optic 4
 Light colour RGBW
 Required components:
 C13083_PF-SOCKET
 C13723_MIRELLA-RZL

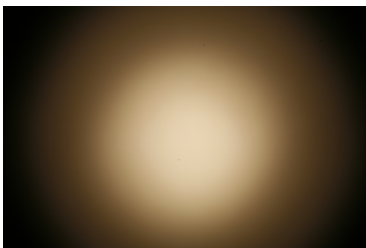

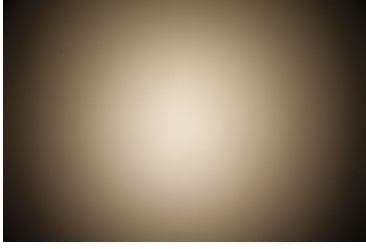
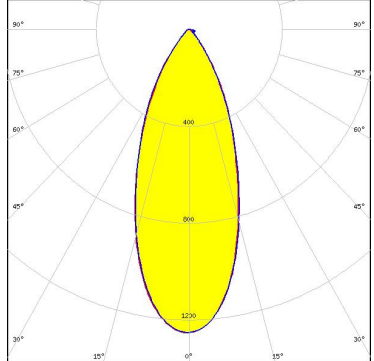

PHOTOMETRIC DATA (MEASURED):

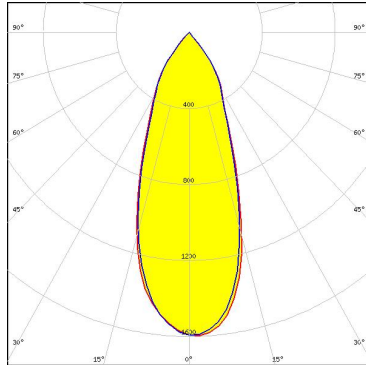
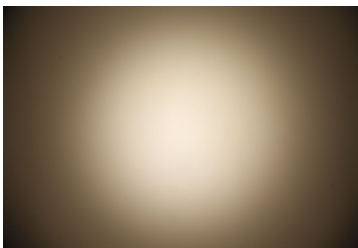
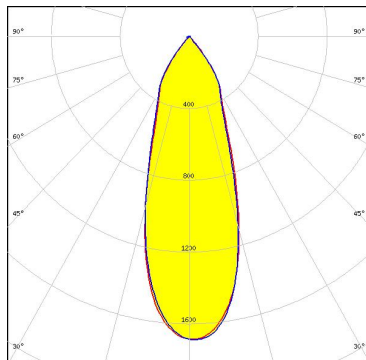
<p>LG Innotek</p> <p>LED COB 4W FWHM 38.0° Efficiency 89 % Peak intensity 1.700 cd/lm LEDs/each optic 1 Light colour White Required components: C13083_PF-SOCKET</p>	
<p>LG Innotek</p> <p>LED COB 4W FWHM 40.0° Efficiency 83 % Peak intensity 1.600 cd/lm LEDs/each optic 1 Light colour White Required components: C13083_PF-SOCKET C13333_MIRELLA-CL</p>	
<p>LG Innotek</p> <p>LED COB 4W FWHM 44.0° Efficiency 83 % Peak intensity 1.400 cd/lm LEDs/each optic 1 Light colour White Required components: C13083_PF-SOCKET C12479_MIRELLA-DL</p>	
<p>LUMILEDS</p> <p>LED LUXEON CoB 1202/1203 FWHM 40.0° Efficiency 75 % Peak intensity 1.300 cd/lm LEDs/each optic 1 Light colour White Required components: C13709_PF-SOCKET-VERO13-18 C12479_MIRELLA-DL Bender Wirth: 438 Typ L1</p>	 

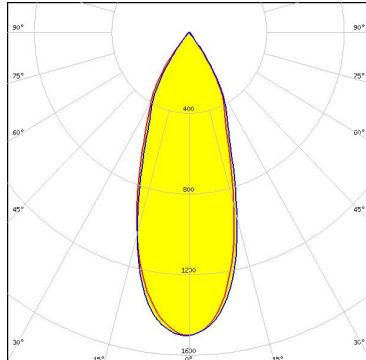
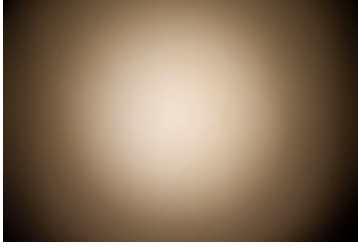
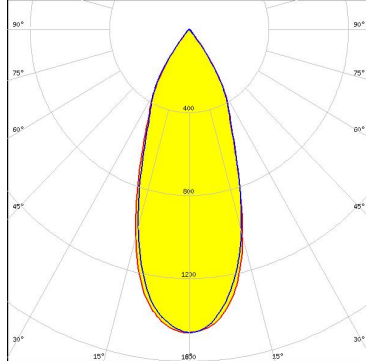
PHOTOMETRIC DATA (MEASURED):

<p>LUMILEDS</p> <p>LED LUXEON CoB 1202/1203 FWHM 39.0° Efficiency 86 % Peak intensity 1.600 cd/lm LEDs/each optic 1 Light colour White Required components: C14037_PF-NSX-SOCKET</p>		
<p>LUMILEDS</p> <p>LED LUXEON CoB 1202/1203 FWHM 35.0° Efficiency 83 % Peak intensity 1.700 cd/lm LEDs/each optic 1 Light colour White Required components: C13709_PF-SOCKET-VERO13-18 Bender Wirth: 438 Typ L1</p>		
<p>LUMILEDS</p> <p>LED LUXEON CoB 1202/1203 FWHM 37.0° Efficiency 77 % Peak intensity 1.500 cd/lm LEDs/each optic 1 Light colour White Required components: C13709_PF-SOCKET-VERO13-18 C13333_MIRELLA-CL Bender Wirth: 438 Typ L1</p>		
<p>LUMILEDS</p> <p>LED LUXEON CoB 1202/1203 FWHM 39.0° Efficiency 80 % Peak intensity 1.500 cd/lm LEDs/each optic 1 Light colour White Required components: C13333_MIRELLA-CL IDEAL: 50-2100NC +50-2100MR</p>		

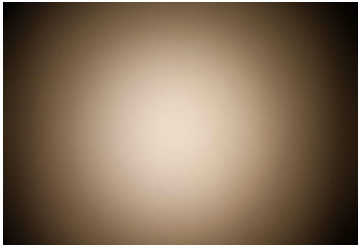
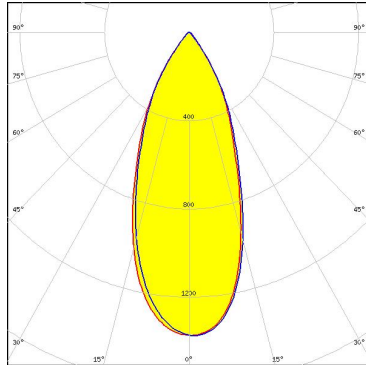
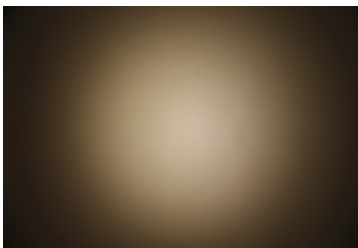
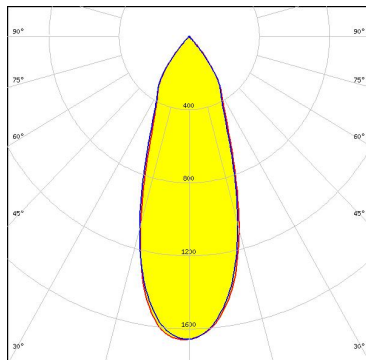
PHOTOMETRIC DATA (MEASURED):

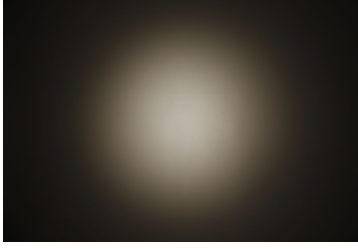
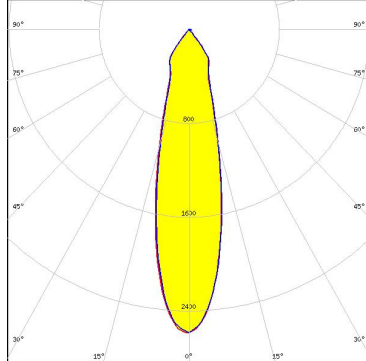
<p>LUMILEDS</p> <p>LED LUXEON CoB 1202/1203 FWHM 41.0° Efficiency 81 % Peak intensity 1.400 cd/lm LEDs/each optic 1 Light colour White Required components: C12479_MIRELLA-DL IDEAL: 50-2100NC +50-2100MR</p>		
<p>LUMILEDS</p> <p>LED LUXEON CoB 1202/1203 FWHM 37.0° Efficiency 87 % Peak intensity 1.700 cd/lm LEDs/each optic 1 Light colour White Required components: IDEAL: 50-2100NC +50-2100MR</p>		
<p>LUMILEDS</p> <p>LED LUXEON CoB 1202s FWHM 35.0° Efficiency 88 % Peak intensity 1.900 cd/lm LEDs/each optic 1 Light colour White Required components: C13761_PF-SOCKET-CXA15</p>		
<p>LUMILEDS</p> <p>LED LUXEON CoB 1202s FWHM 25.0° Efficiency 85 % Peak intensity 2.600 cd/lm LEDs/each optic 1 Light colour White Required components: C13709_PF-SOCKET-VERO13-18 Bender Wirth: 452 Typ L1</p>		

PHOTOMETRIC DATA (MEASURED):

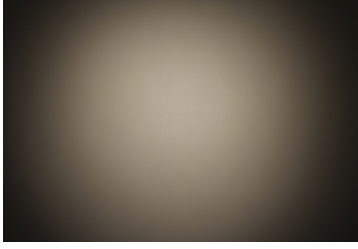
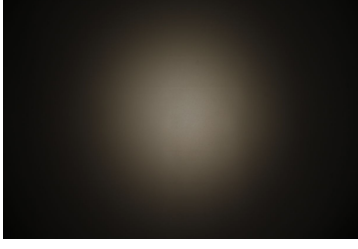
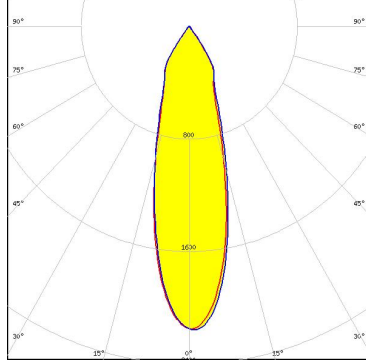
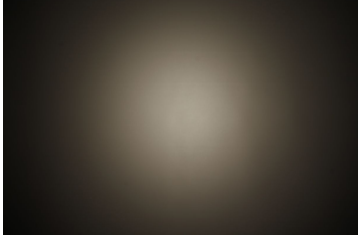
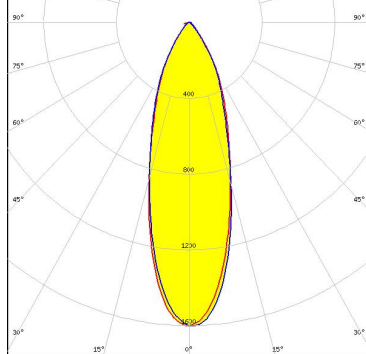
<p>LUMILEDS</p> <p>LED LUXEON CoB 1202s FWHM 40.0° Efficiency 82 % Peak intensity 1.500 cd/lm LEDs/each optic 1 Light colour White</p> <p>Required components: C13761_PF-SOCKET-CXA15 C12479_MIRELLA-DL</p>		
<p>LUMILEDS</p> <p>LED LUXEON CoB 1202s FWHM 41.0° Efficiency 82 % Peak intensity 1.500 cd/lm LEDs/each optic 1 Light colour White</p> <p>Required components: C13761_PF-SOCKET-CXA15 C13333_MIRELLA-CL</p>		
<p>LUMILEDS</p> <p>LED LUXEON CoB 1202s FWHM 28.0° Efficiency 81 % Peak intensity 2.200 cd/lm LEDs/each optic 1 Light colour White</p> <p>Required components: C13709_PF-SOCKET-VERO13-18 C13333_MIRELLA-CL Bender Wirth: 452 Typ L1</p>		
<p>LUMILEDS</p> <p>LED LUXEON CoB 1202s FWHM 32.0° Efficiency 77 % Peak intensity 1.600 cd/lm LEDs/each optic 1 Light colour White</p> <p>Required components: C13709_PF-SOCKET-VERO13-18 C12479_MIRELLA-DL Bender Wirth: 452 Typ L1</p>		

PHOTOMETRIC DATA (MEASURED):



LED LUXEON Z
 FWHM 36.0°
 Efficiency 79 %
 Peak intensity 1.500 cd/lm
 LEDs/each optic 4
 Light colour RGBW
 Required components:
 C13083_PF-SOCKET
 C13723_MIRELLA-RZL

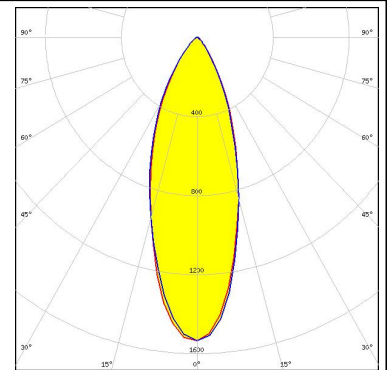

LED CXM-6
 FWHM 36.0°
 Efficiency 85 %
 Peak intensity 1.800 cd/lm
 LEDs/each optic 1
 Light colour White
 Required components:
 C13083_PF-SOCKET

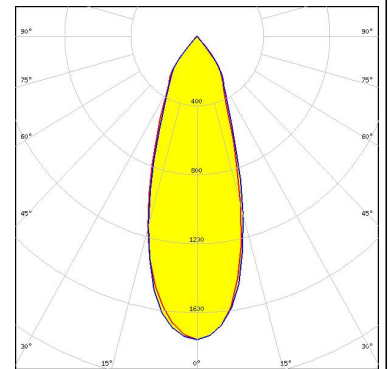

LED CXM-7
 FWHM 38.0°
 Efficiency 86 %
 Peak intensity 1.600 cd/lm
 LEDs/each optic 1
 Light colour White
 Required components:
 C13083_PF-SOCKET

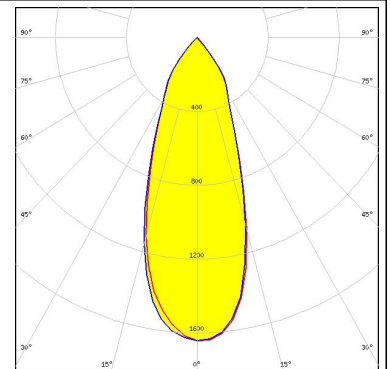

LED CXM-9
 FWHM 44.0°
 Efficiency 88 %
 Peak intensity 1.300 cd/lm
 LEDs/each optic 1
 Light colour White
 Required components:
 C13083_PF-SOCKET

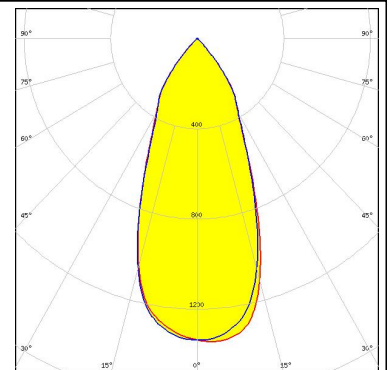
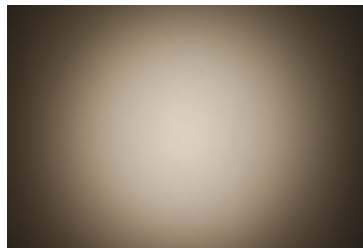

PHOTOMETRIC DATA (MEASURED):



LED CXM-9
 FWHM 48.0°
 Efficiency 83 %
 Peak intensity 1.200 cd/lm
 LEDs/each optic 1
 Light colour White
 Required components:
 C13083_PF-SOCKET
 C13333_MIRELLA-CL

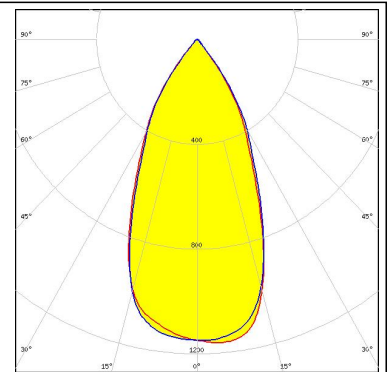
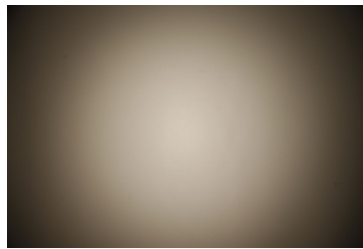

LED CXM-9
 FWHM 48.0°
 Efficiency 80 %
 Peak intensity 1.100 cd/lm
 LEDs/each optic 1
 Light colour White
 Required components:
 C13083_PF-SOCKET
 C13723_MIRELLA-RZL

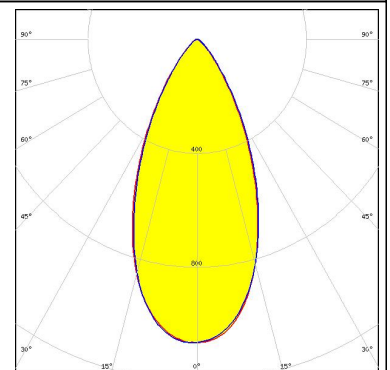
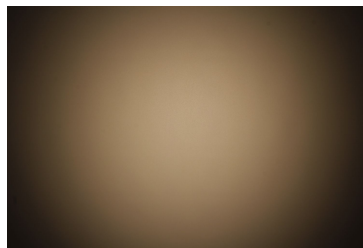

LED CXM-9
 FWHM 49.0°
 Efficiency 83 %
 Peak intensity 1.100 cd/lm
 LEDs/each optic 1
 Light colour White
 Required components:
 C13083_PF-SOCKET
 C12479_MIRELLA-DL

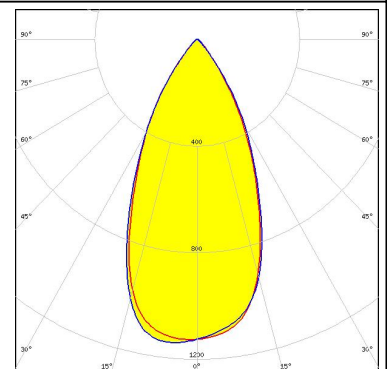
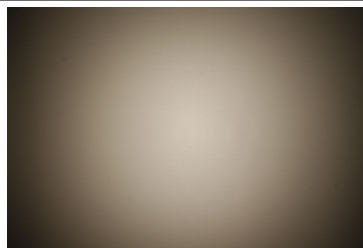

LED COB L-Type (LES 11)
 FWHM 45.0°
 Efficiency 77 %
 Peak intensity 1.200 cd/lm
 LEDs/each optic 1
 Light colour White
 Required components:
 C13709_PF-SOCKET-VERO13-18
 C13333_MIRELLA-CL
 Bender Wirth: 438 Typ L1

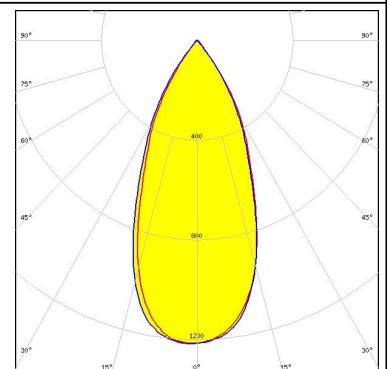
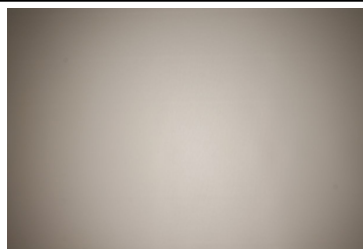

PHOTOMETRIC DATA (MEASURED):



LED COB L-Type (LES 11)
 FWHM 47.0°
 Efficiency 81 %
 Peak intensity 1.200 cd/lm
 LEDs/each optic 1
 Light colour White
 Required components:
 C13333_MIRELLA-CL
 IDEAL: 50-2100NC +50-2100MR

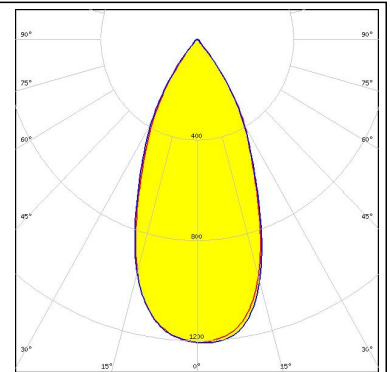

LED COB L-Type (LES 11)
 FWHM 46.0°
 Efficiency 80 %
 Peak intensity 1.200 cd/lm
 LEDs/each optic 1
 Light colour White
 Required components:
 C12479_MIRELLA-DL
 IDEAL: 50-2100NC +50-2100MR

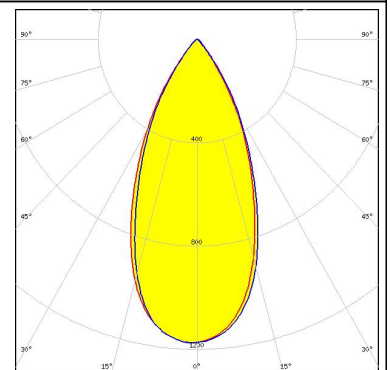
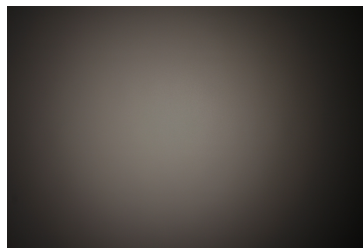

LED COB L-Type (LES 11)
 FWHM 46.0°
 Efficiency 84 %
 Peak intensity 1.260 cd/lm
 LEDs/each optic 1
 Light colour White
 Required components:
 C14037_PF-NSX-SOCKET

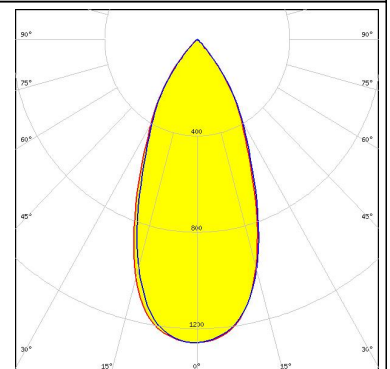
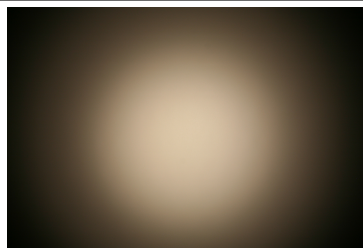

LED COB L-Type (LES 11)
 FWHM 43.0°
 Efficiency 86 %
 Peak intensity 1.400 cd/lm
 LEDs/each optic 1
 Light colour White
 Required components:
 IDEAL: 50-2100NC +50-2100MR

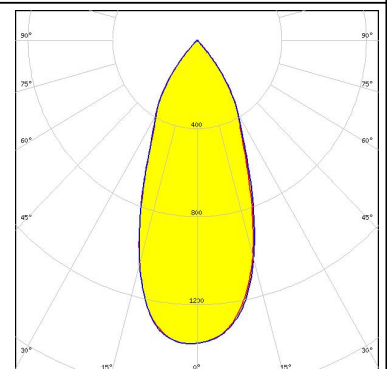
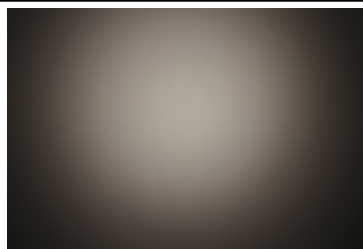

PHOTOMETRIC DATA (MEASURED):



LED COB L-Type (LES 11)
 FWHM 46.0°
 Efficiency 75 %
 Peak intensity 1.100 cd/lm
 LEDs/each optic 1
 Light colour White
 Required components:
 C13709_PF-SOCKET-VERO13-18
 C12479_MIRELLA-DL
 Bender Wirth: 438 Typ L1

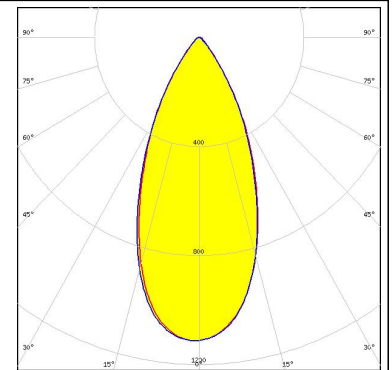
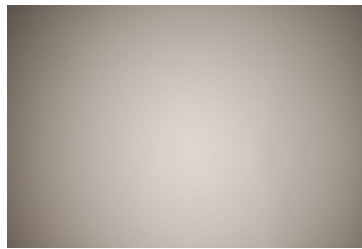

LED COB L-Type (LES 11)
 FWHM 41.0°
 Efficiency 81 %
 Peak intensity 1.400 cd/lm
 LEDs/each optic 1
 Light colour White
 Required components:
 C13709_PF-SOCKET-VERO13-18
 Bender Wirth: 438 Typ L1

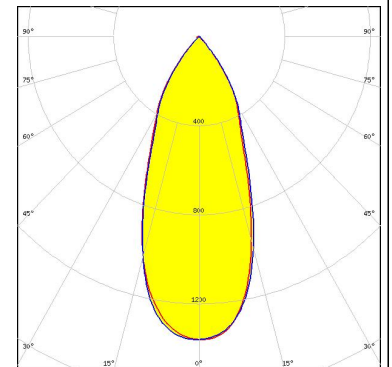

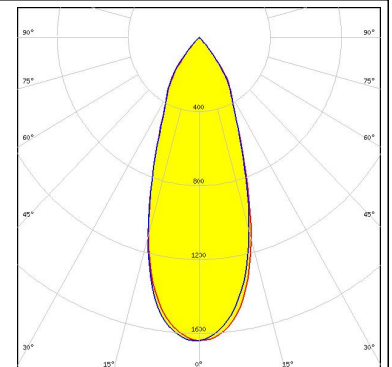

LED COB L-Type (LES 9)
 FWHM 38.0°
 Efficiency 86 %
 Peak intensity 1.640 cd/lm
 LEDs/each optic 1
 Light colour White
 Required components:
 C14037_PF-NSX-SOCKET



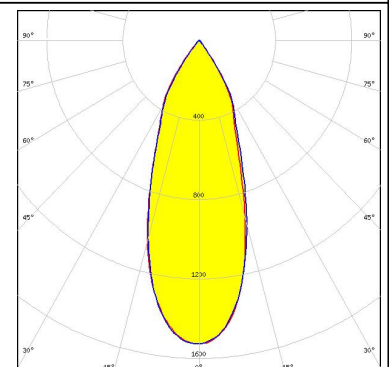
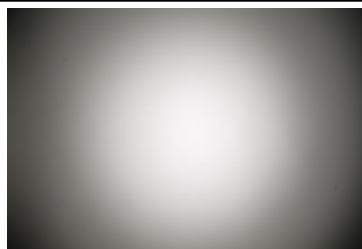

LED COB L-Type (LES 9)
 FWHM 37.0°
 Efficiency 79 %
 Peak intensity 1.500 cd/lm
 LEDs/each optic 1
 Light colour White
 Required components:
 C13709_PF-SOCKET-VERO13-18
 C13333_MIRELLA-CL
 Bender Wirth: 438 Typ L1

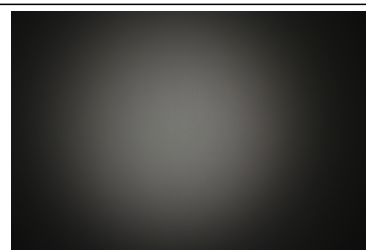
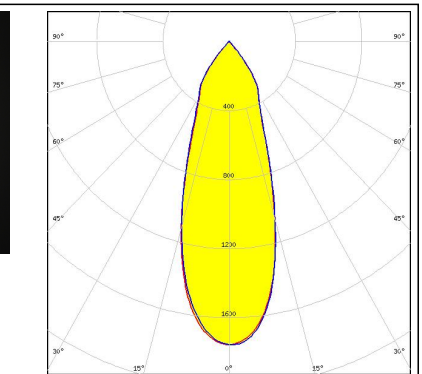
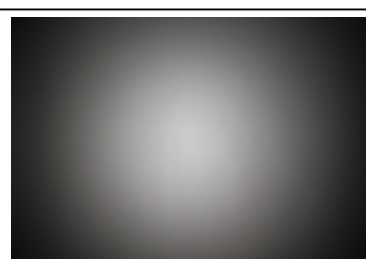
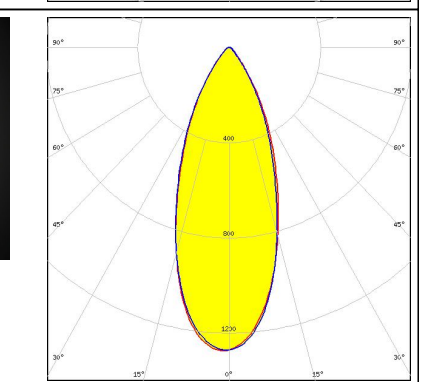
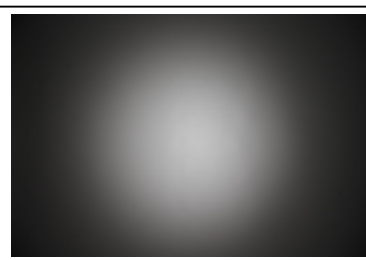
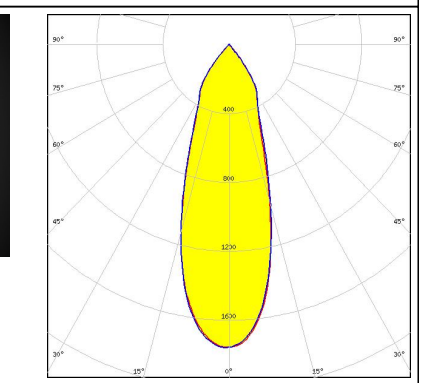

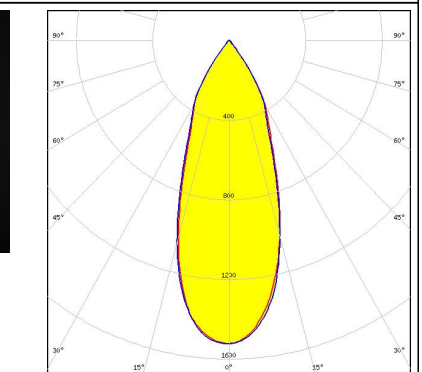

PHOTOMETRIC DATA (MEASURED):

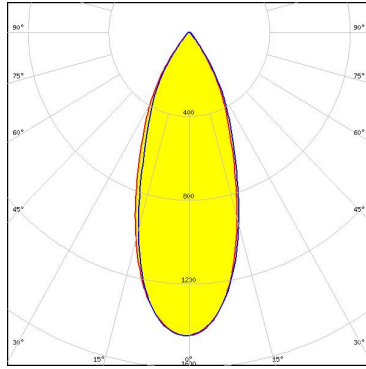
<p>NICHIA</p> <p>LED COB L-Type (LES 9) FWHM 35.0° Efficiency 87 % Peak intensity 1.800 cd/lm LEDs/each optic 1 Light colour White Required components: IDEAL: 50-2100NC +50-2100MR</p>		
<p>NICHIA</p> <p>LED COB L-Type (LES 9) FWHM 40.0° Efficiency 76 % Peak intensity 1.300 cd/lm LEDs/each optic 1 Light colour White Required components: C13709_PF-SOCKET-VERO13-18 C12479_MIRELLA-DL Bender Wirth: 438 Typ L1</p>		
<p>NICHIA</p> <p>LED COB L-Type (LES 9) FWHM 34.0° Efficiency 84 % Peak intensity 1.800 cd/lm LEDs/each optic 1 Light colour White Required components: C13709_PF-SOCKET-VERO13-18 Bender Wirth: 438 Typ L1</p>		
<p>NICHIA</p> <p>LED COB L-Type (LES 9) FWHM 38.0° Efficiency 81 % Peak intensity 1.500 cd/lm LEDs/each optic 1 Light colour White Required components: C13333_MIRELLA-CL IDEAL: 50-2100NC +50-2100MR</p>		

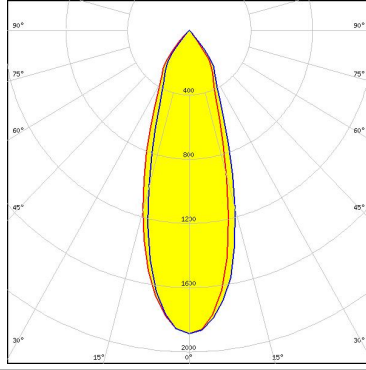
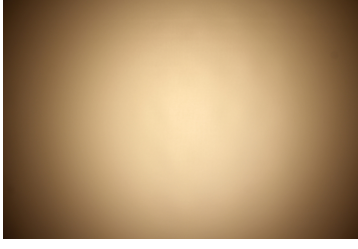
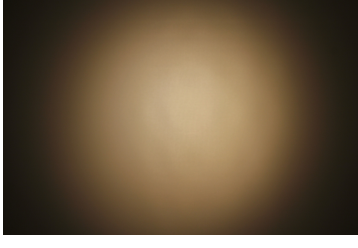



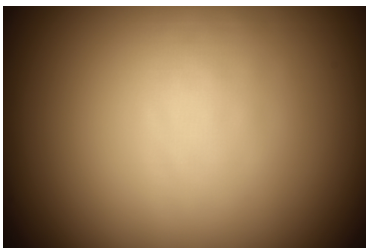

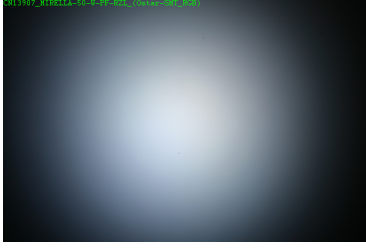
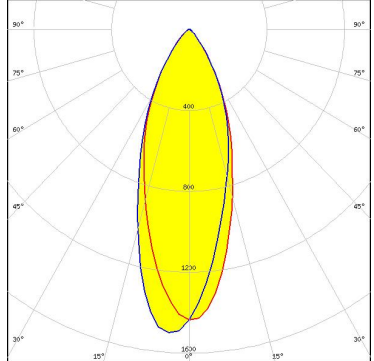
PHOTOMETRIC DATA (MEASURED):

<p>NICHIA</p> <p>LED COB L-Type (LES 9)</p> <p>FWHM 39.0°</p> <p>Efficiency 80 %</p> <p>Peak intensity 1.400 cd/lm</p> <p>LEDs/each optic 1</p> <p>Light colour White</p> <p>Required components: C12479_MIRELLA-DL IDEAL: 50-2100NC +50-2100MR</p>		
<p>NICHIA</p> <p>LED NSCxL036A</p> <p>FWHM 34.0°</p> <p>Efficiency 85 %</p> <p>Peak intensity 1.880 cd/lm</p> <p>LEDs/each optic 1</p> <p>Light colour White</p> <p>Required components: C14037_PF-NSX-SOCKET</p>		
<p>OSRAM Opto Semiconductors</p> <p>LED Duris S10</p> <p>FWHM 45.0°</p> <p>Efficiency 79 %</p> <p>Peak intensity 1.300 cd/lm</p> <p>LEDs/each optic 1</p> <p>Light colour White</p> <p>Required components: C13083_PF-SOCKET C12479_MIRELLA-DL</p>		
<p>OSRAM Opto Semiconductors</p> <p>LED Duris S10</p> <p>FWHM 38.0°</p> <p>Efficiency 87 %</p> <p>Peak intensity 1.700 cd/lm</p> <p>LEDs/each optic 1</p> <p>Light colour White</p> <p>Required components: C13083_PF-SOCKET</p>		

PHOTOMETRIC DATA (MEASURED):

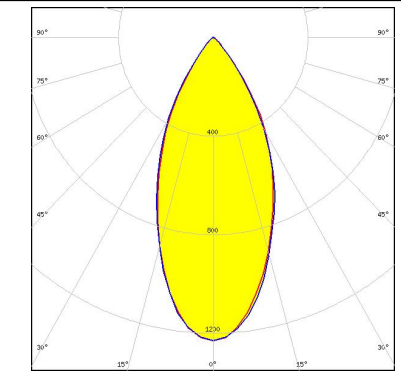
<p>OSRAM Opto Semiconductors</p> <p>LED Duris S10 FWHM 43.0° Efficiency % Peak intensity cd/lm LEDs/each optic 1 Light colour White Required components: C13083_PF-SOCKET C13333_MIRELLA-CL</p>	
<p>OSRAM Opto Semiconductors</p> <p>LED Duris S10 FWHM 45.0° Efficiency 80 % Peak intensity 1.300 cd/lm LEDs/each optic 1 Light colour White Required components: C13083_PF-SOCKET C13723_MIRELLA-RZL</p>	
<p>OSRAM Opto Semiconductors</p> <p>LED OSTAR Stage (S2WP) FWHM 36.0° Efficiency 83 % Peak intensity 1.600 cd/lm LEDs/each optic 1 Light colour White Required components: C13083_PF-SOCKET C13723_MIRELLA-RZL</p>	
<p>OSRAM Opto Semiconductors</p> <p>LED Ostar-SMT RGB FWHM 37.0° Efficiency 81 % Peak intensity 1.500 cd/lm LEDs/each optic 1 Light colour White Required components: C13083_PF-SOCKET C13723_MIRELLA-RZL</p>	 

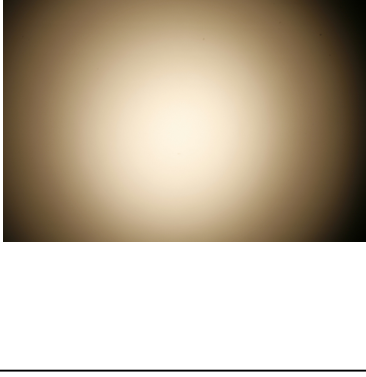
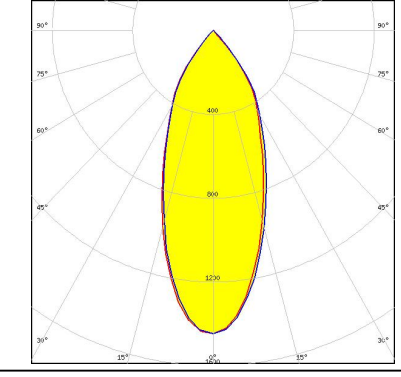
PHOTOMETRIC DATA (MEASURED):

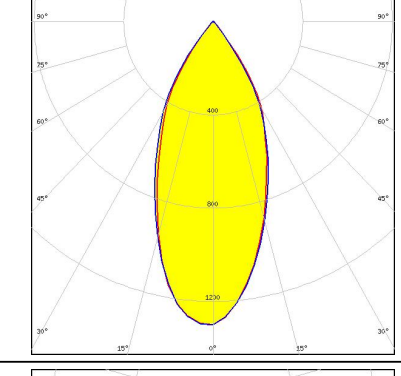
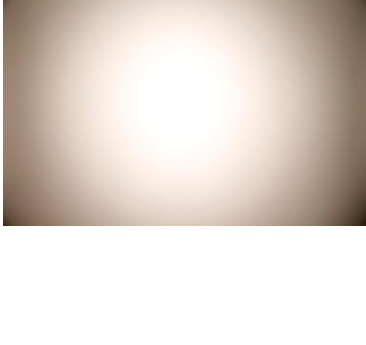
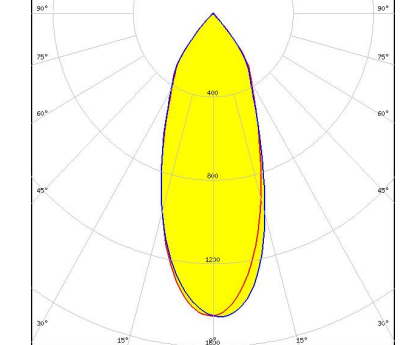
<p> SEOL SEMICONDUCTOR</p> <p>LED ZC4/6 FWHM 48.0° Efficiency 81 % Peak intensity 1.200 cd/lm LEDs/each optic 1 Light colour White Required components: C13083_PF-SOCKET C12479_MIRELLA-DL</p>		
<p> SEOL SEMICONDUCTOR</p> <p>LED ZC4/6 FWHM 42.0° Efficiency 86 % Peak intensity 1.400 cd/lm LEDs/each optic 1 Light colour White Required components: C13083_PF-SOCKET</p>		
<p> SEOL SEMICONDUCTOR</p> <p>LED ZC4/6 FWHM 46.0° Efficiency 80 % Peak intensity 1.300 cd/lm LEDs/each optic 1 Light colour White Required components: C13083_PF-SOCKET C13333_MIRELLA-CL</p>		
<p>SHARP</p> <p>LED Mini Zenigata (GW6BM) FWHM 38.0° Efficiency 88 % Peak intensity 1.500 cd/lm LEDs/each optic 1 Light colour White Required components: C13083_PF-SOCKET</p>		

PHOTOMETRIC DATA (MEASURED):

SHARP

LED Mini Zenigata (GW6BM)
 FWHM 45.0°
 Efficiency 81 %
 Peak intensity 1.100 cd/lm
 LEDs/each optic 1
 Light colour White
 Required components:
 C13083_PF-SOCKET
 C12479_MIRELLA-DL

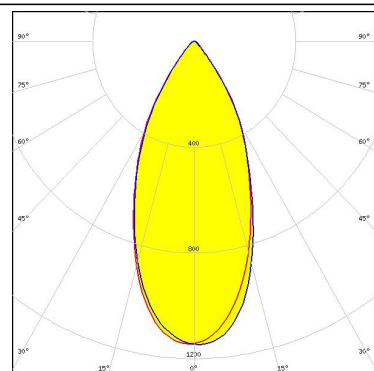
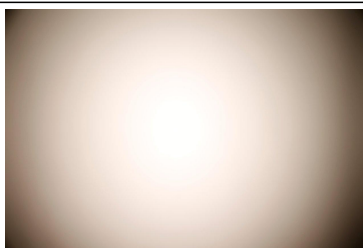

SHARP

LED Mini Zenigata (GW6BM)
 FWHM 46.0°
 Efficiency 81 %
 Peak intensity 1.300 cd/lm
 LEDs/each optic 1
 Light colour White
 Required components:
 C13083_PF-SOCKET
 C13333_MIRELLA-CL

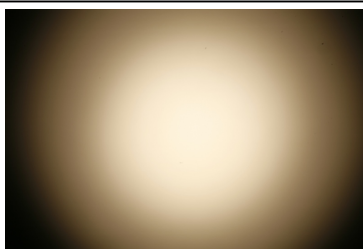

TRIDONIC

LED SLE G5 LES11
 FWHM 45.0°
 Efficiency 87 %
 Peak intensity 1.320 cd/lm
 LEDs/each optic 1
 Light colour White
 Required components:
 C13083_PF-SOCKET

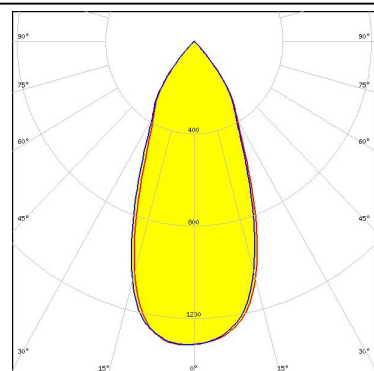
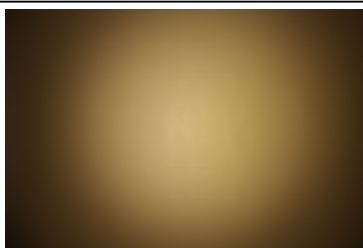

TRIDONIC

LED SLE G5 LES6
 FWHM 35.0°
 Efficiency 88 %
 Peak intensity 1.760 cd/lm
 LEDs/each optic 1
 Light colour White
 Required components:
 C13083_PF-SOCKET

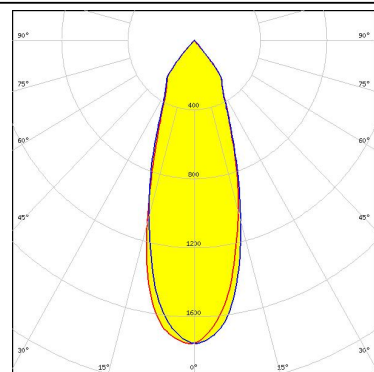
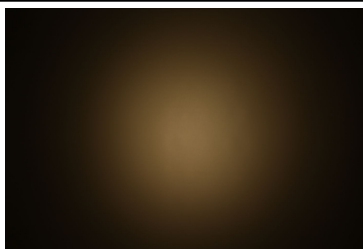

PHOTOMETRIC DATA (MEASURED):

XICATO

LED XTM - 9mm LES
FWHM 35.0°
Efficiency 83 %
Peak intensity 1.700 cd/lm
LEDs/each optic 1
Light colour White
Required components:
C14636_XTM-PF-ADAPTER

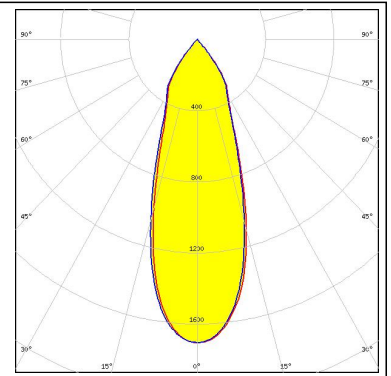
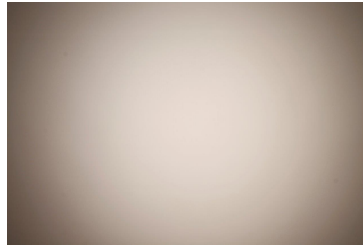

PHOTOMETRIC DATA (SIMULATED):

LUMILEDS

LED LUXEON CoB Compact
FWHM 40.0°
Efficiency 82 %
Peak intensity 1.500 cd/lm
LEDs/each optic 1
Light colour White
Required components:
C13761_PF-SOCKET-CXA15
C12479_MIRELLA-DL

LUMILEDS

LED LUXEON CoB Compact
FWHM 32.0°
Efficiency 77 %
Peak intensity 1.600 cd/lm
LEDs/each optic 1
Light colour White
Required components:
C13709_PF-SOCKET-VERO13-18
C12479_MIRELLA-DL
Bender Wirth: 452 Typ L1

LUMILEDS

LED LUXEON CoB Compact
FWHM 37.0°
Efficiency 77 %
Peak intensity 1.500 cd/lm
LEDs/each optic 1
Light colour White
Required components:
C13709_PF-SOCKET-VERO13-18
C13333_MIRELLA-CL
Bender Wirth: 452 Typ L1

LUMILEDS

LED LUXEON CoB Compact
FWHM 25.0°
Efficiency 85 %
Peak intensity 2.600 cd/lm
LEDs/each optic 1
Light colour White
Required components:
C13709_PF-SOCKET-VERO13-18
Bender Wirth: 452 Typ L1

PHOTOMETRIC DATA (SIMULATED):

LUMILEDS

LED LUXEON CoB Compact
FWHM 41.0°
Efficiency 82 %
Peak intensity 1.500 cd/lm
LEDs/each optic 1
Light colour White
Required components:
C13761_PF-SOCKET-CXA15
C13333_MIRELLA-CL

LUMILEDS

LED LUXEON CoB Compact
FWHM 35.0°
Efficiency 88 %
Peak intensity 1.900 cd/lm
LEDs/each optic 1
Light colour White
Required components:
C13761_PF-SOCKET-CXA15

LUMILEDS

LED LUXEON K4
FWHM 46.0°
Efficiency 88 %
Peak intensity 1.260 cd/lm
LEDs/each optic 1
Light colour White
Required components:
C13761_PF-SOCKET-CXA15

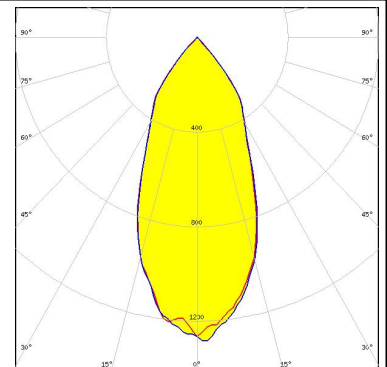

LUMILEDS

LED LUXEON K4
FWHM 54.0°
Efficiency 83 %
Peak intensity 0.870 cd/lm
LEDs/each optic 1
Light colour White
Required components:
C13761_PF-SOCKET-CXA15
C12479_MIRELLA-DL

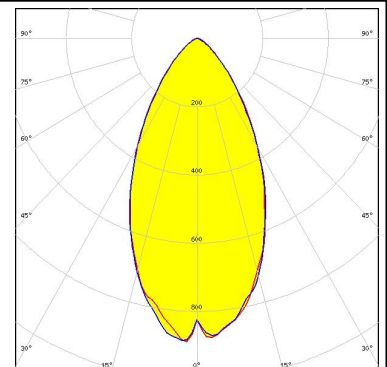

PHOTOMETRIC DATA (SIMULATED):

LUMINUS

LED CXM-14
FWHM 51.0°
Efficiency 70 %
Peak intensity 0.900 cd/lm
LEDs/each optic 1
Light colour White
Required components:
C13709_PF-SOCKET-VERO13-18
C12479_MIRELLA-DL
Bender Wirth: 433 Typ L1

LUMINUS

LED CXM-14
FWHM 49.0°
Efficiency 75 %
Peak intensity 1.000 cd/lm
LEDs/each optic 1
Light colour White
Required components:
C13709_PF-SOCKET-VERO13-18
Bender Wirth: 433 Typ L1

LUMINUS

LED CXM-9
FWHM 36.0°
Efficiency 84 %
Peak intensity 1.700 cd/lm
LEDs/each optic 1
Light colour White
Required components:
C13709_PF-SOCKET-VERO13-18
Bender Wirth: 434 Typ L1

LUMINUS

LED CXM-9
FWHM 39.0°
Efficiency 78 %
Peak intensity 1.500 cd/lm
LEDs/each optic 1
Light colour White
Required components:
C13709_PF-SOCKET-VERO13-18
C13333_MIRELLA-CL
Bender Wirth: 434 Typ L1

PHOTOMETRIC DATA (SIMULATED):



LED CXM-9
FWHM 41.0°
Efficiency 76 %
Peak intensity 1.300 cd/lm
LEDs/each optic 1
Light colour White
Required components:
C13709_PF-SOCKET-VERO13-18
C12479_MIRELLA-DL
Bender Wirth: 434 Typ L1



LED COB S-Type (LES 7)
FWHM 25.0°
Efficiency 85 %
Peak intensity 2.600 cd/lm
LEDs/each optic 1
Light colour White
Required components:
C13709_PF-SOCKET-VERO13-18
Bender Wirth: 452 Typ L1



LED COB S-Type (LES 7)
FWHM 32.0°
Efficiency 77 %
Peak intensity 1.600 cd/lm
LEDs/each optic 1
Light colour White
Required components:
C13709_PF-SOCKET-VERO13-18
C12479_MIRELLA-DL
Bender Wirth: 452 Typ L1



LED COB S-Type (LES 7)
FWHM 28.0°
Efficiency 81 %
Peak intensity 2.200 cd/lm
LEDs/each optic 1
Light colour White
Required components:
C13709_PF-SOCKET-VERO13-18
C13333_MIRELLA-CL
Bender Wirth: 452 Typ L1

PHOTOMETRIC DATA (SIMULATED):

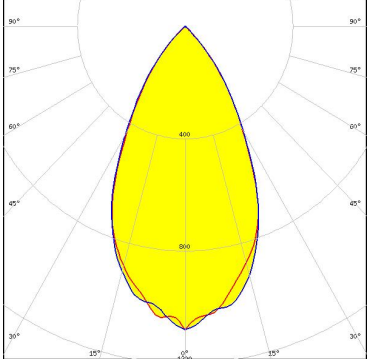
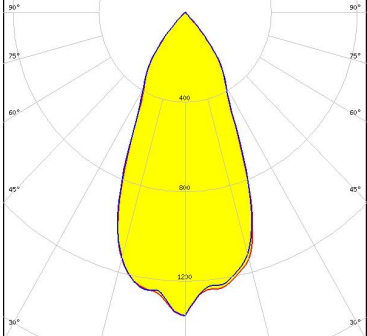
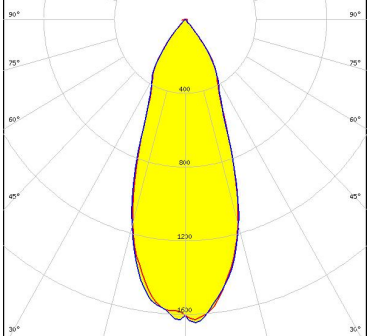
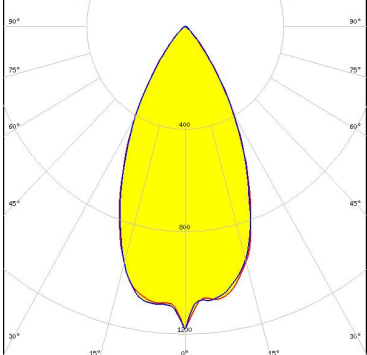
<p>OSRAM Opto Semiconductors</p> <p>LED Soleriq S15 FWHM 56.0° Efficiency 86 % Peak intensity 1.081 cd/lm LEDs/each optic 1 Light colour White Required components: C13709_PF-SOCKET-VERO13-18 Bender Wirth: 433 Typ L1</p>	
<p>OSRAM Opto Semiconductors</p> <p>LED Soleriq S9 FWHM 46.0° Efficiency 91 % Peak intensity 1.400 cd/lm LEDs/each optic 1 Light colour White Required components: C13083_PF-SOCKET</p>	
<p>OSRAM Opto Semiconductors</p> <p>LED Soleriq S9 FWHM 38.0° Efficiency 88 % Peak intensity 1.700 cd/lm LEDs/each optic 1 Light colour White Required components: C13709_PF-SOCKET-VERO13-18</p>	
<p>OSRAM Opto Semiconductors</p> <p>LED Soleriq S9 FWHM 50.0° Efficiency 85 % Peak intensity 1.200 cd/lm LEDs/each optic 1 Light colour White Required components: C13083_PF-SOCKET C13723_MIRELLA-RZL</p>	

PHOTOMETRIC DATA (SIMULATED):

OSRAM

Opto Semiconductors

LED Soleriq S9
 FWHM 52.0°
 Efficiency 85 %
 Peak intensity 1.100 cd/lm
 LEDs/each optic 1
 Light colour White
 Required components:
 C13083_PF-SOCKET
 C13333_MIRELLA-CL

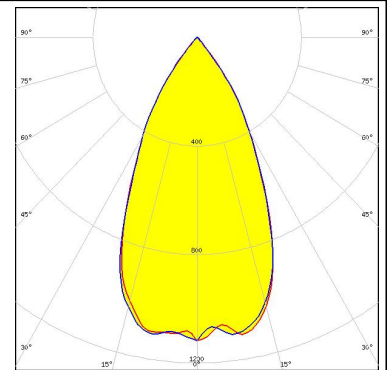

OSRAM

Opto Semiconductors

LED Soleriq S9
 FWHM 51.0°
 Efficiency 85 %
 Peak intensity 1.200 cd/lm
 LEDs/each optic 1
 Light colour White
 Required components:
 C13083_PF-SOCKET
 C12479_MIRELLA-DL

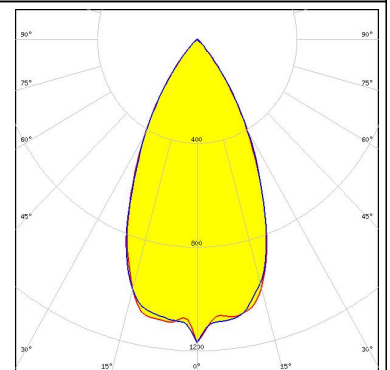

SAMSUNG

LED LC010C
 FWHM 32.0°
 Efficiency 87 %
 Peak intensity 2.200 cd/lm
 LEDs/each optic 1
 Light colour White
 Required components:
 C13709_PF-SOCKET-VERO13-18
 Bender Wirth: 479 Typ L1

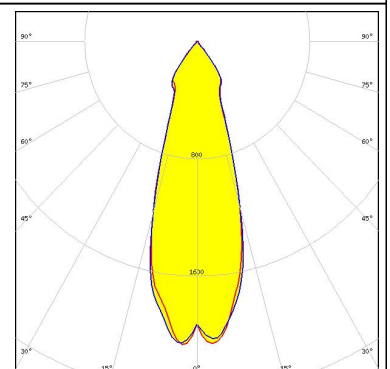

SAMSUNG

LED LC020C
 FWHM 35.0°
 Efficiency 86 %
 Peak intensity 1.900 cd/lm
 LEDs/each optic 1
 Light colour White
 Required components:
 C13709_PF-SOCKET-VERO13-18
 Bender Wirth: 479 Typ L1

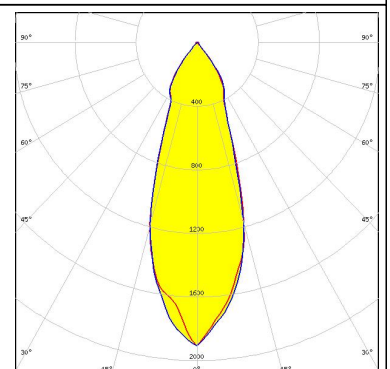

PHOTOMETRIC DATA (SIMULATED):

SAMSUNG

LED LC040C
 FWHM 42.0°
 Efficiency 84 %
 Peak intensity 1.400 cd/lm
 LEDs/each optic 1
 Light colour White
 Required components:
 C13709_PF-SOCKET-VERO13-18
 Bender Wirth: 480 Typ L1

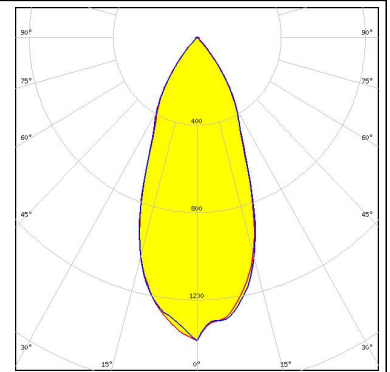

SEOUL SEMICONDUCTOR

LED ZC4/6
 FWHM 41.0°
 Efficiency 76 %
 Peak intensity 1.300 cd/lm
 LEDs/each optic 1
 Light colour White
 Required components:
 C13709_PF-SOCKET-VERO13-18
 C12479_MIRELLA-DL
 Bender Wirth: 434 Typ L1



SEOUL SEMICONDUCTOR

LED ZC4/6
 FWHM 36.0°
 Efficiency 84 %
 Peak intensity 1.700 cd/lm
 LEDs/each optic 1
 Light colour White
 Required components:
 C13709_PF-SOCKET-VERO13-18
 Bender Wirth: 434 Typ L1



SEOUL SEMICONDUCTOR

LED ZC4/6
 FWHM 39.0°
 Efficiency 78 %
 Peak intensity 1.500 cd/lm
 LEDs/each optic 1
 Light colour White
 Required components:
 C13709_PF-SOCKET-VERO13-18
 C13333_MIRELLA-CL
 Bender Wirth: 434 Typ L1

GENERAL INFORMATION:

NOTE: The typical beam angle will be changed by different color, chip size and chip position tolerance. The typical total beam angle is the full angle measured where the luminous intensity is half of the peak value.

Due to use of high power COB's with this product, special attention to proper thermal design is highly recommended. LEDiL has no liability for direct, indirect or consecutive damages arising from the LEDiL products being used outside of the recommended temperature range.

MATERIALS:

As part of our continuous research and improvement processes, and to ensure the best possible quality and availability of our products, LEDiL reserves the right to change material grades without notice.

PRODUCT DATA USER AGREEMENT AND DISCLAIMER:

The measured data in the provided downloadable LEDiL Product Datasheets and Mechanical 2D-Drawings is rounded and provided as reference for planning. LEDiL Oy's optical specifications have been verified by conducting performance testing of the products in accordance with the company's quality system. The reported data are averaged results of multiple measurements with typical variation. LEDiL Oy reserves the right to without prior notification make changes and improvements to its products.

LEDiL Oy assumes neither warranty, nor guarantee nor any other liability of any kind for the contents and correctness of the provided data. The provided data has been generated with highest diligence but the provided data may in reality not represent the complete possible variation range of all intrinsic parameters. Therefore, in certain cases a deviation from the provided data could occur.

LEDiL Oy reserves the right to undertake technical changes of its products without further notification which could lead to changes in the provided data. LEDiL Oy assumes no liability of any kind for the possible deviation from any provided data or any other damage resulting from the usage of the provided data.

The user agrees to this disclaimer and user agreement with the download or usage of the provided files.

LEDiL Oy

Joensuunkatu 13
FI-24240 SALO
Finland

LEDiL Inc.

228 West Page Street
Suite D
Sycamore IL 60178
USA

Local sales and technical support

[www.ledil.com/
where_to_buy](http://www.ledil.com/where_to_buy)

Shipping locations

Salo, Finland
Hong Kong, China

Distribution Partners

[www.ledil.com/
where_to_buy](http://www.ledil.com/where_to_buy)