

# Automotive Ferrite Chip Beads



AFBC-Q3211

Request Samples



Check Inventory



3.20 x 1.60 x 1.10 mm  
RoHS/RoHS II Compliant  
MSL Level = 1

## Features

- AEC-Q200 Qualified
- Operating Temperature: -55 ~ +150°C
- Wide range impedance
- Monolithic inorganic material construction
- Excellent heat resistance
- Current rating up to 3A

## Applications

- Electronic control Units (ECUs)
- Battery Management Systems (BMS)
- Powertrain system
- DC/AC Converters
- Industrial connectivity (IIoT)

## Electrical Specifications

Part Number	Impedance	DC Resistance	Rated Current
Units	$\Omega \pm 25\%$	$\Omega$ Max.	mA Max.
Symbol	Z	R <sub>DC</sub>	I <sub>R</sub>
AFBC-Q3211-300-T	30	0.04	3000
AFBC-Q3211-500-T	50	0.04	3000
AFBC-Q3211-800-T	80	0.04	3000
AFBC-Q3211-121-T	120	0.10	2000
AFBC-Q3211-151-T	150	0.10	2000
AFBC-Q3211-301-T	300	0.20	1000
AFBC-Q3211-471-T	470	0.20	1000
AFBC-Q3211-501-T	500	0.04	3000
AFBC-Q3211-601-T	600	0.10	2000

### Test Conditions and Equipment

Impedance Test Frequency: 100MHz

I<sub>R</sub>: Temperature Rise: 40°C Max. At Rated Current  $\geq 1A$ .

**Operating Temperature:** -55°C to +150°C (Including Self-Temperature rise)

**Storage Temperature:** <+40°C and RH 60% (Max).

**AFBC-Q3211 is RoHS Compliant and Pb free**

# Automotive Ferrite Chip Beads



**AFBC-Q3211**

Request Samples



Check Inventory



**3.20 x 1.60 x 1.10 mm**  
**RoHS/RoHS II Compliant**  
**MSL Level = 1**

## Electrical Specifications (Cont'd)

AFBC-Q3211-300

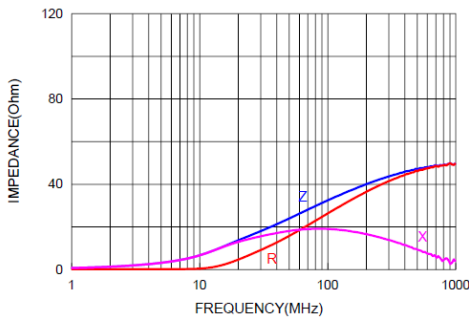

AFBC-Q3211-500

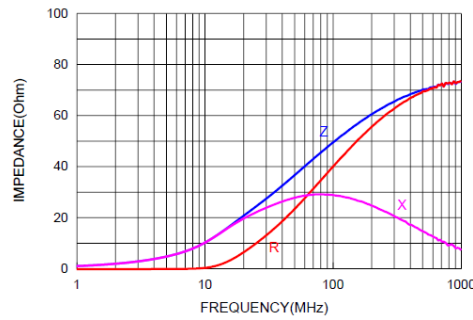

AFBC-Q3211-800

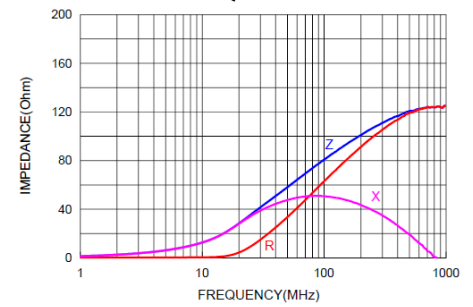

AFBC-Q3211-121

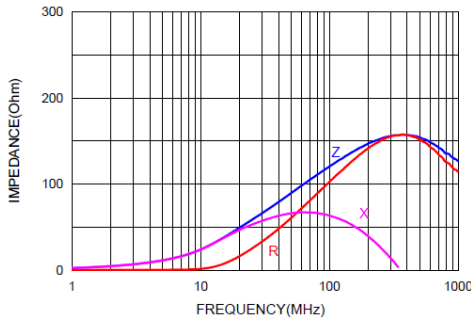

AFBC-Q3211-151

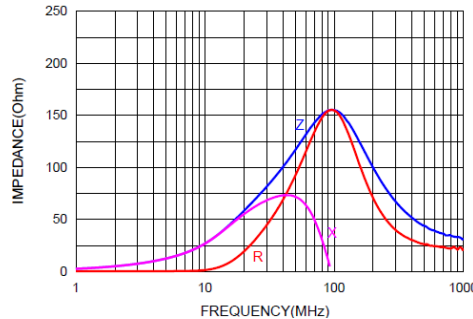

AFBC-Q3211-301

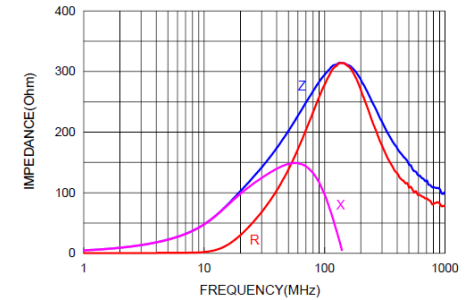

AFBC-Q3211-471

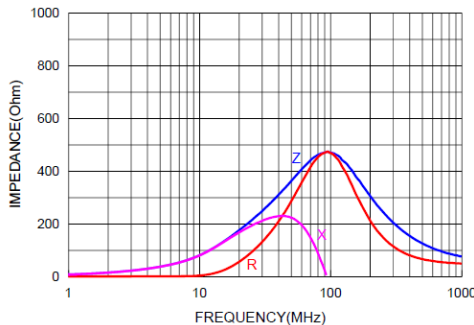

AFBC-Q3211-501

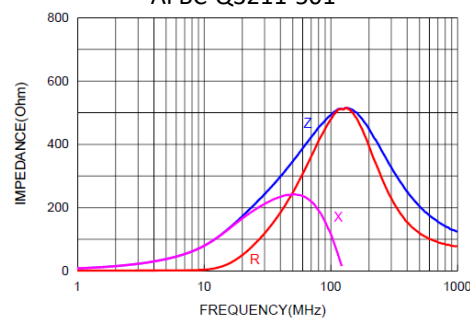

AFBC-Q3211-601

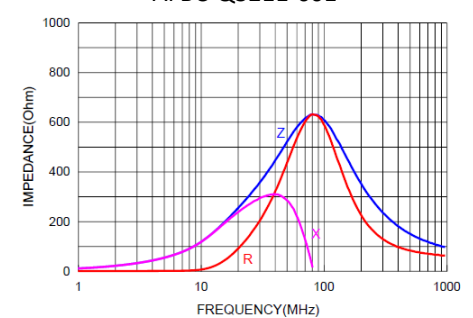

5101 Hidden Creek Ln Spicewood TX 78669  
 Phone: 512-371-6159 | Fax: 512-351-8858  
 For terms and conditions of sales, please visit:  
[www.abracon.com](http://www.abracon.com)

REVISION: IR 08-10-22

ABRACON IS  
 ISO9001-2015  
 CERTIFIED

# Automotive Ferrite Chip Beads



**AFBC-Q3211**

Request Samples



Check Inventory



**3.20 x 1.60 x 1.10 mm**  
**RoHS/RoHS II Compliant**  
**MSL Level = 1**

## Part Number Identification

AFBC - Q3211 -  -

**Impedance Code**  
 Please refer to the  
 Electrical Specification  
 table

**Packaging**  
 T: Tape and Reel  
 (3kpcs / reel)

## Mechanical Specifications

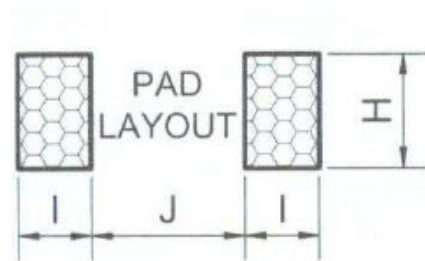
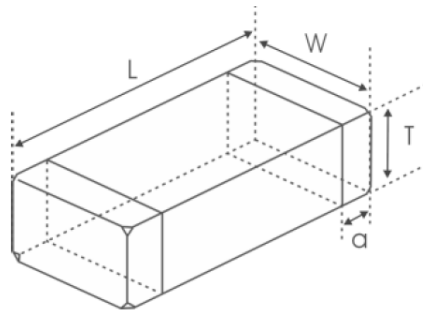

L	W	T	a	H	I	J
3.20±0.20	1.60±0.20	1.10±0.20	0.50±0.30	1.80 Ref.	1.05 Ref.	2.20 Ref.

**Dimension: mm**

# Automotive Ferrite Chip Beads



AFBC-Q3211

Request Samples



Check Inventory



3.20 x 1.60 x 1.10 mm  
RoHS/RoHS II Compliant  
MSL Level = 1

## Materials

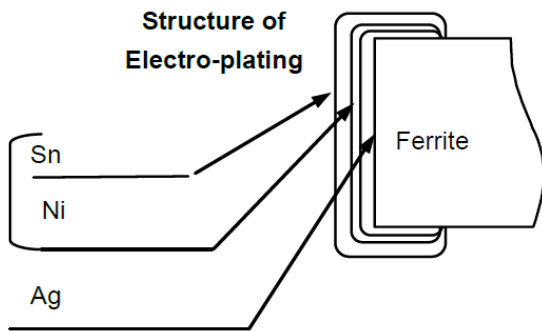

	Structure Description
1	Ferrite for Beads
2	Internal Terminal Electrode: Ag (100%)
3	Electro-plating: Ni (100%)
4	External Electro-plating: Sn (100%)

## Reflow Profile

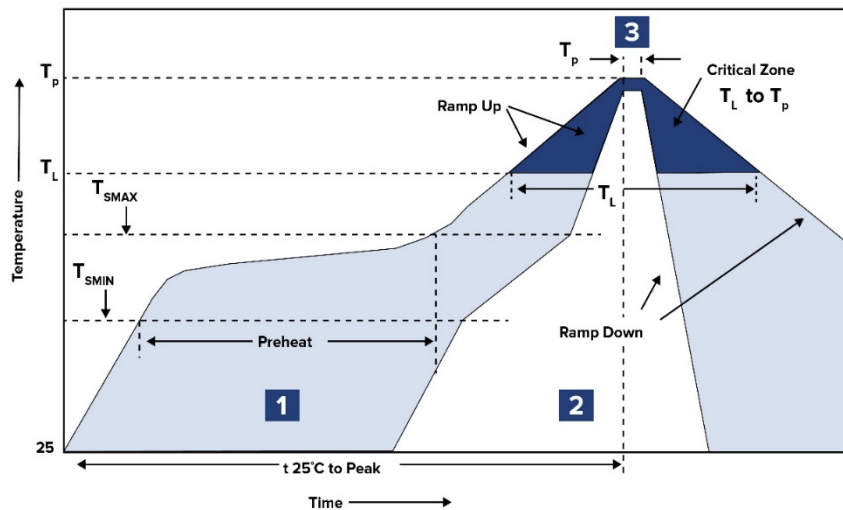

Zone	Description	Temperature	Times
1	Preheat	$T_{SMIN} \sim T_{SMAX}$ 150°C ~ 200°C	60 ~ 180 sec.
2	Reflow	$T_L$ 245°C	20 ~ 40 sec.
3	Peak heat	$T_P$ 260°C	10 sec. MAX

# Automotive Ferrite Chip Beads

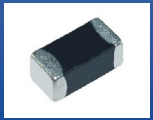

**AFBC-Q3211**

Request Samples



Check Inventory



**3.20 x 1.60 x 1.10 mm**  
**RoHS/RoHS II Compliant**  
**MSL Level = 1**

## Packaging

**T= Tape and reel (3,000 pcs/reel)**

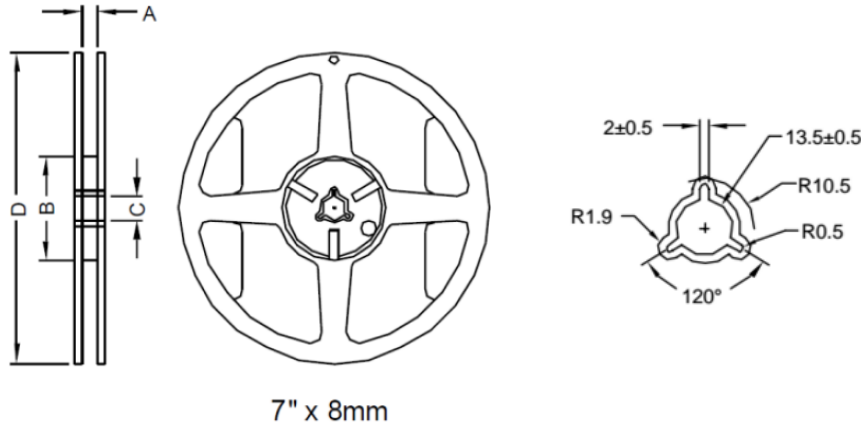

Type	A	B	C	D
7"x8mm	9.0 ± 0.5	60.0 ± 2.0	13.5 ± 0.5	178.0 ± 2.0

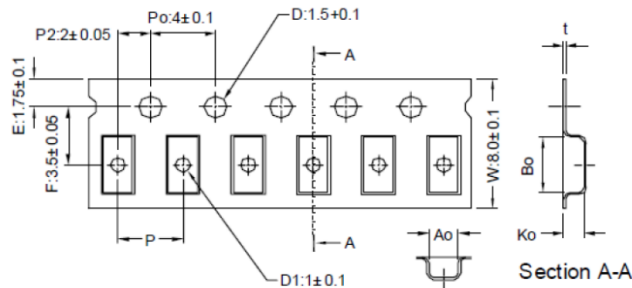

Series	Bo	Ao	Ko	P
AFBC-Q3211	3.35 ± 0.1	1.75 ± 0.1	1.25 ± 0.1	4.00 ± 0.10

**Dimension: mm**

**ATTENTION:** Abracon LLC's products are COTS – Commercial-Off-The-Shelf products; suitable for Commercial, Industrial and, where designated, Automotive Applications. Abracon's products are not specifically designed for Military, Aviation, Aerospace, Life-dependent Medical applications or any application requiring high reliability where component failure could result in loss of life and/or property. For applications requiring high reliability and/or presenting an extreme operating environment, written consent and authorization from Abracon LLC is required. Please contact Abracon LLC for more information.



5101 Hidden Creek Ln Spicewood TX 78669  
 Phone: 512-371-6159 | Fax: 512-351-8858  
 For terms and conditions of sales, please visit:  
[www.abracon.com](http://www.abracon.com)

**REVISION: IR 08-10-22**

ABRACON IS  
 ISO9001-2015  
 CERTIFIED