



NPN SILICON GERMANIUM RF TRANSISTOR

NESG250134

NPN SiGe RF TRANSISTOR FOR MEDIUM OUTPUT POWER AMPLIFICATION (800 mW) 3-PIN POWER MINIMOLD (34 PACKAGE)

FEATURES

- This product is suitable for medium output power (800 mW) amplification
 $P_o = 29$ dBm TYP. @ $V_{CE} = 3.6$ V, $P_{in} = 15$ dBm, $f = 460$ MHz
 $P_o = 29$ dBm TYP. @ $V_{CE} = 3.6$ V, $P_{in} = 20$ dBm, $f = 900$ MHz
- MSG (Maximum Stable Gain) = 23 dB TYP., @ $V_{CE} = 3.6$ V, $I_c = 100$ mA, $f = 460$ MHz
- Using UHS2-HV process (SiGe technology), V_{CBO} (ABSOLUTE MAXIMUM RATINGS) = 20 V
- 3-pin power minimold (34 package)

ORDERING INFORMATION

Part Number	Quantity	Supplying Form
NESG250134-A	25 pcs (Non reel)	• 12 mm wide embossed taping • Pin 2 (Emitter) face the perforation side of the tape
NESG250134-T1-A	1 kpcs/reel	

Remark To order evaluation samples, contact your nearby sales office.
Unit sample quantity is 25 pcs.

ABSOLUTE MAXIMUM RATINGS ($T_A = +25^\circ\text{C}$)

Parameter	Symbol	Ratings	Unit
Collector to Base Voltage	V_{CBO}	20	V
Collector to Emitter Voltage	V_{CEO}	9.2	V
Emitter to Base Voltage	V_{EBO}	2.8	V
Collector Current	I_c	500	mA
Total Power Dissipation	P_{tot} ^{Note}	1.5	W
Junction Temperature	T_j	150	$^\circ\text{C}$
Storage Temperature	T_{stg}	-65 to +150	$^\circ\text{C}$

Note Mounted on $34.2 \text{ cm}^2 \times 0.8 \text{ mm}$ (t) glass epoxy PWB

Caution: Observe precautions when handling because these devices are sensitive to electrostatic discharge

The information in this document is subject to change without notice. Before using this document, please confirm that this is the latest version.

THERMAL RESISTANCE (T_A = +25°C)

Parameter	Symbol	Ratings	Unit
Thermal Resistance from Junction to Ambient ^{Note}	R _{thj-a}	80	°C/W

Note Mounted on 34.2 cm² × 0.8 mm (t) glass epoxy PWB

RECOMMENDED OPERATING RANGE (T_A = +25°C)

Parameter	Symbol	MIN.	TYP.	MAX.	Unit
Collector to Emitter Voltage	V _{CE}	–	3.6	4.5	V
Collector Current	I _c	–	400	500	mA
Input Power ^{Note}	P _{in}	–	12	17	dBm

Note Input power under conditions of V_{CE} ≤ 4.5 V, f = 460 MHz

ELECTRICAL CHARACTERISTICS (T_A = +25°C)

Parameter	Symbol	Test Conditions	MIN.	TYP.	MAX.	Unit
DC Characteristics						
Collector Cut-off Current	I _{CBO}	V _{CB} = 5 V, I _E = 0 mA	–	–	1	μA
Emitter Cut-off Current	I _{EBO}	V _{EB} = 0.5 V, I _C = 0 mA	–	–	1	μA
DC Current Gain	h _{FE} ^{Note 1}	V _{CE} = 3 V, I _C = 100 mA	80	120	180	–
RF Characteristics						
Gain Bandwidth Product	f _T	V _{CE} = 3.6 V, I _C = 100 mA, f = 460 MHz	–	10	–	GHz
Insertion Power Gain	S _{21e} ²	V _{CE} = 3.6 V, I _C = 100 mA, f = 460 MHz	–	19	–	dB
Maximum Satble Gain	MSG ^{Note 2}	V _{CE} = 3.6 V, I _C = 100 mA, f = 460 MHz	–	23	–	dB
Linner gain (1)	G _L	V _{CE} = 3.6 V, I _{C (set)} = 30 mA (RF OFF), f = 460 MHz, P _{in} = 0 dBm	16	19	–	dB
Linner gain (2)	G _L	V _{CE} = 3.6 V, I _{C (set)} = 30 mA (RF OFF), f = 900 MHz, P _{in} = 0 dBm	–	16	–	dB
Output Power (1)	P _O	V _{CE} = 3.6 V, I _{C (set)} = 30 mA (RF OFF), f = 460 MHz, P _{in} = 15 dBm	27	29	–	dBm
Output Power (2)	P _O	V _{CE} = 3.6 V, I _{C (set)} = 30 mA (RF OFF), f = 900 MHz, P _{in} = 20 dBm	–	29	–	dBm
Collector Efficiency (1)	η _c	V _{CE} = 3.6 V, I _{C (set)} = 30 mA (RF OFF), f = 460 MHz, P _{in} = 15 dBm	–	60	–	%
Collector Efficiency (2)	η _c	V _{CE} = 3.6 V, I _{C (set)} = 30 mA (RF OFF), f = 900 MHz, P _{in} = 20 dBm	–	60	–	%

Notes 1. Pulse measurement: PW ≤ 350 μs, Duty Cycle ≤ 2%

2. $MSG = \left| \frac{S_{21}}{S_{12}} \right|$

h_{FE} CLASSIFICATION

Rank	FB
Marking	SN
h _{FE} Value	80 to 180

■ TYPICAL CHARACTERISTICS ($T_A = +25^\circ\text{C}$, unless otherwise specified)

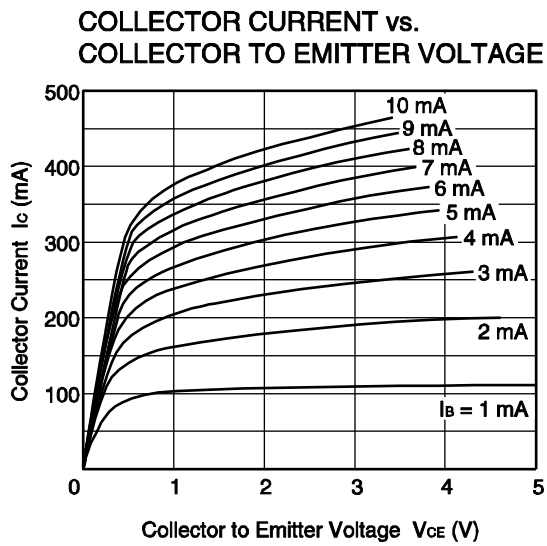
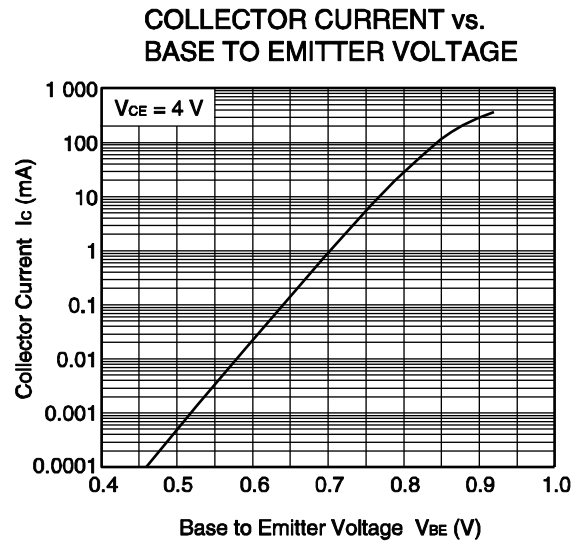
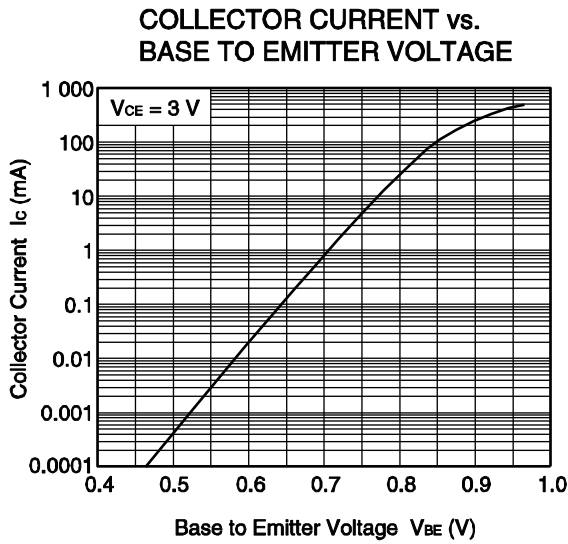
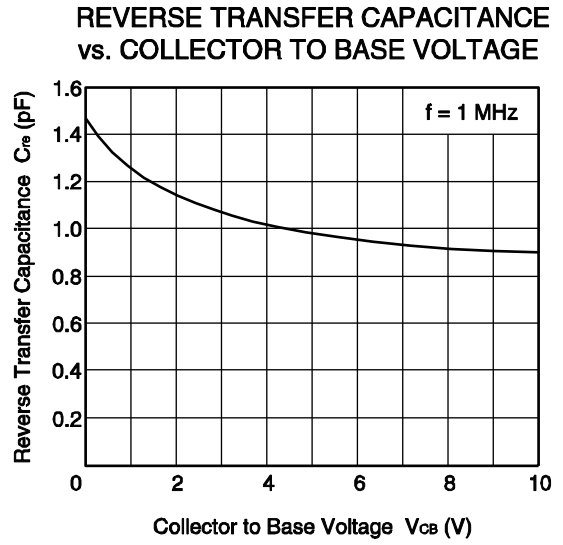
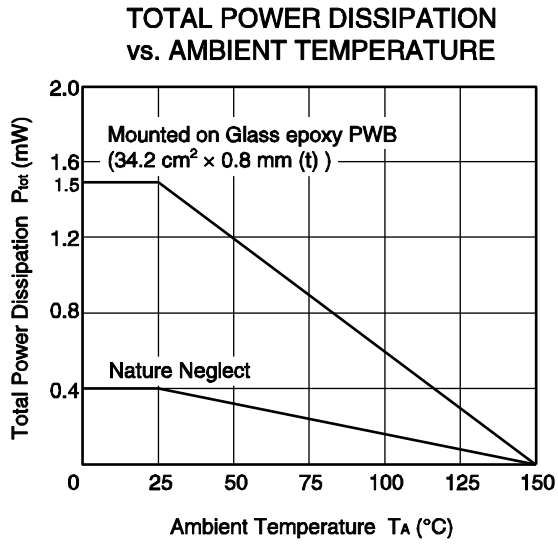

Remark The graphs indicate nominal characteristics.

DC CURRENT GAIN vs. COLLECTOR CURRENT

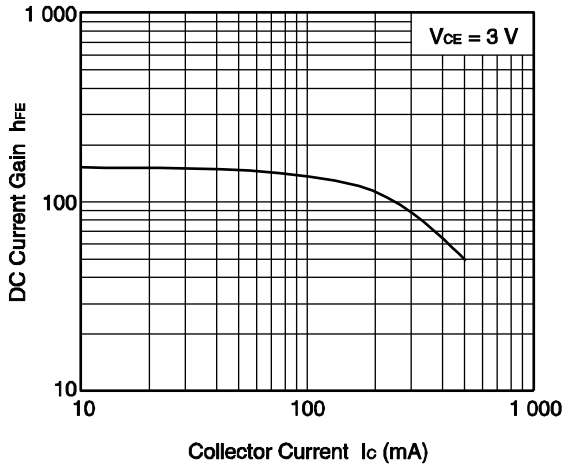

DC CURRENT GAIN vs. COLLECTOR CURRENT

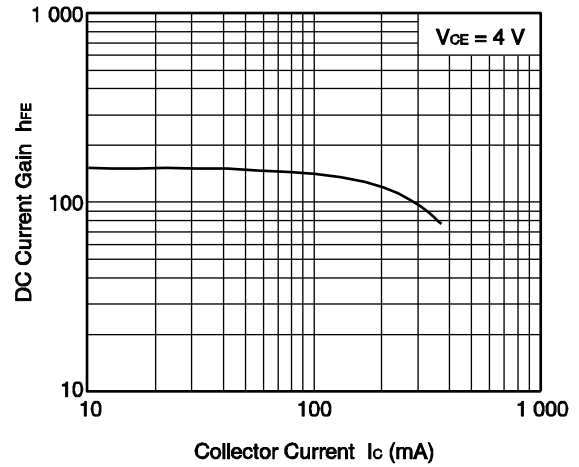

GAIN BANDWIDTH PRODUCT vs. COLLECTOR CURRENT

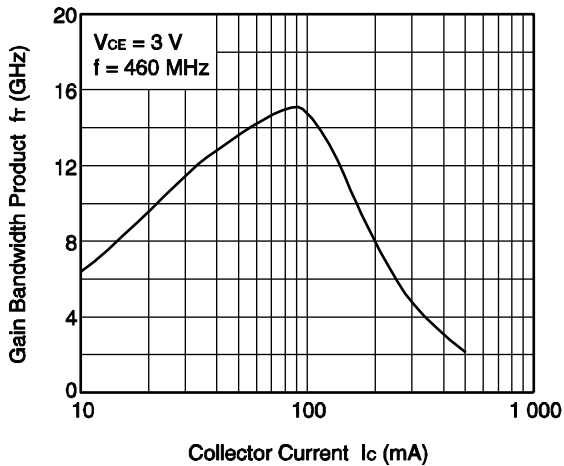

GAIN BANDWIDTH PRODUCT vs. COLLECTOR CURRENT

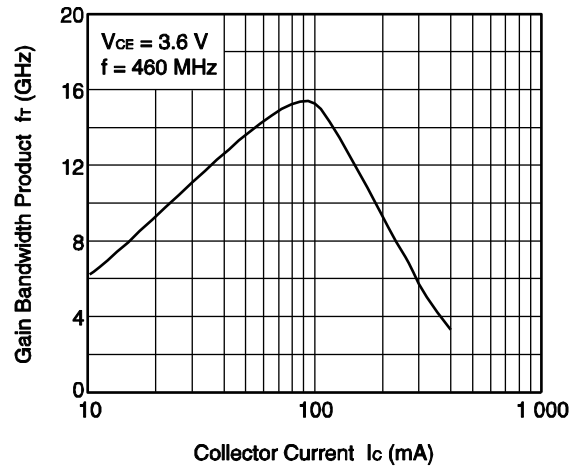

GAIN BANDWIDTH PRODUCT vs. COLLECTOR CURRENT

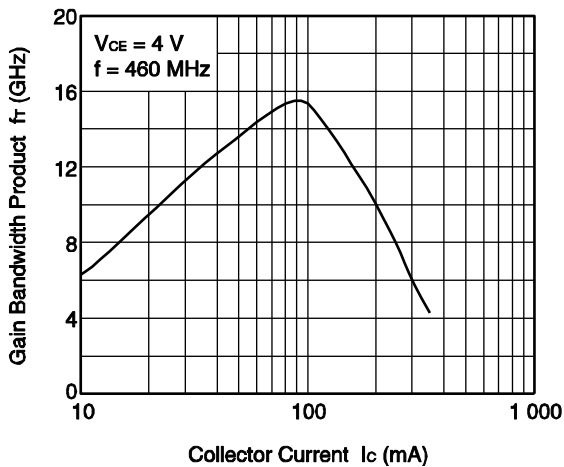

INSERTION POWER GAIN, MAG, MSG vs. FREQUENCY

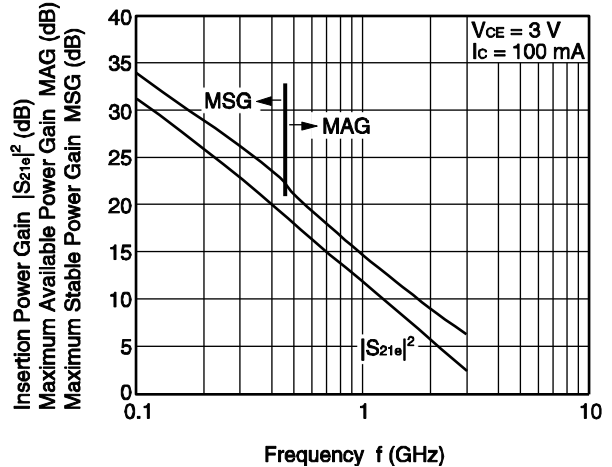

Remark The graphs indicate nominal characteristics.

INSERTION POWER GAIN, MAG, MSG vs. FREQUENCY

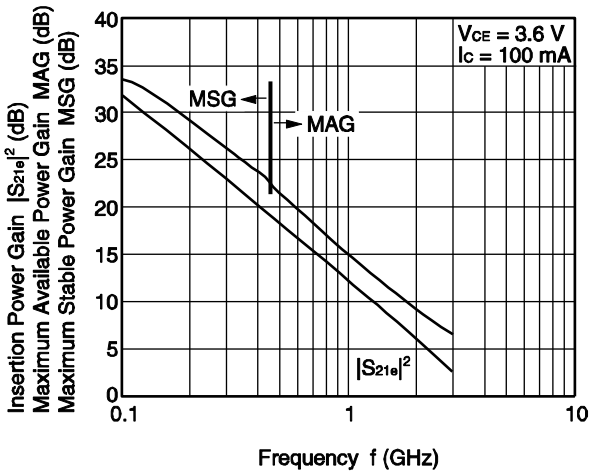

INSERTION POWER GAIN, MAG, MSG vs. FREQUENCY

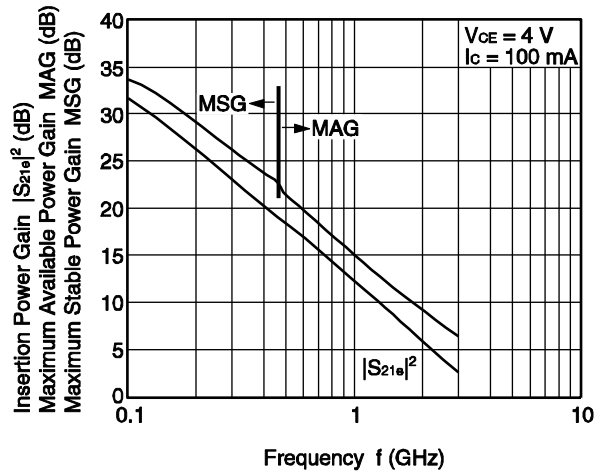

INSERTION POWER GAIN, MAG, MSG vs. COLLECTOR CURRENT

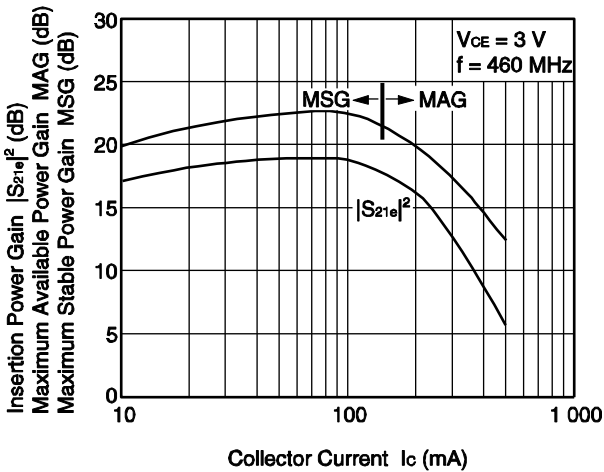

INSERTION POWER GAIN, MAG, MSG vs. COLLECTOR CURRENT

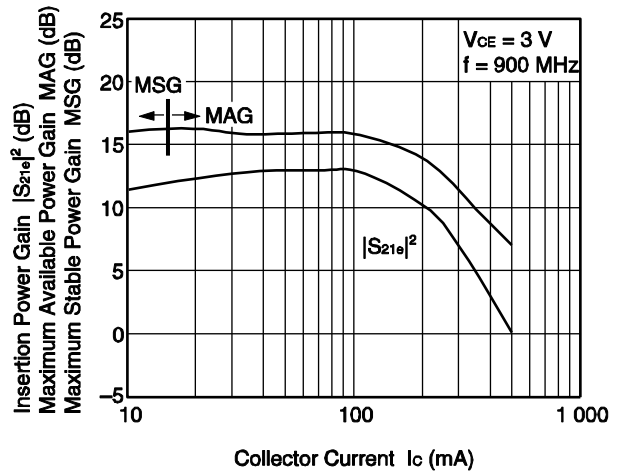

INSERTION POWER GAIN, MAG, MSG vs. COLLECTOR CURRENT

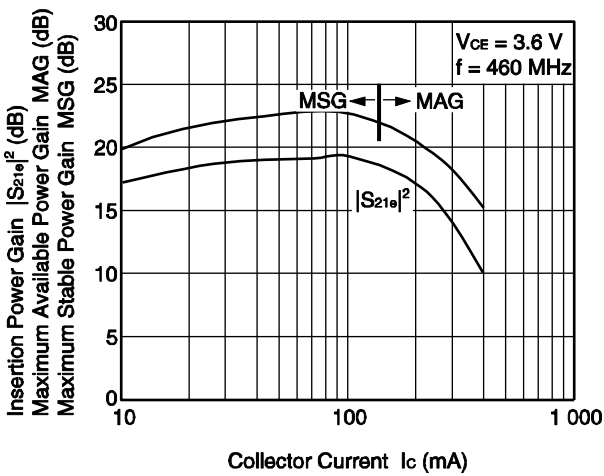

INSERTION POWER GAIN, MAG, MSG vs. COLLECTOR CURRENT

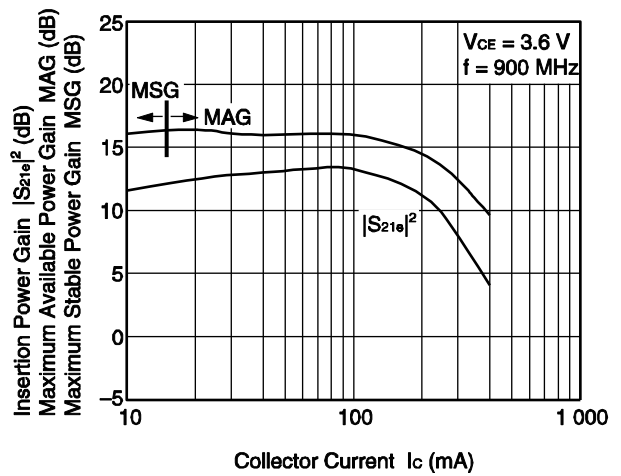

Remark The graphs indicate nominal characteristics.

INSERTION POWER GAIN, MAG, MSG vs. COLLECTOR CURRENT

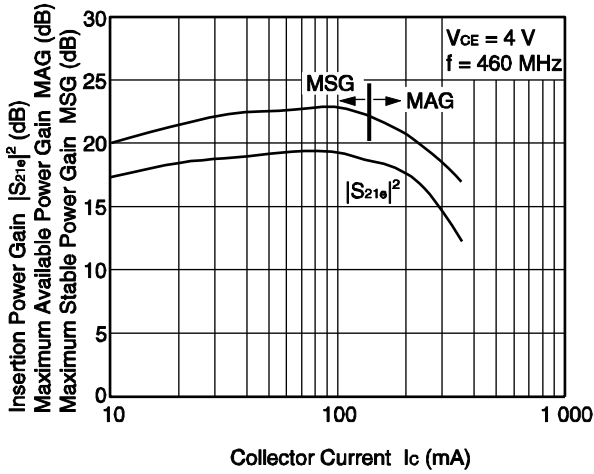

INSERTION POWER GAIN, MAG, MSG vs. COLLECTOR CURRENT

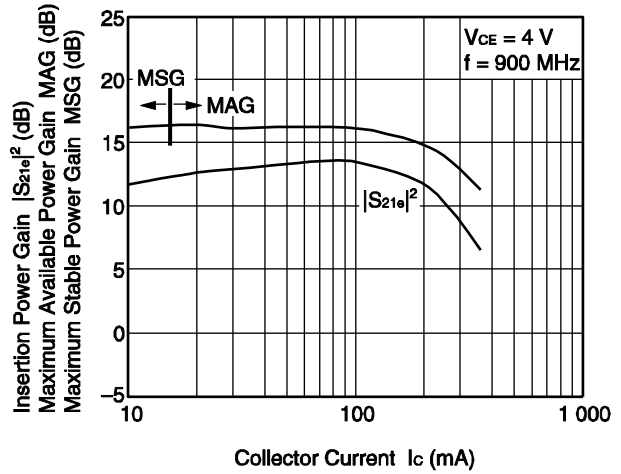

OUTPUT POWER, POWER GAIN, COLLECTOR CURRENT, COLLECTOR EFFICIENCY vs. INPUT POWER

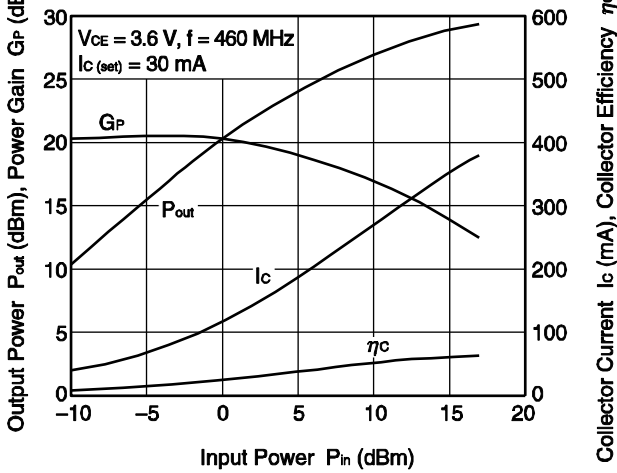

OUTPUT POWER, POWER GAIN, COLLECTOR CURRENT, COLLECTOR EFFICIENCY vs. INPUT POWER

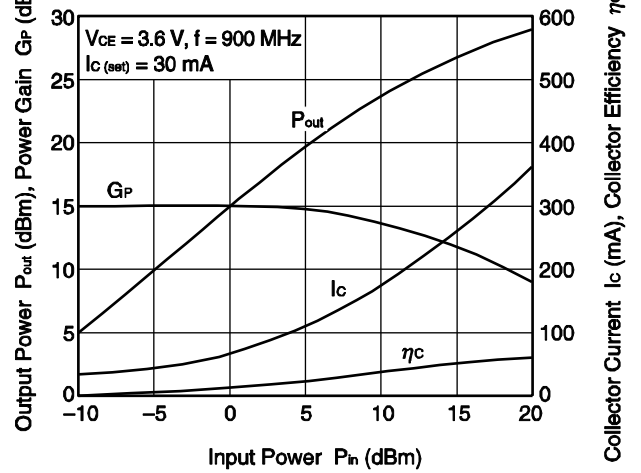

NOISE FIGURE, ASSOCIATED GAIN vs. COLLECTOR CURRENT

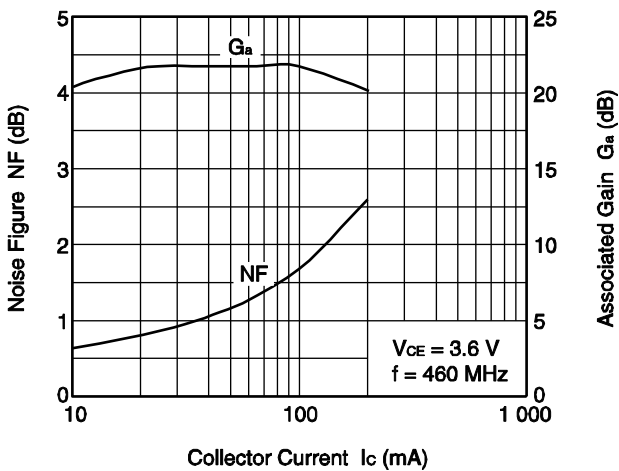

Remark The graphs indicate nominal characteristics.

PA EVALUATION BOARD (f = 460 MHz)

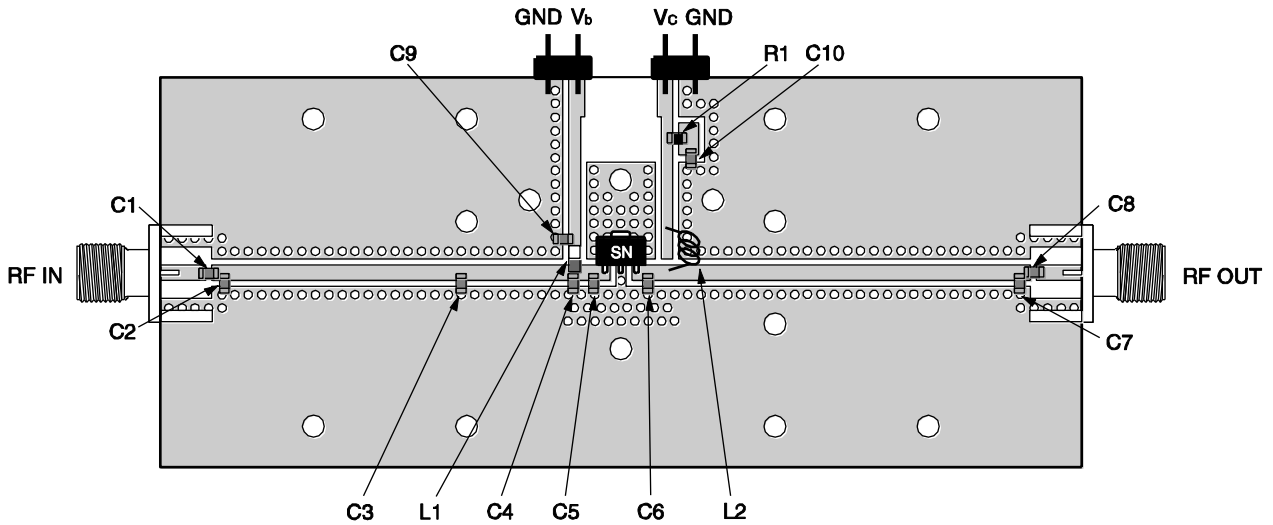

Notes

1. 38 × 90 mm, t = 0.8 mm double sided copper clad glass epoxy PWB.
2. Back side: GND pattern
3. Solder gold plated on pattern
4. ○: Through holes

PA EVALUATION CIRCUIT (f = 460 MHz)

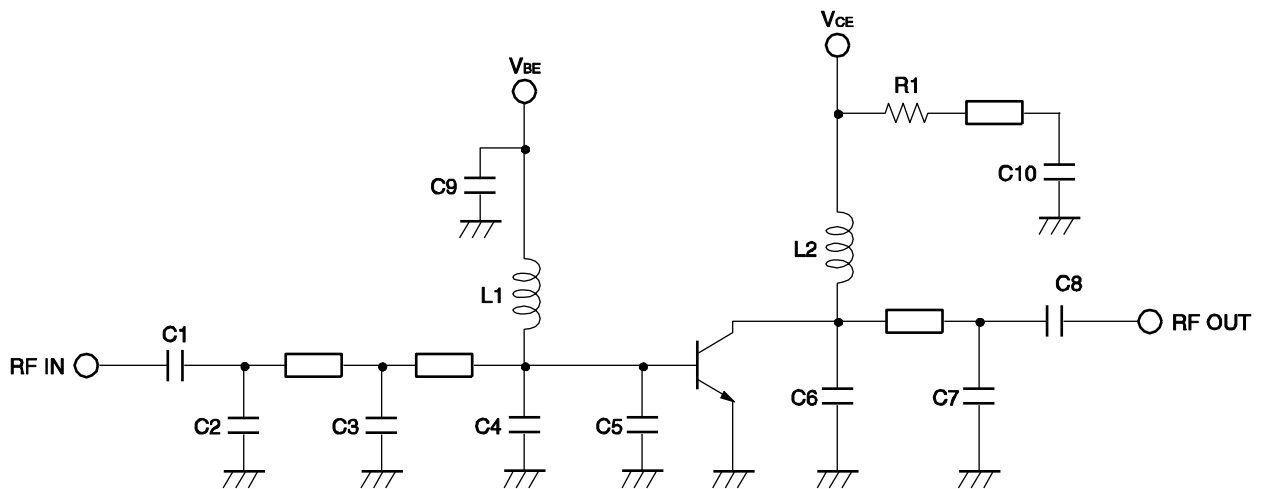

The application circuits and their parameters are for reference only and are not intended for use in actual design-ins.

COMPONENT LIST

	Value	Maker
C1	30 pF	Murata
C2	6 pF	Murata
C3, C4	7 pF	Murata
C5	3 pF	Murata
C6	0.5 pF	Murata
C7	5 pF	Murata
C8	10 pF	Murata
C9, C10	100 nF	Murata
L1	100 nH	Toko
L2	3 nH	Toko
R1	30 Ω	SSM

PA EVALUATION CIRCUIT TYPICAL CHARACTERISTICS

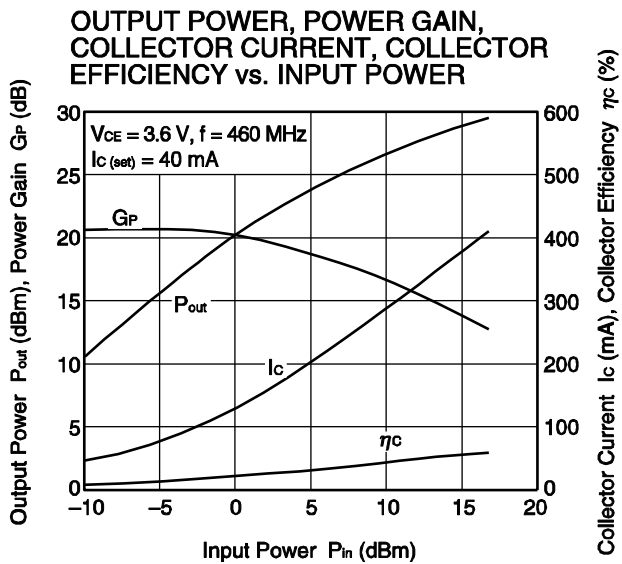

Remark The graph indicates nominal characteristics.

DISTORTION EVALUATION BOARD (f = 460 MHz)

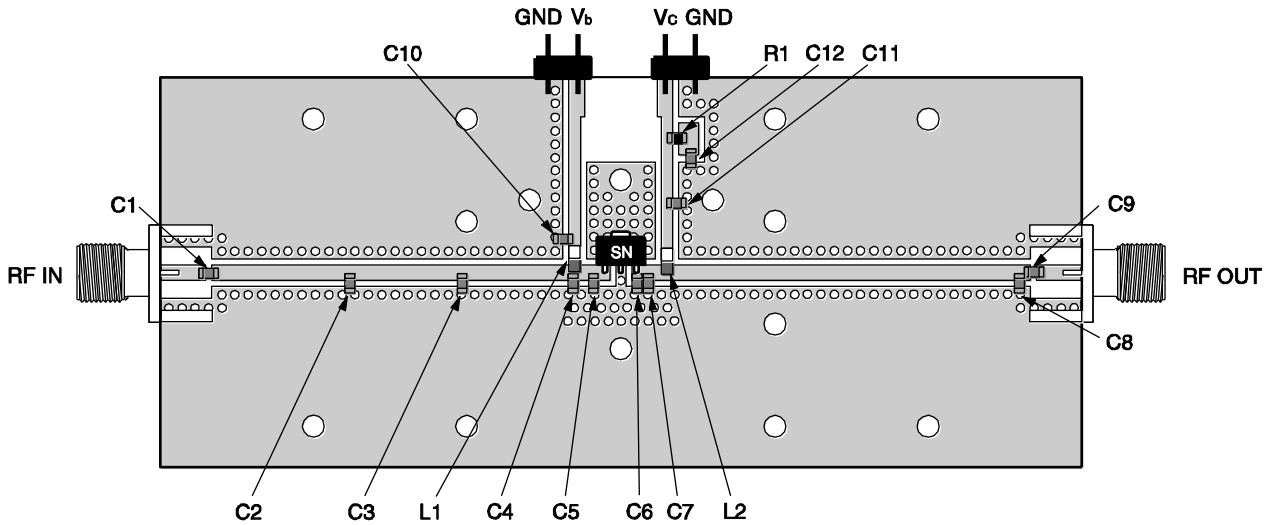

Notes

1. 38 × 90 mm, t = 0.8 mm, double sided copper clad glass epoxy PWB.
2. Back side: GND pattern
3. Solder gold plated on pattern
4. ◦○: Through holes

DISTORTION EVALUATION CIRCUIT (f = 460 MHz)

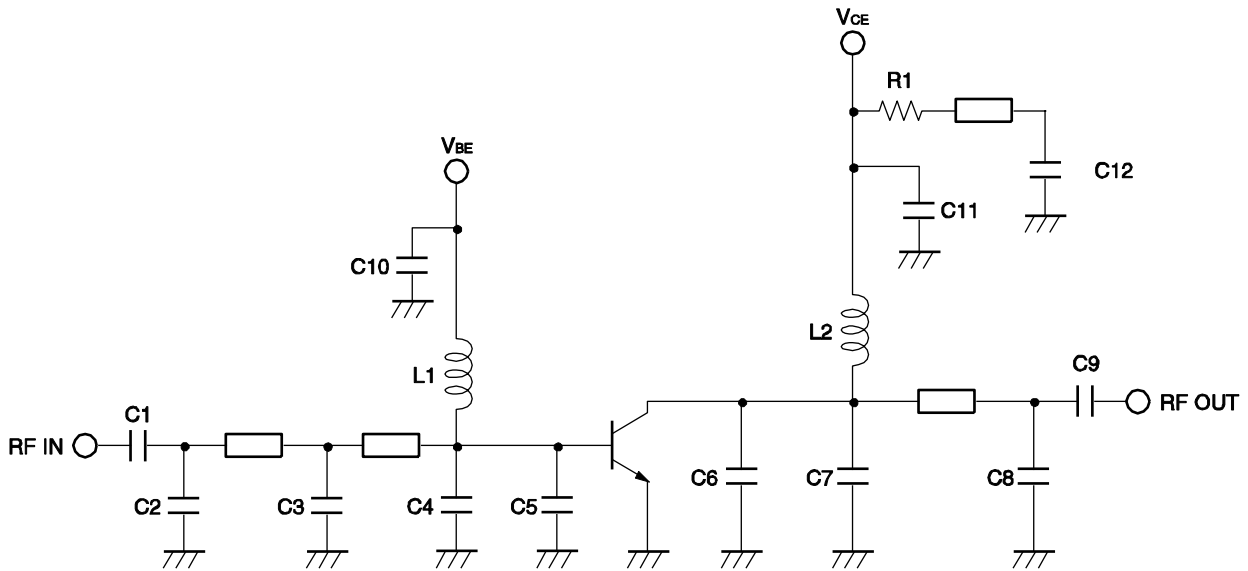

The application circuits and their parameters are for reference only and are not intended for use in actual design-ins.

COMPONENT LIST

	Value	Maker
C1	47 pF	Murata
C2	12 pF	Murata
C3, C4	7 pF	Murata
C5	3 pF	Murata
C6	6 pF	Murata
C7	0.5 pF	Murata
C8	5 pF	Murata
C9	51 pF	Murata
C10, C12	100 nF	Murata
C11	1 μ F	Murata
L1	100 nH	Toko
L2	15 nH	Toko
R1	30 Ω	SSM

DISTORTION EVALUATION CIRCUIT TYPICAL CHARACTERISTICS

**3RD ORDER
INTERMODULATION DISTORTION
vs. 1 TONE OUTPUT POWER**

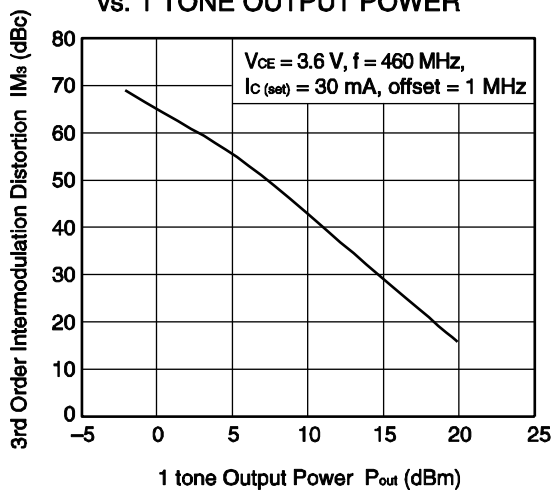

Remark The graph indicates nominal characteristics.

PACKAGE DIMENSIONS

3-PIN POWER MINIMOLD (34 PACKAGE) (UNIT: mm)

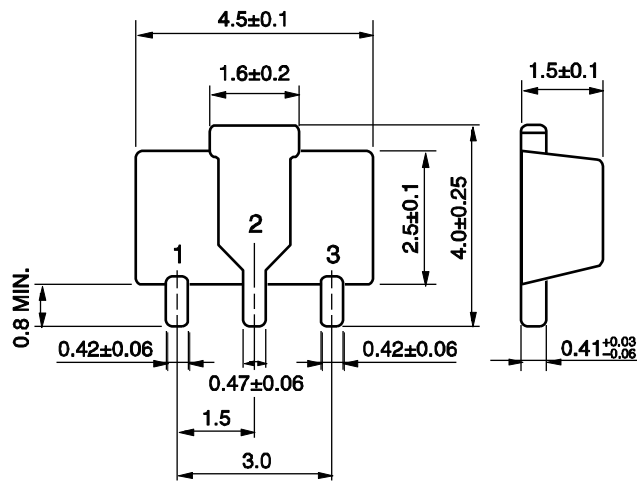

PIN CONNECTIONS

- 1. Collector
- 2. Emitter
- 3. Base

- **The information in this document is current as of July, 2004. The information is subject to change without notice. For actual design-in, refer to the latest publications of NEC's data sheets or data books, etc., for the most up-to-date specifications of NEC semiconductor products. Not all products and/or types are available in every country. Please check with an NEC sales representative for availability and additional information.**
- No part of this document may be copied or reproduced in any form or by any means without prior written consent of NEC. NEC assumes no responsibility for any errors that may appear in this document.
- NEC does not assume any liability for infringement of patents, copyrights or other intellectual property rights of third parties by or arising from the use of NEC semiconductor products listed in this document or any other liability arising from the use of such products. No license, express, implied or otherwise, is granted under any patents, copyrights or other intellectual property rights of NEC or others.
- Descriptions of circuits, software and other related information in this document are provided for illustrative purposes in semiconductor product operation and application examples. The incorporation of these circuits, software and information in the design of customer's equipment shall be done under the full responsibility of customer. NEC assumes no responsibility for any losses incurred by customers or third parties arising from the use of these circuits, software and information.
- While NEC endeavours to enhance the quality, reliability and safety of NEC semiconductor products, customers agree and acknowledge that the possibility of defects thereof cannot be eliminated entirely. To minimize risks of damage to property or injury (including death) to persons arising from defects in NEC semiconductor products, customers must incorporate sufficient safety measures in their design, such as redundancy, fire-containment, and anti-failure features.
- NEC semiconductor products are classified into the following three quality grades:
 "Standard", "Special" and "Specific". The "Specific" quality grade applies only to semiconductor products developed based on a customer-designated "quality assurance program" for a specific application. The recommended applications of a semiconductor product depend on its quality grade, as indicated below. Customers must check the quality grade of each semiconductor product before using it in a particular application.
 - "Standard": • Computers, office equipment, communications equipment, test and measurement equipment, audio and visual equipment, home electronic appliances, machine tools, personal electronic equipment and industrial robots
 - "Special": • Transportation equipment (automobiles, trains, ships, etc.), traffic control systems, anti-disaster systems, anti-crime systems, safety equipment and medical equipment (not specifically designed for life support)
 - "Specific": • Aircraft, aerospace equipment, submersible repeaters, nuclear reactor control systems, life support systems and medical equipment for life support, etc.
 The quality grade of NEC semiconductor products is "Standard" unless otherwise expressly specified in NEC's data sheets or data books, etc. If customers wish to use NEC semiconductor products in applications not intended by NEC, they must contact an NEC sales representative in advance to determine NEC's willingness to support a given application.

(Note)

 - (1) "NEC" as used in this statement means NEC Corporation, NEC Compound Semiconductor Devices, Ltd.
 - and also includes its majority-owned subsidiaries.
 - (2) "NEC semiconductor products" means any semiconductor product developed or manufactured by or for
 - NEC (as defined above).

M8E 00.4-0110

► **For further information, please contact**

NEC Compound Semiconductor Devices, Ltd. <http://www.ncsd.necel.com/>

E-mail: salesinfo@ml.ncsd.necel.com (sales and general)

techinfo@ml.ncsd.necel.com (technical)

Sales Division TEL: +81-44-435-1588 FAX: +81-44-435-1579

NEC Compound Semiconductor Devices Hong Kong Limited

E-mail: ncsd-hk@elhk.nec.com.hk (sales, technical and general)

Hong Kong Head Office TEL: +852-3107-7303 FAX: +852-3107-7309

Taipei Branch Office TEL: +886-2-8712-0478 FAX: +886-2-2545-3859

Korea Branch Office TEL: +82-2-558-2120 FAX: +82-2-558-5209

NEC Electronics (Europe) GmbH <http://www.ee.nec.de/>

TEL: +49-211-6503-0 FAX: +49-211-6503-1327

California Eastern Laboratories, Inc. <http://www.cel.com/>

TEL: +1-408-988-3500 FAX: +1-408-988-0279