

# 1570-1615 MHz GNSS ANTENNA, CHIP TYPE

## Standard Antenna Solutions

Part Number: 2195764-1

### PRODUCT FACTS:

- Embedded ceramic chip antenna
- SMT assembly
- Available in tap & reel
- RoHS compliant

### RECOMMENDATIONS:

- Minimum or no matching circuits required
- Bandwidth and performance is dependent on ground plane size. Evaluation board size is 80mm x 40mm
- PCB ground is to be on top layer

### SPECIFICATIONS:

- Frequency Range: 1570-1615 MHz
- Peak Gain:  $\leq 3.2$  dBi (Max)
- VSWR:  $< 2.0:1$
- Polarization: Linear
- Power Handling: 10 Watt cw
- Feed Point Impedance: 50 ohms
- Size: 5.2mm x 3.7mm x 0.7mm
- Mounting: Surface-mount technology
- Mounting Guide: See diagram on page 2
- Weight: 0.2 g
- Operating Temperature:  $-40^{\circ}$  to  $105^{\circ}\text{C}$

### TEST ORIENTATION IN FREE SPACE:

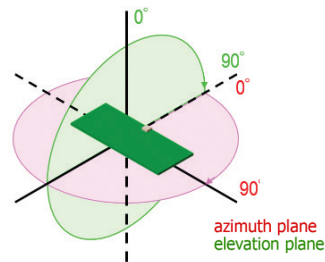

### VSWR:

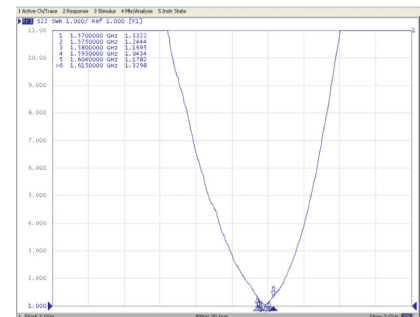

### AZIMUTH:

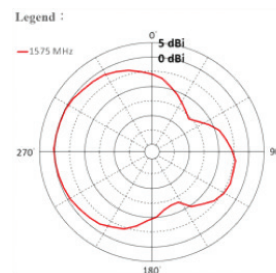

### ELEVATION:

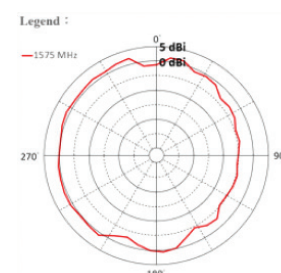

### EFFICIENCY:

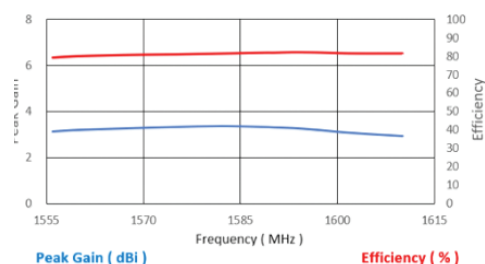

# 1570-1615 MHz GNSS Antenna, Chip Type

Standard Antenna Solutions

## MOUNTING GUIDE:

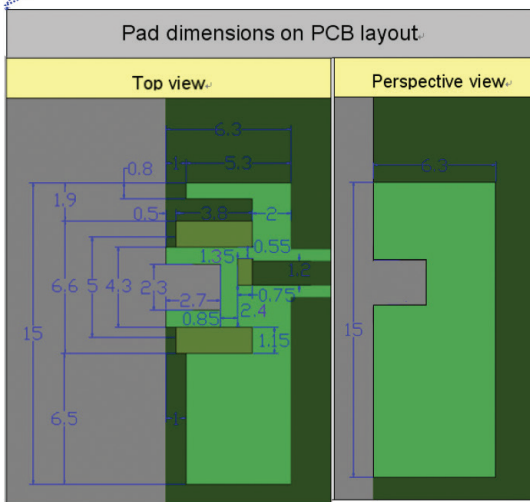
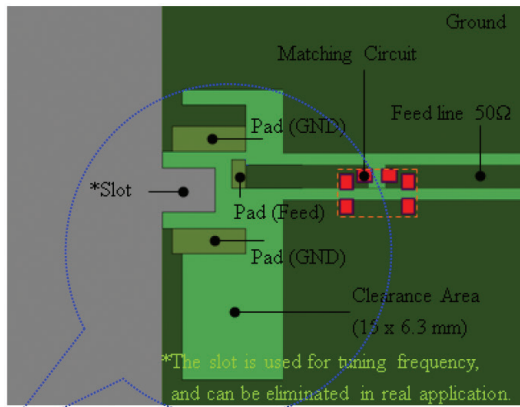

(Unit: mm)

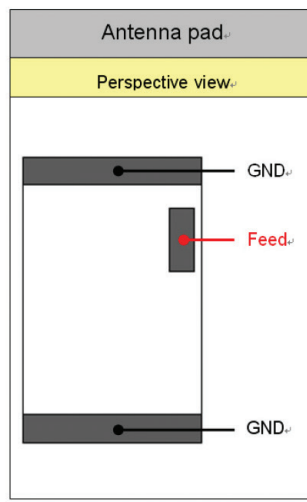

## KEEP OUT AREA:

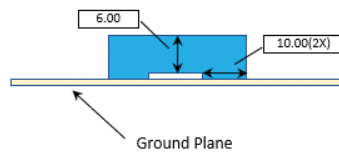
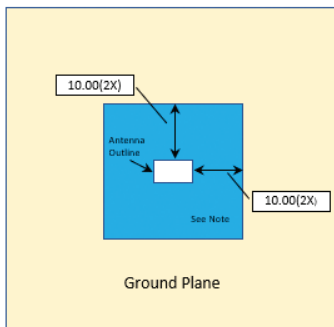

- NOTES :
1. Antenna designed to be mounted on ground plane.
  2. Area in blue above indicates Keep Out Area.
  3. For more information please call TE.

Dimensions : mm  
Diagram is not to scale

# 1570-1615 MHz GNSS Antenna, Chip Type

Standard Antenna Solutions

## APPROXIMATE DIMENSIONS:

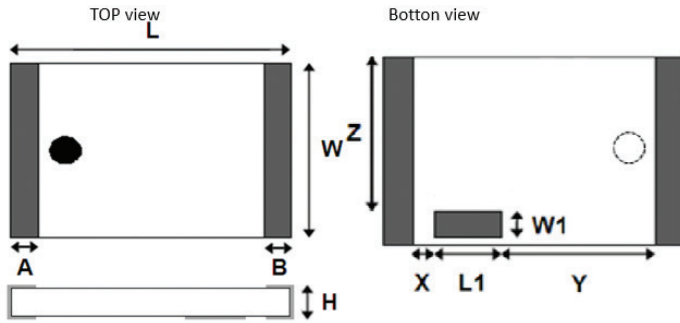

L	5.20 ± 0.30
W	3.70 ± 0.30
H	0.70 ± 0.15
A	0.50 ± 0.25
B	0.50 ± 0.25
L1	1.10 ± 0.20
W1	0.55 ± 0.20
X	0.50 ± 0.10
Y	2.60 ± 0.20
Z	2.95 ± 0.30

(Unit: mm)

## TAPING PACKAGE AND LABEL MARKING

- (1) Quantity/reel: 2000pcs/reel
- (2) Carrier tape dimensions

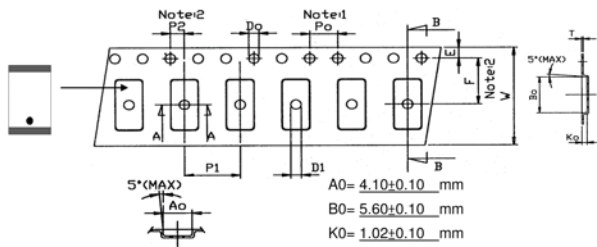

Symbol	Spec.
Po	4.00±0.1
P1	8.00±0.1
P2	2.00±0.05
Do	1.55±0.05
D1	1.50(MIN)
E	1.75±0.1
F	5.50±0.05
10Po	40.00±0.2
W	12.00±0.1
T	0.25±0.05

Notice:

1. 10 Sprocket hole pitch cumulative tolerance is ±0.1mm
2. Pocket position relative to sprocket hole measured as true position of pocket not pocket hole.
3. A0 & B0 measured on a place 0.3mm above the bottom of the pocket to top surface of the carrier.
4. K0 measured from a plane on the inside bottom of the pocket to the top surface of the carrier.
5. Carrier camber shall be not than 1mm per 100mm through a length of 250mm.

(Unit: mm)

- (3) Taping reel dimensions

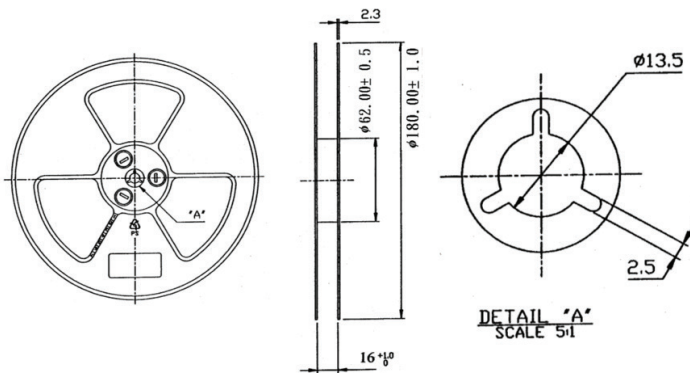

# 1570-1615 MHz GNSS Antenna, Chip Type

Standard Antenna Solutions

## RECOMMENDED REFLOW SOLDERING

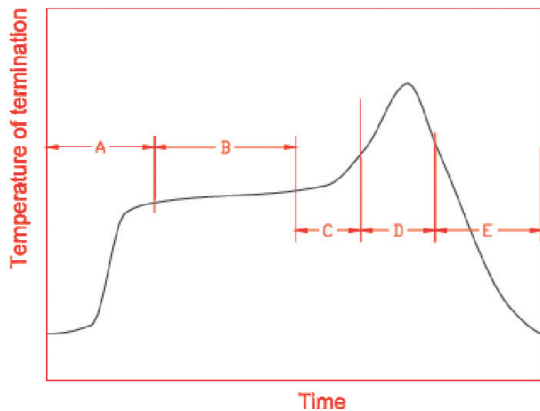

Region	Temperature Profile	Duration	
A	1 <sup>st</sup> rising temperature	The normal to Preheating temperature	
B	Preheating	140°C to 160°C	
C	2 <sup>nd</sup> rising temperature	Preheating to 200°C	
D	Main heating	if 220°C	50s~60s
		if 230°C	40s~50s
		if 240°C	30s~40s
		if 250°C	20s~40s
E	Regular cooling	200°C to 100°C	
		1°C/s ~ 4°C/s	

### (1) Soldering gun procedure

Note the following, in case of using solder gun for replacement

- (a) The tip temperature must be less than 350°C for a period within 3 seconds by using soldering gun under 30 W
- (b) The soldering gun tip shall not touch this product directly

### (2) Soldering volume

Note that excess soldering volume will easily crack the body of this product

## TE TECHNICAL SUPPORT CENTER

USA: +1 (800) 522-6752  
Canada: +1 (905) 475-6222  
Mexico: +52 (0) 55-1106-0800  
Latin/S. America +54 (0) 11-4733-2200  
Germany: +49 (0) 6251-133-1999  
UK: +44 (0) 800-267666  
France: +33 (0) 1-3420-8686  
Netherlands: +31 (0) 73-6246-999  
China: +86 (0) 400-820-6015

For phone numbers in other countries, go to [te.com/support-center](http://te.com/support-center)

## te.com

TE Connectivity, TE Connectivity (logo) and Every Connection Counts are trademarks. All other logos, products and/or company names referred to herein might be trademarks of their respective owners.

The information given herein, including drawings, illustrations and schematics which are intended for illustration purposes only, is believed to be reliable. However, TE Connectivity makes no warranties as to its accuracy or completeness and disclaims any liability in connection with its use. TE Connectivity's obligations shall only be as set forth in TE Connectivity's Standard Terms and Conditions of Sale for this product and in no case will TE Connectivity be liable for any incidental, indirect or consequential damages arising out of the sale, resale, use or misuse of the product. Users of TE Connectivity products should make their own evaluation to determine the suitability of each such product for the specific application.

© 2019 TE Connectivity Ltd. family of companies All Rights Reserved.

1-1773970-1 01/19 Original