

NOTES:

- MATERIAL:**
HOUSING: NYLON, GLASS-FILLED, UL94V-0,
COLOR: BLACK
PIN: 0.50mm SQ. COPPER ALLOY
- PLATING FINISH:**
 - 15µin MIN. GOLD PLATE IN SELECTED AREA AND 80µin MIN. TIN ON SOLDER TAIL OVER 50µin MIN. NICKEL UNDERPLATE OVERALL.
 - 30µin MIN. GOLD PLATE IN SELECTED AREA AND 80µin MIN. TIN ON SOLDER TAIL OVER 50µin MIN. NICKEL UNDERPLATE OVERALL.
 - 100µin MIN. TIN OVERALL 50µin MIN. NICKEL UNDERPLATE OVERALL.
 - 2-10µin MIN. GOLD OVER 50µin MIN. NICKEL UNDERPLATE OVERALL.
- PACKAGING: SEE TABLE
- RECOMMENDED PCB THICKNESS: 1.60±0.10mm
- PRODUCT SPECIFICATION: PS-87761-100
- WAFER TO BE FLAT WITHIN 0.003mm/mm
- 7 BEND DEPRESSION IS ACCEPTED SO LONG AS IT DOES NOT AFFECT THE OVERALL COPLANARITY OF TAIL
- 8 COPLANARITY IS TO BE MEASURED BY RESTING THE SOLDER TAIL ON A FLAT SURFACE
- 9 CAP LOCATION IS CENTERED ALONG THE MATING ENDS AS SHOWN. TOP SURFACE OF CAP TO BE FLAT FOR THE PURPOSE OF PICK & PLACE BY VACUUM SUCTION NOZZLE
- CKT 4 & 6 IS CUT FROM CKT 8 & 12 RESPECTIVELY. ROUGH EDGES ARE EXPECTED ALONG THE CUTTING EDGES
- THE ABOVE 8CKTS SHOWN IS FOR ILLUSTRATION ONLY.
- TUBE LENGTH : 560mm REF.

THIS DRAWING CONTAINS INFORMATION THAT IS PROPRIETARY TO MOLEX ELECTRONIC TECHNOLOGIES, LLC AND SHOULD NOT BE USED WITHOUT WRITTEN PERMISSION											
DIMENSION UNITS		SCALE		CURRENT REV DESC:							
mm		NTS									
GENERAL TOLERANCES (UNLESS SPECIFIED)				EC NO: 691087		DRWN: DANUSA		2022/01/06		CUSTOM HEADER 2.00MM PITCH DUAL ROW HDR, SINGLE WAFER, SMT	
				CHK'D: DANUSA		2022/01/06					
4 PLACES ±				APPR: MRAMAKRISHNA		2022/01/06		PRODUCT CUSTOMER DRAWING			
3 PLACES ±				INITIAL REVISION:		DRWN: SKLIM01		2006/03/23		DOCUMENT NUMBER	
2 PLACES ± 0.2				APPR: PATEY		2006/03/29		SD-87759-277		DOC TYPE DOC PART REVISION	
1 PLACE ±				ANGULAR TOL ± 3.0°		THIRD ANGLE PROJECTION		DRAWING		SERIES	
0 PLACES ±				DRAFT WHERE APPLICABLE MUST REMAIN WITHIN DIMENSIONS		A3-SIZE		87759		MATERIAL NUMBER	
				CUSTOMER		GENERAL MARKET		SEE TABLE		SHEET NUMBER	
										1 OF 12	

CIRCUITS POSITION CONFIGURATION

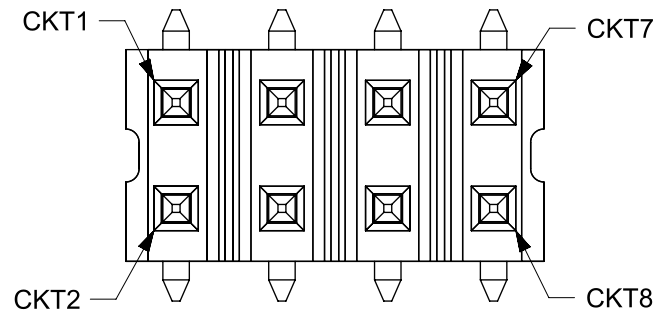

PARTS PACK IN TUBE ORIENTATION

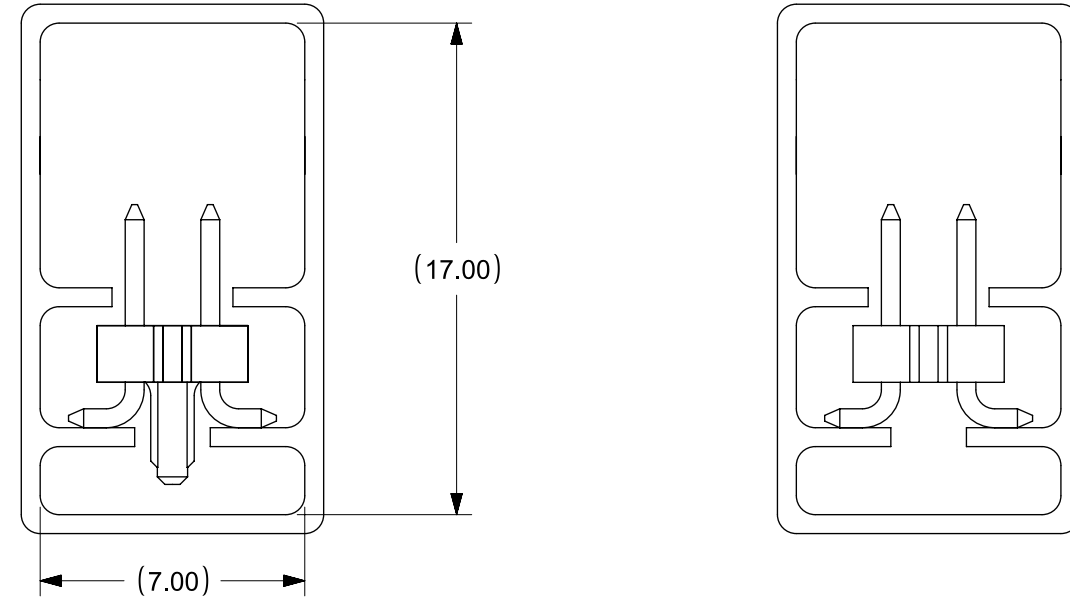

PART WITHOUT CAP IN TUBE
(PLS REFER TO PK SPEC: PK-89990-475)

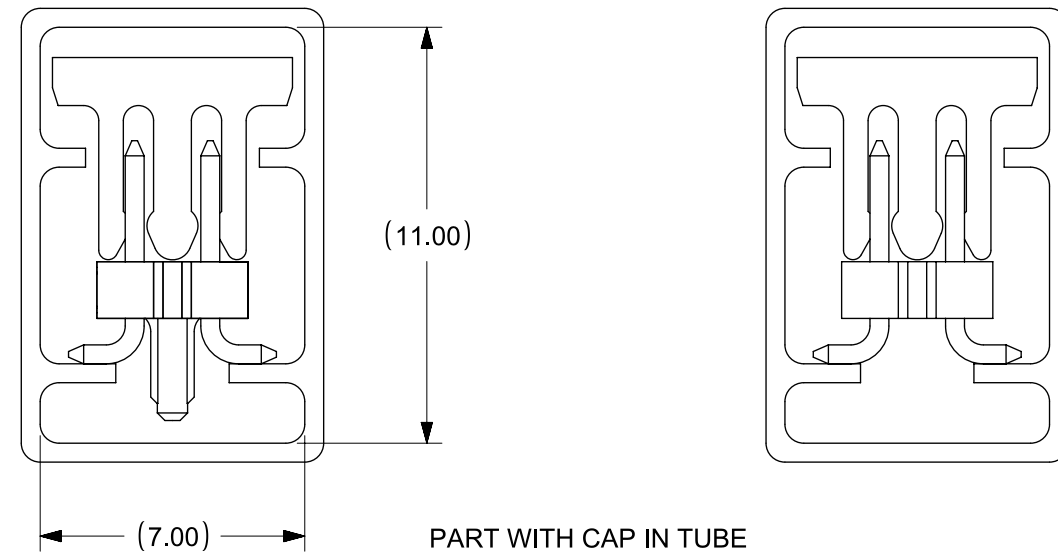

PART WITH CAP IN TUBE
(PLS REFER TO PK SPEC: PK-89990-476)

THIS DRAWING CONTAINS INFORMATION THAT IS PROPRIETARY TO MOLEX ELECTRONIC TECHNOLOGIES, LLC AND SHOULD NOT BE USED WITHOUT WRITTEN PERMISSION									
DIMENSION UNITS		SCALE		CURRENT REV DESC:				molex	
mm		NTS							
GENERAL TOLERANCES (UNLESS SPECIFIED)				EC NO: 691087		2022/01/06		CUSTOM HEADER	
				DRWN: DANUSA		2022/01/06		2.00MM PITCH DUAL ROW HDR, SINGLE WAFER, SMT	
				CHK'D: DANUSA		2022/01/06		PRODUCT CUSTOMER DRAWING	
				APPR: MRAMAKRISHNA		2022/01/06			
				INITIAL REVISION:				DOCUMENT NUMBER	
				DRWN: SKLIM01		2006/03/23		SD-87759-277	
				APPR: PATEY		2006/03/29		PSD 001 B5	
ANGULAR TOL ± 3.0°				DRAFT WHERE APPLICABLE MUST REMAIN WITHIN DIMENSIONS		THIRD ANGLE PROJECTION		DRAWING	
						SERIES		MATERIAL NUMBER	
						A3-SIZE		SEE TABLE	
						87759		CUSTOMER	
								GENERAL MARKET	
								SHEET NUMBER	
								2 OF 12	

WITH CAP IN TAPE & REEL PACKAGING
 THE 8CKTS SHOWN AS ABOVE IS FOR
 ILLUSTRATION PURPOSE ONLY.
 (THIS TYPE E/TAPE USED FOR CKT 8 TO 14)
 (PLS REFER TO PK SPEC: PK-89990-484)

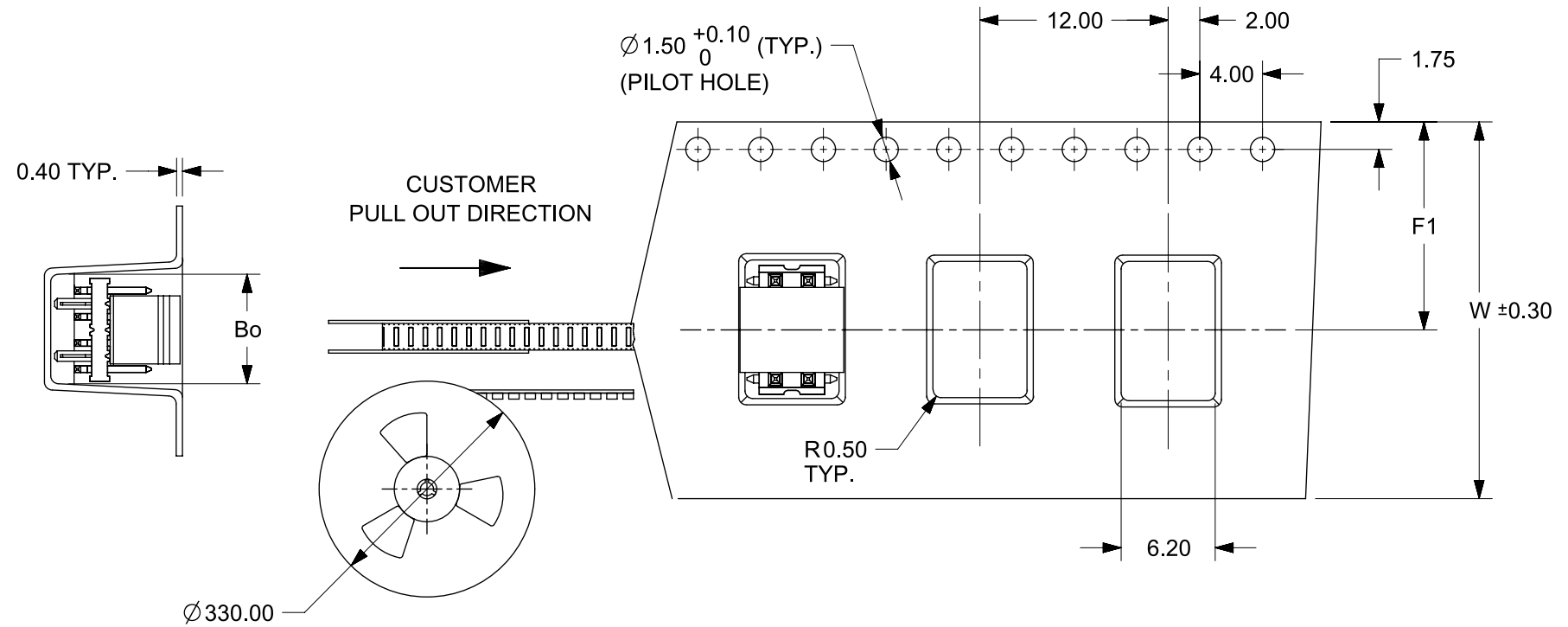

EMBOSSSED CARRIER TAPE TYPE "A"

NOTES:

1. LEADER AND TRAILER TAPE

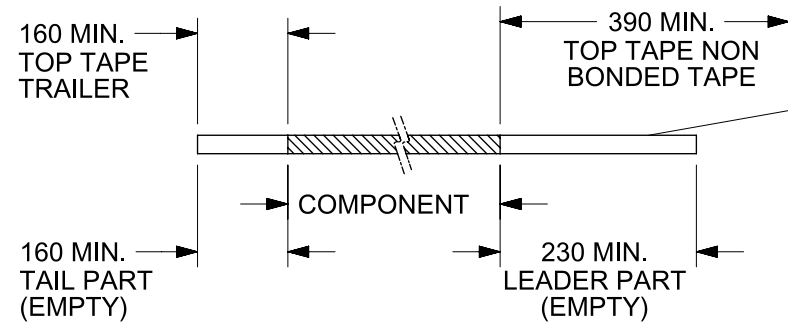

PULL OUT DIRECTION

**2. PEELING OFF FORCE OF THE TOP TAPE: 20 - 80gf.
 (PEELING DIRECTION AS SHOWN IN FOLLOWING FIGURE)**

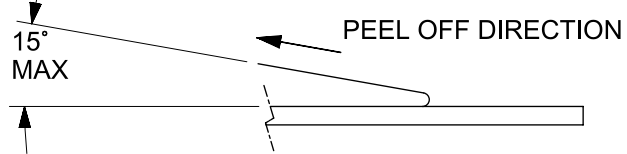

PULL OUT DIRECTION

- 3. TAPE & REEL SPECIFICATION IS AS PER EIA-481.
- 4. TAPE & REEL QUANTITY = 500 PCS/REEL
- 5. THE TAPE IS TREATED FOR ANTI-STATIC

THIS DRAWING CONTAINS INFORMATION THAT IS PROPRIETARY TO MOLEX ELECTRONIC TECHNOLOGIES, LLC AND SHOULD NOT BE USED WITHOUT WRITTEN PERMISSION		CURRENT REV DESC:		molex	
DIMENSION UNITS	SCALE	EC NO: 691087			
mm	NTS	DRWN: DANUSA 2022/01/06		CUSTOMER	
GENERAL TOLERANCES (UNLESS SPECIFIED)		CHK'D: DANUSA 2022/01/06		2.00MM PITCH DUAL ROW HDR, SINGLE WAFER, SMT	
		MM	INCH	PRODUCT CUSTOMER DRAWING	
4 PLACES	±			DOCUMENT NUMBER	
3 PLACES	±			SD-87759-277	
2 PLACES	±	0.2		DOC TYPE	DOC PART
1 PLACE	±			PSD	001
0 PLACES	±			REVISION	
ANGULAR TOL ± 3.0°		INITIAL REVISION:		B5	
DRAFT WHERE APPLICABLE MUST REMAIN WITHIN DIMENSIONS		DRWN: SKLIM01 2006/03/23		SHEET NUMBER	
THIRD ANGLE PROJECTION		APPR: PATEY 2006/03/29		3 OF 12	
DRAWING		SERIES		MATERIAL NUMBER	
A3-SIZE		87759		SEE TABLE	
CUSTOMER		GENERAL MARKET			

WITH CAP IN TAPE & REEL PACKAGING
 THE 24CKTS SHOWN ABOVE
 IS FOR ILLUSTRATION ONLY.
 (THIS TYPE E/TAPE USED FOR CKT 16 TO 50)
 (PLS REFER TO PK SPEC: PK-89990-484)

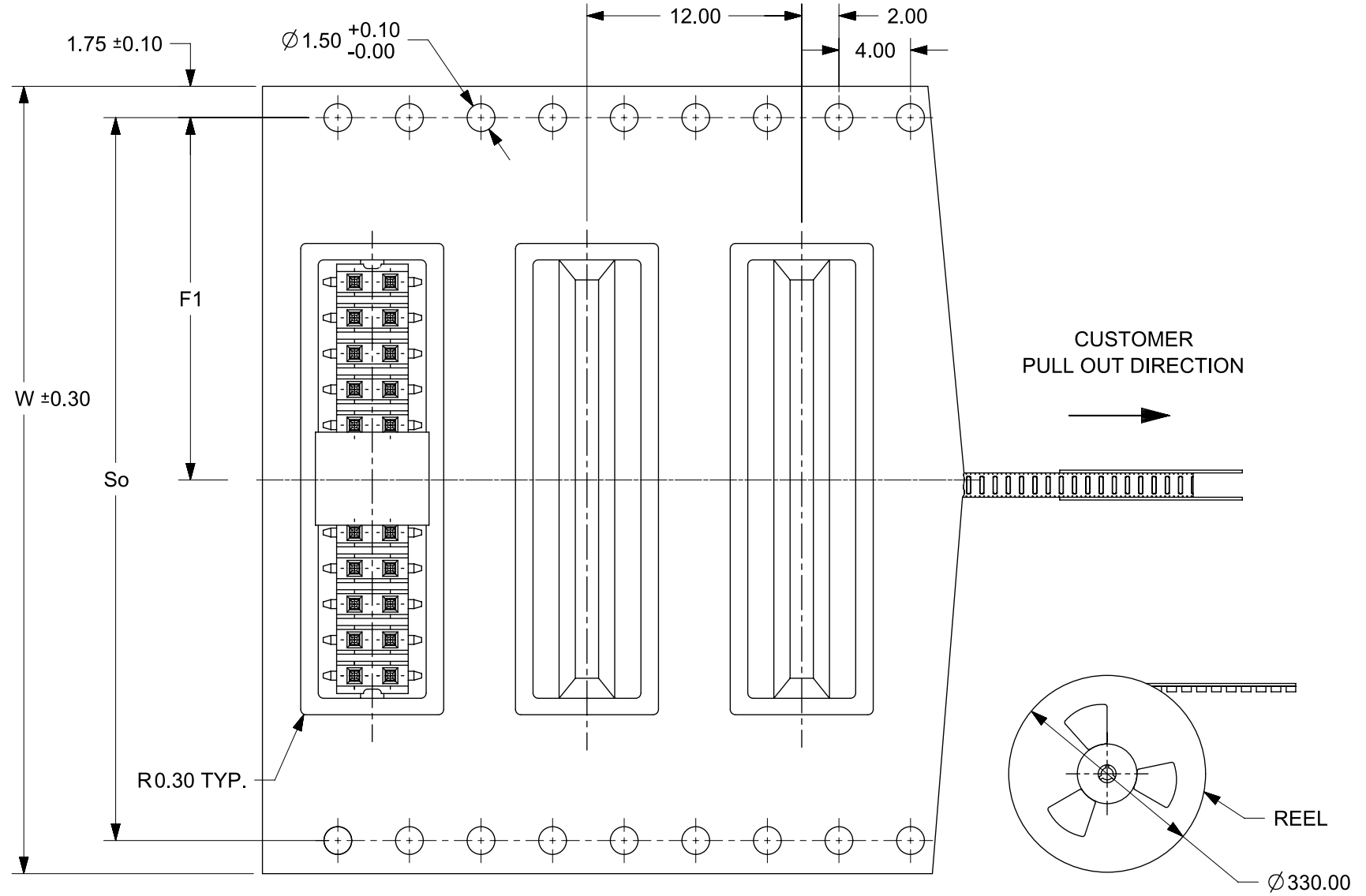
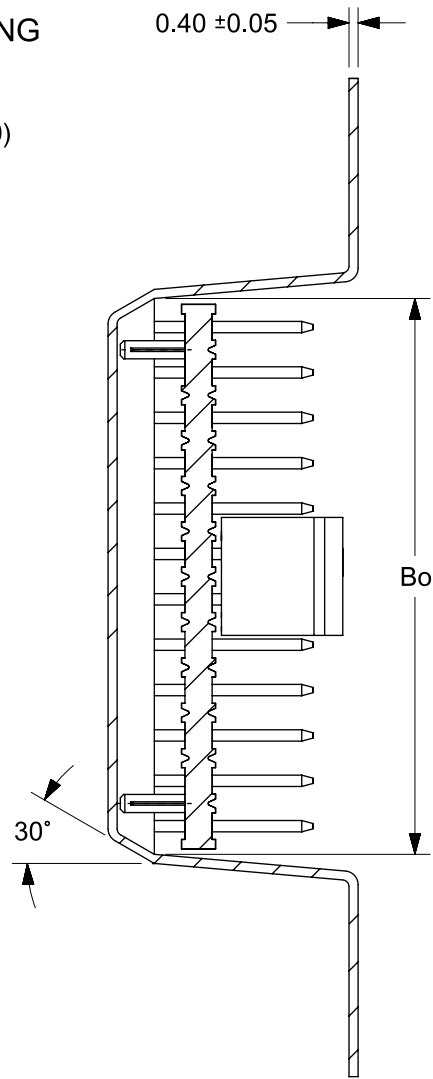

EMBOSSED CARRIER TAPE TYPE "B"

- NOTES:
 1. LEADER AND TRAILER TAPE

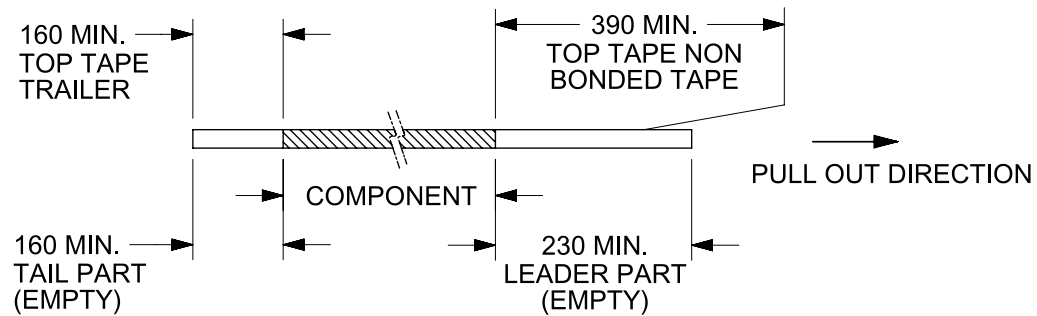

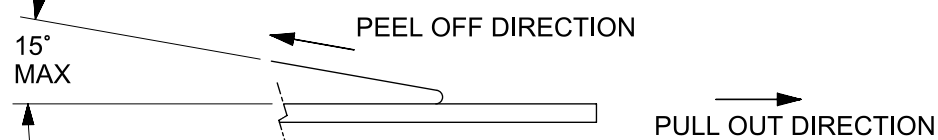

2. PEELING OFF FORCE OF THE TOP TAPE: 20 - 80gf.
 (PEELING DIRECTION AS SHOWN IN FOLLOWING FIGURE)



3. TAPE & REEL SPECIFICATION IS AS PER EIA-481.
 4. TAPE & REEL QUANTITY = 500 PCS/REEL
 5. THE TAPE IS TREATED FOR ANTI-STATIC

THIS DRAWING CONTAINS INFORMATION THAT IS PROPRIETARY TO MOLEX ELECTRONIC TECHNOLOGIES, LLC AND SHOULD NOT BE USED WITHOUT WRITTEN PERMISSION											
DIMENSION UNITS		SCALE		CURRENT REV DESC:							
mm		NTS									
GENERAL TOLERANCES (UNLESS SPECIFIED)				EC NO: 691087		DRWN: DANUSA		2022/01/06		CUSTOMER	
				CHK'D: DANUSA		2022/01/06		2.00MM PITCH DUAL ROW HDR, SINGLE WAFER, SMT			
				APPR: MRAMAKRISHNA		2022/01/06		PRODUCT CUSTOMER DRAWING			
4 PLACES ±				INITIAL REVISION:		DRWN: SKLIM01		DOCUMENT NUMBER		DOC TYPE	
3 PLACES ±				2006/03/23		2006/03/29		SD-87759-277		PSD	
2 PLACES ± 0.2				APPR: PATEY				001		B5	
1 PLACE ±				THIRD ANGLE PROJECTION		DRAWING		SERIES		SHEET NUMBER	
0 PLACES ±				DRAFT WHERE APPLICABLE MUST REMAIN WITHIN DIMENSIONS		A3-SIZE		87759		4 OF 12	
ANGULAR TOL ± 3.0°				MATERIAL NUMBER		CUSTOMER		SEE TABLE		GENERAL MARKET	

10	9	8	7	6	5	4	3	2	1										
PART NUMBER WITHOUT CAP IN TRAY	PART NUMBER WITHOUT CAP IN TUBE	PART NUMBER WITH CAP IN TUBE	PART NUMBER WITH CAP IN TAPE & REEL	CKT SIZE	PEG	PLATING TYPE	VOID POSITION	A	B	C	M	(F)	(G)	Bo	F1	So	W	EMBOSSED TYPE	
F	87759-0461	----	----	4	N	1	----	3.90	2.00	---	3.20	5.90	8.10	---	---	---	---	---	
	87759-0462	----	----	4	N	2	----	3.90	2.00	---	3.20	5.90	8.10	---	---	---	---	---	
	87759-0463	----	87759-0493	4	N	3	----	3.90	2.00	---	3.20	5.90	8.10	---	---	---	---	---	
	87759-0661	----	----	6	N	1	----	7.90	6.00	---	3.20	5.90	8.10	---	---	---	---	---	
E	87759-0662	----	----	6	N	2	----	7.90	6.00	---	3.20	5.90	8.10	---	---	---	---	---	
	87759-0663	----	----	6	N	3	----	7.90	6.00	---	3.20	5.90	8.10	---	---	---	---	---	
	----	87759-0861	87759-0871	87759-0881	8	N	1	----	7.90	6.00	---	3.20	5.90	8.10	8.50	11.50	---	24.00	A
	----	87759-0862	87759-0872	87759-0882	8	N	2	----	7.90	6.00	---	3.20	5.90	8.10	8.50	11.50	---	24.00	A
	----	87759-0863	87759-0873	87759-0883	8	N	3	----	7.90	6.00	---	3.20	5.90	8.10	8.50	11.50	---	24.00	A
D	----	87759-6081	87759-7081	87759-8081	8	Y	1	----	7.90	6.00	4.00	3.20	5.90	8.10	8.50	11.50	---	24.00	A
	----	87759-6082	87759-7082	87759-8082	8	Y	2	----	7.90	6.00	4.00	3.20	5.90	8.10	8.50	11.50	---	24.00	A
	----	87759-6083	87759-7083	87759-8083	8	Y	3	----	7.90	6.00	4.00	3.20	5.90	8.10	8.50	11.50	---	24.00	A

10	9	8	7	6	5	4	3	2	1																																																																																																																																			
C																																																																																																																																												
B																																																																																																																																												
A																																																																																																																																												
<table border="1"> <tr> <td colspan="10">THIS DRAWING CONTAINS INFORMATION THAT IS PROPRIETARY TO MOLEX ELECTRONIC TECHNOLOGIES, LLC AND SHOULD NOT BE USED WITHOUT WRITTEN PERMISSION</td> </tr> <tr> <td colspan="2">DIMENSION UNITS</td> <td colspan="2">SCALE</td> <td colspan="6">CURRENT REV DESC:</td> <td colspan="2" rowspan="2">  </td> </tr> <tr> <td colspan="2">mm</td> <td colspan="2">NTS</td> <td colspan="6" rowspan="5"> EC NO: 691087 DRWN: DANUSA 2022/01/06 CHK'D: DANUSA 2022/01/06 APPR: MRAMAKRISHNA 2022/01/06 INITIAL REVISION: DRWN: SKLIM01 2006/03/23 APPR: PATEY 2006/03/29 </td> <td colspan="2">DOCUMENT NUMBER</td> <td>DOC TYPE</td> <td>DOC PART</td> <td>REVISION</td> </tr> <tr> <td colspan="4">GENERAL TOLERANCES (UNLESS SPECIFIED)</td> <td colspan="2">MM</td> <td colspan="2">INCH</td> <td colspan="4">CUSTOMER</td> </tr> <tr> <td colspan="2">4 PLACES</td> <td>±</td> <td>±</td> <td colspan="6" rowspan="4"> PRODUCT CUSTOMER DRAWING 2.00MM PITCH DUAL ROW HDR, SINGLE WAFER, SMT </td> <td colspan="4">SD-87759-277</td> </tr> <tr> <td colspan="2">3 PLACES</td> <td>±</td> <td>±</td> <td colspan="4">SEE TABLE</td> <td colspan="2">GENERAL MARKET</td> <td colspan="2">5 OF 12</td> </tr> <tr> <td colspan="2">2 PLACES</td> <td>±</td> <td>0.2</td> <td colspan="2">DRAFT WHERE APPLICABLE MUST REMAIN WITHIN DIMENSIONS</td> <td colspan="2">THIRD ANGLE PROJECTION</td> <td colspan="2">DRAWING</td> <td colspan="2">SERIES</td> <td colspan="2">MATERIAL NUMBER</td> </tr> <tr> <td colspan="2">1 PLACE</td> <td>±</td> <td>±</td> <td colspan="2">A3-SIZE</td> <td colspan="2">87759</td> <td colspan="2">SEE TABLE</td> <td colspan="2">GENERAL MARKET</td> <td colspan="2">5 OF 12</td> </tr> <tr> <td colspan="2">0 PLACES</td> <td>±</td> <td>±</td> <td colspan="2"></td> <td colspan="2"></td> <td colspan="2"></td> <td colspan="2"></td> <td colspan="2"></td> </tr> <tr> <td colspan="2">ANGULAR TOL</td> <td colspan="2">± 3.0°</td> <td colspan="6"></td> <td colspan="2"></td> <td colspan="2"></td> </tr> </table>										THIS DRAWING CONTAINS INFORMATION THAT IS PROPRIETARY TO MOLEX ELECTRONIC TECHNOLOGIES, LLC AND SHOULD NOT BE USED WITHOUT WRITTEN PERMISSION										DIMENSION UNITS		SCALE		CURRENT REV DESC:								mm		NTS		EC NO: 691087 DRWN: DANUSA 2022/01/06 CHK'D: DANUSA 2022/01/06 APPR: MRAMAKRISHNA 2022/01/06 INITIAL REVISION: DRWN: SKLIM01 2006/03/23 APPR: PATEY 2006/03/29						DOCUMENT NUMBER		DOC TYPE	DOC PART	REVISION	GENERAL TOLERANCES (UNLESS SPECIFIED)				MM		INCH		CUSTOMER				4 PLACES		±	±	PRODUCT CUSTOMER DRAWING 2.00MM PITCH DUAL ROW HDR, SINGLE WAFER, SMT						SD-87759-277				3 PLACES		±	±	SEE TABLE				GENERAL MARKET		5 OF 12		2 PLACES		±	0.2	DRAFT WHERE APPLICABLE MUST REMAIN WITHIN DIMENSIONS		THIRD ANGLE PROJECTION		DRAWING		SERIES		MATERIAL NUMBER		1 PLACE		±	±	A3-SIZE		87759		SEE TABLE		GENERAL MARKET		5 OF 12		0 PLACES		±	±											ANGULAR TOL		± 3.0°											
THIS DRAWING CONTAINS INFORMATION THAT IS PROPRIETARY TO MOLEX ELECTRONIC TECHNOLOGIES, LLC AND SHOULD NOT BE USED WITHOUT WRITTEN PERMISSION																																																																																																																																												
DIMENSION UNITS		SCALE		CURRENT REV DESC:																																																																																																																																								
mm		NTS		EC NO: 691087 DRWN: DANUSA 2022/01/06 CHK'D: DANUSA 2022/01/06 APPR: MRAMAKRISHNA 2022/01/06 INITIAL REVISION: DRWN: SKLIM01 2006/03/23 APPR: PATEY 2006/03/29								DOCUMENT NUMBER		DOC TYPE	DOC PART	REVISION																																																																																																																												
GENERAL TOLERANCES (UNLESS SPECIFIED)										MM		INCH		CUSTOMER																																																																																																																														
4 PLACES		±	±							PRODUCT CUSTOMER DRAWING 2.00MM PITCH DUAL ROW HDR, SINGLE WAFER, SMT						SD-87759-277																																																																																																																												
3 PLACES		±	±													SEE TABLE				GENERAL MARKET		5 OF 12																																																																																																																						
2 PLACES		±	0.2													DRAFT WHERE APPLICABLE MUST REMAIN WITHIN DIMENSIONS		THIRD ANGLE PROJECTION		DRAWING		SERIES		MATERIAL NUMBER																																																																																																																				
1 PLACE		±	±	A3-SIZE		87759		SEE TABLE								GENERAL MARKET		5 OF 12																																																																																																																										
0 PLACES		±	±																																																																																																																																									
ANGULAR TOL		± 3.0°																																																																																																																																										
<table border="1"> <tr> <td>DOCUMENT STATUS</td> <td>P1</td> <td>RELEASE DATE</td> <td>2022/01/06</td> <td>11:54:31</td> <td colspan="5"></td> </tr> </table>										DOCUMENT STATUS	P1	RELEASE DATE	2022/01/06	11:54:31																																																																																																																														
DOCUMENT STATUS	P1	RELEASE DATE	2022/01/06	11:54:31																																																																																																																																								

10		9		8		7		6		5		4		3		2		1	
PART NUMBER WITHOUT CAP IN TUBE	PART NUMBER WITH CAP IN TUBE	PART NUMBER WITH CAP IN TAPE & REEL	PART NUMBER WITHOUT CAP IN TRAY	CKT SIZE	PEG	PLATING TYPE	VOID POSITION	A	B	C	M	(F)	(G)	Bo	F1	So	W	EMBOSSSED TYPE	
F	87759-1061	87759-1071	87759-1081	-----	10	N	1	-----	9.90	8.00	---	3.20	5.90	8.10	10.50	11.50	---	24.00	A
	87759-1062	87759-1072	87759-1082	-----	10	N	2	-----	9.90	8.00	---	3.20	5.90	8.10	10.50	11.50	---	24.00	A
	87759-1063	87759-1073	87759-1083	-----	10	N	3	-----	9.90	8.00	---	3.20	5.90	8.10	10.50	11.50	---	24.00	A
	87759-6101	87759-7101	87759-8101	-----	10	Y	1	-----	9.90	8.00	6.00	3.20	5.90	8.10	10.50	11.50	---	24.00	A
	87759-6102	87759-7102	87759-8102	-----	10	Y	2	-----	9.90	8.00	6.00	3.20	5.90	8.10	10.50	11.50	---	24.00	A
	87759-6103	87759-7103	87759-8103	-----	10	Y	3	-----	9.90	8.00	6.00	3.20	5.90	8.10	10.50	11.50	---	24.00	A
E	87759-1070	87759-7030	87759-7010	-----	10	Y	1	----	9.90	8.00	6.00	3.60	6.50	8.70	10.50	11.50	---	24.00	A
	87759-1261	87759-1271	87759-1281	-----	12	N	1	-----	11.90	10.00	---	3.20	5.90	8.10	12.50	11.50	---	24.00	A
	87759-1262	87759-1272	87759-1282	-----	12	N	2	-----	11.90	10.00	---	3.20	5.90	8.10	12.50	11.50	---	24.00	A
	87759-1263	87759-1273	87759-1283	-----	12	N	3	-----	11.90	10.00	---	3.20	5.90	8.10	12.50	11.50	---	24.00	A
	87759-6121	87759-7121	87759-8121	-----	12	Y	1	-----	11.90	10.00	---	3.20	5.90	8.10	12.50	11.50	---	24.00	A
	87759-6122	87759-7122	87759-8122	-----	12	Y	2	-----	11.90	10.00	---	3.20	5.90	8.10	12.50	11.50	---	24.00	A
D	87759-6123	87759-7123	87759-8123	-----	12	Y	3	-----	11.90	10.00	---	3.20	5.90	8.10	12.50	11.50	---	24.00	A
	----	-----	----	87759-0005	12	N	4	----	11.90	10.00	---	4.57	7.57	---	---	---	---	---	---
	87759-1461	87759-1471	87759-1481	-----	14	N	1	-----	13.90	12.00	---	3.20	5.90	8.10	14.50	11.50	---	24.00	A
	87759-1462	87759-1472	87759-1482	-----	14	N	2	-----	13.90	12.00	---	3.20	5.90	8.10	14.50	11.50	---	24.00	A
	87759-1463	87759-1473	87759-1483	-----	14	N	3	-----	13.90	12.00	---	3.20	5.90	8.10	14.50	11.50	---	24.00	A
C	87759-6141	87759-7141	87759-8141	-----	14	Y	1	-----	13.90	12.00	---	3.20	5.90	8.10	14.50	11.50	---	24.00	A
	87759-6142	87759-7142	87759-8142	-----	14	Y	2	-----	13.90	12.00	---	3.20	5.90	8.10	14.50	11.50	---	24.00	A
	87759-6143	87759-7143	87759-8143	-----	14	Y	3	-----	13.90	12.00	---	3.20	5.90	8.10	14.50	11.50	---	24.00	A
	----	-----	87759-0003	-----	14	Y	1	-----	13.90	12.00	---	4.00	6.70	8.05	14.20	11.50	---	24.00	A
	87759-1470	87759-7032	87759-7012	-----	14	Y	1	----	13.90	12.00	6.00	3.60	6.50	8.70	14.50	11.50	---	24.00	A

B																																																																																																																																																																													
A																																																																																																																																																																													
<table border="1" style="width: 100%; border-collapse: collapse;"> <tr> <td colspan="19" style="text-align: center; font-size: small;">THIS DRAWING CONTAINS INFORMATION THAT IS PROPRIETARY TO MOLEX ELECTRONIC TECHNOLOGIES, LLC AND SHOULD NOT BE USED WITHOUT WRITTEN PERMISSION</td> </tr> <tr> <td colspan="2">DIMENSION UNITS</td> <td colspan="2">SCALE</td> <td colspan="15">CURRENT REV DESC:</td> </tr> <tr> <td colspan="2" style="text-align: center;">mm</td> <td colspan="2" style="text-align: center;">NTS</td> <td colspan="15" rowspan="5" style="text-align: center; vertical-align: middle;"> <div style="display: flex; justify-content: space-between;"> <div style="width: 40%;"> <p style="font-size: 24px; margin: 0;">molex</p> <p style="margin: 0;">CUSTOM HEADER</p> <p style="margin: 0;">2.00MM PITCH DUAL ROW HDR, SINGLE WAFER, SMT</p> </div> <div style="width: 55%; text-align: right;"> <p style="margin: 0;">PRODUCT CUSTOMER DRAWING</p> <p style="margin: 0;">DOCUMENT NUMBER: SD-87759-277</p> <p style="margin: 0;">DOC TYPE: PSD DOC PART: 001 REVISION: B5</p> </div> </div> </td> </tr> <tr> <td colspan="4" style="text-align: center;">GENERAL TOLERANCES (UNLESS SPECIFIED)</td> </tr> <tr> <td colspan="2"></td> <td colspan="2" style="text-align: center;">MM</td> <td colspan="2" style="text-align: center;">INCH</td> </tr> <tr> <td colspan="2">4 PLACES</td> <td colspan="2" style="text-align: center;">±</td> <td colspan="2" style="text-align: center;">±</td> </tr> <tr> <td colspan="2">3 PLACES</td> <td colspan="2" style="text-align: center;">±</td> <td colspan="2" style="text-align: center;">±</td> </tr> <tr> <td colspan="2">2 PLACES</td> <td colspan="2" style="text-align: center;">± 0.2</td> <td colspan="2" style="text-align: center;">±</td> </tr> <tr> <td colspan="2">1 PLACE</td> <td colspan="2" style="text-align: center;">±</td> <td colspan="2" style="text-align: center;">±</td> </tr> <tr> <td colspan="2">0 PLACES</td> <td colspan="2" style="text-align: center;">±</td> <td colspan="2" style="text-align: center;">±</td> </tr> <tr> <td colspan="4">ANGULAR TOL ± 3.0°</td> <td colspan="15"> <p style="font-size: small;">EC NO: 691087</p> <p style="font-size: small;">DRWN: DANUSA 2022/01/06</p> <p style="font-size: small;">CHK'D: DANUSA 2022/01/06</p> <p style="font-size: small;">APPR: MRAMAKRISHNA 2022/01/06</p> <p style="font-size: small;">INITIAL REVISION:</p> <p style="font-size: small;">DRWN: SKLIM01 2006/03/23</p> <p style="font-size: small;">APPR: PATEY 2006/03/29</p> </td> </tr> <tr> <td colspan="4">DRAFT WHERE APPLICABLE MUST REMAIN WITHIN DIMENSIONS</td> <td colspan="2" style="text-align: center;">THIRD ANGLE PROJECTION</td> <td colspan="2" style="text-align: center;">DRAWING</td> <td colspan="2" style="text-align: center;">SERIES</td> <td colspan="2" style="text-align: center;">MATERIAL NUMBER</td> <td colspan="3" style="text-align: center;">CUSTOMER</td> <td colspan="4" style="text-align: center;">SHEET NUMBER</td> </tr> <tr> <td colspan="4"></td> <td colspan="2" style="text-align: center;"></td> <td colspan="2" style="text-align: center;">A3-SIZE</td> <td colspan="2" style="text-align: center;">87759</td> <td colspan="3" style="text-align: center;">SEE TABLE</td> <td colspan="3" style="text-align: center;">GENERAL MARKET</td> <td colspan="4" style="text-align: center;">6 OF 12</td> </tr> </table>																			THIS DRAWING CONTAINS INFORMATION THAT IS PROPRIETARY TO MOLEX ELECTRONIC TECHNOLOGIES, LLC AND SHOULD NOT BE USED WITHOUT WRITTEN PERMISSION																			DIMENSION UNITS		SCALE		CURRENT REV DESC:															mm		NTS		<div style="display: flex; justify-content: space-between;"> <div style="width: 40%;"> <p style="font-size: 24px; margin: 0;">molex</p> <p style="margin: 0;">CUSTOM HEADER</p> <p style="margin: 0;">2.00MM PITCH DUAL ROW HDR, SINGLE WAFER, SMT</p> </div> <div style="width: 55%; text-align: right;"> <p style="margin: 0;">PRODUCT CUSTOMER DRAWING</p> <p style="margin: 0;">DOCUMENT NUMBER: SD-87759-277</p> <p style="margin: 0;">DOC TYPE: PSD DOC PART: 001 REVISION: B5</p> </div> </div>															GENERAL TOLERANCES (UNLESS SPECIFIED)						MM		INCH		4 PLACES		±		±		3 PLACES		±		±		2 PLACES		± 0.2		±		1 PLACE		±		±		0 PLACES		±		±		ANGULAR TOL ± 3.0°				<p style="font-size: small;">EC NO: 691087</p> <p style="font-size: small;">DRWN: DANUSA 2022/01/06</p> <p style="font-size: small;">CHK'D: DANUSA 2022/01/06</p> <p style="font-size: small;">APPR: MRAMAKRISHNA 2022/01/06</p> <p style="font-size: small;">INITIAL REVISION:</p> <p style="font-size: small;">DRWN: SKLIM01 2006/03/23</p> <p style="font-size: small;">APPR: PATEY 2006/03/29</p>															DRAFT WHERE APPLICABLE MUST REMAIN WITHIN DIMENSIONS				THIRD ANGLE PROJECTION		DRAWING		SERIES		MATERIAL NUMBER		CUSTOMER			SHEET NUMBER										A3-SIZE		87759		SEE TABLE			GENERAL MARKET			6 OF 12			
THIS DRAWING CONTAINS INFORMATION THAT IS PROPRIETARY TO MOLEX ELECTRONIC TECHNOLOGIES, LLC AND SHOULD NOT BE USED WITHOUT WRITTEN PERMISSION																																																																																																																																																																													
DIMENSION UNITS		SCALE		CURRENT REV DESC:																																																																																																																																																																									
mm		NTS		<div style="display: flex; justify-content: space-between;"> <div style="width: 40%;"> <p style="font-size: 24px; margin: 0;">molex</p> <p style="margin: 0;">CUSTOM HEADER</p> <p style="margin: 0;">2.00MM PITCH DUAL ROW HDR, SINGLE WAFER, SMT</p> </div> <div style="width: 55%; text-align: right;"> <p style="margin: 0;">PRODUCT CUSTOMER DRAWING</p> <p style="margin: 0;">DOCUMENT NUMBER: SD-87759-277</p> <p style="margin: 0;">DOC TYPE: PSD DOC PART: 001 REVISION: B5</p> </div> </div>																																																																																																																																																																									
GENERAL TOLERANCES (UNLESS SPECIFIED)																																																																																																																																																																													
		MM																	INCH																																																																																																																																																										
4 PLACES		±																	±																																																																																																																																																										
3 PLACES		±																	±																																																																																																																																																										
2 PLACES		± 0.2		±																																																																																																																																																																									
1 PLACE		±		±																																																																																																																																																																									
0 PLACES		±		±																																																																																																																																																																									
ANGULAR TOL ± 3.0°				<p style="font-size: small;">EC NO: 691087</p> <p style="font-size: small;">DRWN: DANUSA 2022/01/06</p> <p style="font-size: small;">CHK'D: DANUSA 2022/01/06</p> <p style="font-size: small;">APPR: MRAMAKRISHNA 2022/01/06</p> <p style="font-size: small;">INITIAL REVISION:</p> <p style="font-size: small;">DRWN: SKLIM01 2006/03/23</p> <p style="font-size: small;">APPR: PATEY 2006/03/29</p>																																																																																																																																																																									
DRAFT WHERE APPLICABLE MUST REMAIN WITHIN DIMENSIONS				THIRD ANGLE PROJECTION		DRAWING		SERIES		MATERIAL NUMBER		CUSTOMER			SHEET NUMBER																																																																																																																																																														
						A3-SIZE		87759		SEE TABLE			GENERAL MARKET			6 OF 12																																																																																																																																																													

10	9	8	7	6	5	4	3	2	1									
PART NUMBER WITHOUT CAP IN TUBE	PART NUMBER WITH CAP IN TUBE	PART NUMBER WITH CAP IN TAPE & REEL	CKT SIZE	PEG	PLATING TYPE	VOID POSITION	A	B	C	M	(F)	(G)	Bo	F1	So	W	EMBOSSED TYPE	
F	87759-1661	87759-1671	87759-1681	16	N	1	----	15.90	14.00	---	3.20	5.90	8.10	16.50	14.20	28.40	32.00	B
	87759-1662	87759-1672	87759-1682	16	N	2	----	15.90	14.00	---	3.20	5.90	8.10	16.50	14.20	28.40	32.00	B
	87759-1663	87759-1673	87759-1683	16	N	3	----	15.90	14.00	---	3.20	5.90	8.10	16.50	14.20	28.40	32.00	B
	87759-6161	87759-7161	87759-8161	16	Y	1	----	15.90	14.00	---	3.20	5.90	8.10	16.50	14.20	28.40	32.00	B
	87759-6162	87759-7162	87759-8162	16	Y	2	----	15.90	14.00	---	3.20	5.90	8.10	16.50	14.20	28.40	32.00	B
	87759-6163	87759-7163	87759-8163	16	Y	3	----	15.90	14.00	---	3.20	5.90	8.10	16.50	14.20	28.40	32.00	B
E	87759-1611	87759-1612	87759-1613	16	N	4	----	15.90	14.00	---	5.50	8.20	9.60	16.50	14.20	28.40	32.00	B
	87759-1670	87759-7033	87759-7013	16	Y	1	----	15.90	14.00	12.20	3.60	6.50	8.70	16.50	16.50	28.40	28.40	B
	87759-6737	877596707	87759-1667	16	Y	1	----	15.90	14.00	12.00	6.80	9.50	10.83	16.40	14.20	28.40	32.00	B
	87759-1861	87759-1871	87759-1881	18	N	1	----	17.90	16.00	---	3.20	5.90	8.10	18.50	14.20	28.40	32.00	B
	87759-1862	87759-1872	87759-1882	18	N	2	----	17.90	16.00	---	3.20	5.90	8.10	18.50	14.20	28.40	32.00	B
	87759-1863	87759-1873	87759-1883	18	N	3	----	17.90	16.00	---	3.20	5.90	8.10	18.50	14.20	28.40	32.00	B
D	87759-6181	87759-7181	87759-8181	18	Y	1	----	17.90	16.00	---	3.20	5.90	8.10	18.50	14.20	28.40	32.00	B
	87759-6182	87759-7182	87759-8182	18	Y	2	----	17.90	16.00	---	3.20	5.90	8.10	18.50	14.20	28.40	32.00	B
	87759-6183	87759-7183	87759-8183	18	Y	3	----	17.90	16.00	---	3.20	5.90	8.10	18.50	14.20	28.40	32.00	B
	----	87759-0002	87759-0001	18	Y	1	----	17.90	16.00	14.00	10.30	13.00	14.31	18.40	20.20	40.40	44.00	B
		87759-1820	87759-1820	18	N	4	---	17.90	16.00	---	8.40	11.10	12.47	18.40	20.20	40.40	44.00	B
C	87759-2061	87759-2071	87759-2081	20	N	1	----	19.90	18.00	---	3.20	5.90	8.10	20.50	20.20	40.40	44.00	B
	87759-2062	87759-2072	87759-2082	20	N	2	----	19.90	18.00	---	3.20	5.90	8.10	20.50	20.20	40.40	44.00	B
	87759-2063	87759-2073	87759-2083	20	N	3	----	19.90	18.00	---	3.20	5.90	8.10	20.50	20.20	40.40	44.00	B
	87759-6201	87759-7201	87759-8201	20	Y	1	----	19.90	18.00	---	3.20	5.90	8.10	20.50	20.20	40.40	44.00	B
	87759-6202	87759-7202	87759-8202	20	Y	2	----	19.90	18.00	---	3.20	5.90	8.10	20.50	20.20	40.40	44.00	B

<p>THIS DRAWING CONTAINS INFORMATION THAT IS PROPRIETARY TO MOLEX ELECTRONIC TECHNOLOGIES, LLC AND SHOULD NOT BE USED WITHOUT WRITTEN PERMISSION</p>										DIMENSION UNITS mm		SCALE NTS		CURRENT REV DESC:											
										GENERAL TOLERANCES (UNLESS SPECIFIED)												EC NO: 691087		DRWN: DANUSA 2022/01/06	
										4 PLACES ±		±		CHK'D: DANUSA 2022/01/06		APPR: MRAMAKRISHNA 2022/01/06		PRODUCT CUSTOMER DRAWING							
										3 PLACES ±		±		INITIAL REVISION:				DOCUMENT NUMBER		DOC TYPE		DOC PART		REVISION	
										2 PLACES ±		0.2 ±		DRWN: SKLIM01 2006/03/23				SD-87759-277		PSD		001		B5	
										1 PLACE ±		±		APPR: PATEY 2006/03/29				MATERIAL NUMBER		CUSTOMER		SHEET NUMBER			
										0 PLACES ±		±		ANGULAR TOL ± 3.0°				SEE TABLE		GENERAL MARKET		7 OF 12			
										DRAFT WHERE APPLICABLE MUST REMAIN WITHIN DIMENSIONS				THIRD ANGLE PROJECTION		DRAWING		SERIES		A3-SIZE		87759			
										DOCUMENT STATUS		P1		RELEASE DATE		2022/01/06		11:54:31							

10	9	8	7	6	5	4	3	2	1									
PART NUMBER WITHOUT CAP IN TUBE	PART NUMBER WITH CAP IN TUBE	PART NUMBER WITH CAP IN TAPE & REEL	CKT SIZE	PEG	PLATING TYPE	VOID POSITION	A	B	C	M	(F)	(G)	Bo	F1	So	W	EMBOSSED TYPE	
F	87759-6203	87759-7203	87759-8203	20	Y	3	-----	19.90	18.00	---	3.20	5.90	8.10	20.50	20.20	40.40	44.00	B
	-----	87759-8053	87759-8054	20	N	2	-----	19.90	18.00	----	3.80	6.50	8.70	20.20	14.20	28.40	32.00	B
	-----	87759-0019	87759-0020	20	Y	1	-----	19.90	18.00	16.00	3.20	5.90	8.05	20.50	20.20	40.40	44.00	B
	87759-5801	87759-5802	87759-2058	20	Y	1	-----	19.90	18.00	16.00	4.30	7.00	8.31	20.50	14.20	28.40	32.00	B
	87759-2261	87759-2271	87759-2281	22	N	1	-----	21.90	20.00	---	3.20	5.90	8.10	22.50	20.20	40.40	44.00	B
E	87759-2262	87759-2272	87759-2282	22	N	2	-----	21.90	20.00	---	3.20	5.90	8.10	22.50	20.20	40.40	44.00	B
	87759-2263	87759-2273	87759-2283	22	N	3	-----	21.90	20.00	---	3.20	5.90	8.10	22.50	20.20	40.40	44.00	B
	87759-6221	87759-7221	87759-8221	22	Y	1	-----	21.90	20.00	---	3.20	5.90	8.10	22.50	20.20	40.40	44.00	B
	87759-6222	87759-7222	87759-8222	22	Y	2	-----	21.90	20.00	---	3.20	5.90	8.10	22.50	20.20	40.40	44.00	B
	87759-6223	87759-7223	87759-8223	22	Y	3	-----	21.90	20.00	---	3.20	5.90	8.10	22.50	20.20	40.40	44.00	B
	87759-2461	87759-2471	87759-2481	24	N	1	-----	23.90	22.00	---	3.20	5.90	8.10	24.50	20.20	40.40	44.00	B
D	87759-2462	87759-2472	87759-2482	24	N	2	-----	23.90	22.00	---	3.20	5.90	8.10	24.50	20.20	40.40	44.00	B
	87759-2463	87759-2473	87759-2483	24	N	3	-----	23.90	22.00	---	3.20	5.90	8.10	24.50	20.20	40.40	44.00	B
	87759-6241	87759-7241	87759-8241	24	Y	1	-----	23.90	22.00	---	3.20	5.90	8.10	24.50	20.20	40.40	44.00	B
	87759-6242	87759-7242	87759-8242	24	Y	2	-----	23.90	22.00	---	3.20	5.90	8.10	24.50	20.20	40.40	44.00	B
	87759-6243	87759-7243	87759-8243	24	Y	3	-----	23.90	22.00	---	3.20	5.90	8.10	24.50	20.20	40.40	44.00	B
	87759-2661	87759-2671	87759-2681	26	N	1	-----	25.90	24.00	---	3.20	5.90	8.10	26.50	20.20	40.40	44.00	B
C	87759-2662	87759-2672	87759-2682	26	N	2	-----	25.90	24.00	---	3.20	5.90	8.10	26.50	20.20	40.40	44.00	B
	87759-2663	87759-2673	87759-2683	26	N	3	-----	25.90	24.00	---	3.20	5.90	8.10	26.50	20.20	40.40	44.00	B
	87759-6261	87759-7261	87759-8261	26	Y	1	-----	25.90	24.00	---	3.20	5.90	8.10	26.50	20.20	40.40	44.00	B
	87759-6262	87759-7262	87759-8262	26	Y	2	-----	25.90	24.00	---	3.20	5.90	8.10	26.50	20.20	40.40	44.00	B
	87759-6263	87759-7263	87759-8263	26	Y	3	-----	25.90	24.00	---	3.20	5.90	8.10	26.50	20.20	40.40	44.00	B

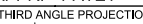
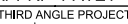
B										A																																																	
<p>THIS DRAWING CONTAINS INFORMATION THAT IS PROPRIETARY TO MOLEX ELECTRONIC TECHNOLOGIES, LLC AND SHOULD NOT BE USED WITHOUT WRITTEN PERMISSION</p> <table border="1"> <tr> <td>DIMENSION UNITS</td> <td>SCALE</td> <td colspan="2">CURRENT REV DESC:</td> </tr> <tr> <td>mm</td> <td>NTS</td> <td colspan="2"></td> </tr> <tr> <td colspan="4">GENERAL TOLERANCES (UNLESS SPECIFIED)</td> </tr> <tr> <td></td> <td>MM</td> <td>INCH</td> <td></td> </tr> <tr> <td>4 PLACES</td> <td>±</td> <td></td> <td>±</td> </tr> <tr> <td>3 PLACES</td> <td>±</td> <td></td> <td>±</td> </tr> <tr> <td>2 PLACES</td> <td>±</td> <td>0.2</td> <td>±</td> </tr> <tr> <td>1 PLACE</td> <td>±</td> <td></td> <td>±</td> </tr> <tr> <td>0 PLACES</td> <td>±</td> <td></td> <td>±</td> </tr> <tr> <td>ANGULAR TOL</td> <td>±</td> <td>3.0°</td> <td></td> </tr> </table>										DIMENSION UNITS	SCALE	CURRENT REV DESC:		mm	NTS			GENERAL TOLERANCES (UNLESS SPECIFIED)					MM	INCH		4 PLACES	±		±	3 PLACES	±		±	2 PLACES	±	0.2	±	1 PLACE	±		±	0 PLACES	±		±	ANGULAR TOL	±	3.0°		<p>EC NO: 691087 DRWN: DANUSA 2022/01/06 CHK'D: DANUSA 2022/01/06 APPR: MRAMAKRISHNA 2022/01/06</p> <p>INITIAL REVISION: DRWN: SKLIM01 2006/03/23 APPR: PATEY 2006/03/29</p> <p>THIRD ANGLE PROJECTION </p> <p>DRAFT WHERE APPLICABLE MUST REMAIN WITHIN DIMENSIONS</p>									
DIMENSION UNITS	SCALE	CURRENT REV DESC:																																																									
mm	NTS																																																										
GENERAL TOLERANCES (UNLESS SPECIFIED)																																																											
	MM	INCH																																																									
4 PLACES	±		±																																																								
3 PLACES	±		±																																																								
2 PLACES	±	0.2	±																																																								
1 PLACE	±		±																																																								
0 PLACES	±		±																																																								
ANGULAR TOL	±	3.0°																																																									
<p>DOCUMENT STATUS P1 RELEASE DATE 2022/01/06 11:54:31</p>										<p>  CUSTOM HEADER 2.00MM PITCH DUAL ROW HDR, SINGLE WAFER, SMT PRODUCT CUSTOMER DRAWING DOCUMENT NUMBER: SD-87759-277 DOC TYPE: PSD DOC PART: 001 REVISION: B5 MATERIAL NUMBER: SEE TABLE CUSTOMER: GENERAL MARKET SHEET NUMBER: 8 OF 12 </p>																																																	

10	9	8	7	6	5	4	3	2	1									
PART NUMBER WITHOUT CAP IN TUBE	PART NUMBER WITH CAP IN TUBE	PART NUMBER WITH CAP IN TAPE & REEL	CKT SIZE	PEG	PLATING TYPE	VOID POSITION	A	B	C	M	(F)	(G)	Bo	F1	So	W	EMBOSSSED TYPE	
F	87759-4661	87759-4671	87759-4681	46	N	1	----	45.90	44.00	---	3.20	5.90	8.10	46.50	34.20	68.40	72.00	B
	87759-4662	87759-4672	87759-4682	46	N	2	----	45.90	44.00	---	3.20	5.90	8.10	46.50	34.20	68.40	72.00	B
	87759-4663	87759-4673	87759-4683	46	N	3	----	45.90	44.00	---	3.20	5.90	8.10	46.50	34.20	68.40	72.00	B
	87759-6461	87759-7461	87759-8461	46	Y	1	----	45.90	44.00	---	3.20	5.90	8.10	46.50	34.20	68.40	72.00	B
	87759-6462	87759-7462	87759-8462	46	Y	2	----	45.90	44.00	---	3.20	5.90	8.10	46.50	34.20	68.40	72.00	B
E	87759-6463	87759-7463	87759-8463	46	Y	3	----	45.90	44.00	---	3.20	5.90	8.10	46.50	34.20	68.40	72.00	B
	87759-4861	87759-4871	87759-4881	48	N	1	----	47.90	46.00	---	3.20	5.90	8.10	48.50	34.20	68.40	72.00	B
	87759-4862	87759-4872	87759-4882	48	N	2	----	47.90	46.00	---	3.20	5.90	8.10	48.50	34.20	68.40	72.00	B
	87759-4863	87759-4873	87759-4883	48	N	3	----	47.90	46.00	---	3.20	5.90	8.10	48.50	34.20	68.40	72.00	B
	87759-6481	87759-7481	87759-8481	48	Y	1	----	47.90	46.00	---	3.20	5.90	8.10	48.50	34.20	68.40	72.00	B
D	87759-6482	87759-7482	87759-8482	48	Y	2	----	47.90	46.00	---	3.20	5.90	8.10	48.50	34.20	68.40	72.00	B
	87759-6483	87759-7483	87759-8483	48	Y	3	----	47.90	46.00	---	3.20	5.90	8.10	48.50	34.20	68.40	72.00	B
	87759-5061	87759-5071	87759-5081	50	N	1	----	49.90	48.00	---	3.20	5.90	8.10	50.50	34.20	68.40	72.00	B
	87759-5062	87759-5072	87759-5082	50	N	2	----	49.90	48.00	---	3.20	5.90	8.10	50.50	34.20	68.40	72.00	B
	87759-5063	87759-5073	87759-5083	50	N	3	----	49.90	48.00	---	3.20	5.90	8.10	50.50	34.20	68.40	72.00	B
C	87759-6501	87759-7501	87759-8501	50	Y	1	----	49.90	48.00	---	3.20	5.90	8.10	50.50	34.20	68.40	72.00	B
	87759-6502	87759-7502	87759-8502	50	Y	2	----	49.90	48.00	---	3.20	5.90	8.10	50.50	34.20	68.40	72.00	B
	87759-6503	87759-7503	87759-8503	50	Y	3	----	49.90	48.00	---	3.20	5.90	8.10	50.50	34.20	68.40	72.00	B

THIS DRAWING CONTAINS INFORMATION THAT IS PROPRIETARY TO MOLEX ELECTRONIC TECHNOLOGIES, LLC AND SHOULD NOT BE USED WITHOUT WRITTEN PERMISSION															
DIMENSION UNITS		SCALE		CURRENT REV DESC:				 CUSTOMER HEADER 2.00MM PITCH DUAL ROW HDR, SINGLE WAFER, SMT							
mm		NTS													
GENERAL TOLERANCES (UNLESS SPECIFIED)				EC NO: 691087				PRODUCT CUSTOMER DRAWING							
				DRWN: DANUSA 2022/01/06											
				CHK'D: DANUSA 2022/01/06				DOCUMENT NUMBER: SD-87759-277 DOC TYPE: PSD DOC PART: 001 REVISION: B5							
				APPR: MRAMAKRISHNA 2022/01/06											
				INITIAL REVISION:				MATERIAL NUMBER: SEE TABLE CUSTOMER: GENERAL MARKET SHEET NUMBER: 12 OF 12							
				DRWN: SKLIM01 2006/03/23											
				APPR: PATEY 2006/03/29											
ANGULAR TOL ± 3.0°				THIRD ANGLE PROJECTION		DRAWING		SERIES		MATERIAL NUMBER		CUSTOMER		SHEET NUMBER	
DRAFT WHERE APPLICABLE MUST REMAIN WITHIN DIMENSIONS						A3-SIZE		87759		SEE TABLE		GENERAL MARKET		12 OF 12	