

N-Channel Power MOSFET

800V, 4A, 3.0Ω

FEATURES

- Low $R_{DS(ON)}$ 3Ω (Max.)
- Low gate charge typical @ 20nC (Typ.)
- Improve dV/dt capability

APPLICATION

- Power Supply
- Lighting

KEY PERFORMANCE PARAMETERS		
PARAMETER	VALUE	UNIT
V_{DS}	800	V
$R_{DS(on)}$ (max)	3.0	Ω
Q_g	20	nC

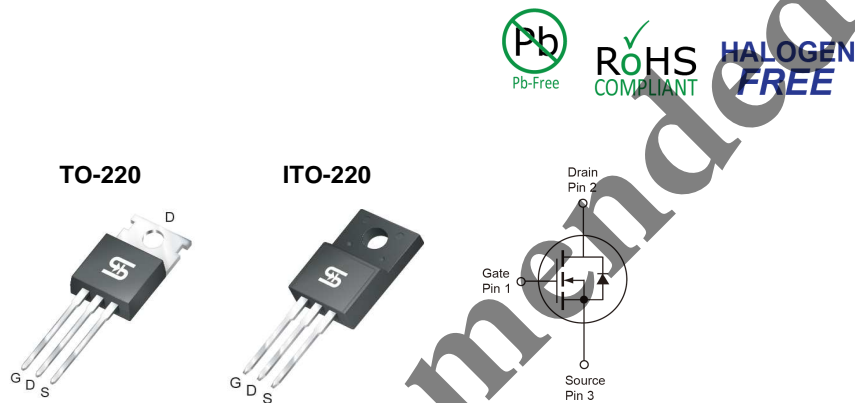

ABSOLUTE MAXIMUM RATINGS ($T_A = 25^\circ\text{C}$ unless otherwise noted)				
PARAMETER	SYMBOL	TO-220	ITO-220	UNIT
Drain-Source Voltage	V_{DS}	800		V
Gate-Source Voltage	V_{GS}	±30		V
Continuous Drain Current ^(Note 4)	I_D	$T_C = 25^\circ\text{C}$	4	A
		$T_C = 100^\circ\text{C}$	2.5	
Pulsed Drain Current ^(Note 2)	I_{DM}	16		A
Total Power Dissipation @ $T_C = 25^\circ\text{C}$	P_{DTOT}	123	38.7	W
Single Pulsed Avalanche Energy ^(Note 3)	E_{AS}	76		mJ
Single Pulsed Avalanche Current ^(Note 3)	I_{AS}	4		A
Repetitive Avalanche Energy	E_{AR}	12.3		mJ
Peak Diode Recovery ^(Note 7)	dV/dt	4.5		V
Operating Junction and Storage Temperature Range	T_J, T_{STG}	- 55 to +150		°C

THERMAL PERFORMANCE				
PARAMETER	SYMBOL	TO-220	ITO-220	UNIT
Junction to Case Thermal Resistance	$R_{\theta JC}$	1.01	3.23	°C/W
Junction to Ambient Thermal Resistance	$R_{\theta JA}$	62.5		°C/W

Notes: $R_{\theta JA}$ is the sum of the junction-to-case and case-to-ambient thermal resistances. The case thermal reference is defined at the solder mounting surface of the drain pins. $R_{\theta JA}$ is guaranteed by design while $R_{\theta CA}$ is determined by the user's board design. $R_{\theta JA}$ shown below for single device operation on FR-4 PCB in still air.

ELECTRICAL SPECIFICATIONS ($T_A = 25^\circ\text{C}$ unless otherwise noted)						
PARAMETER	CONDITIONS	SYMBOL	MIN	TYP	MAX	UNIT
Static (Note 4)						
Drain-Source Breakdown Voltage	$V_{GS} = 0V, I_D = 250\mu A$	BV_{DSS}	800	--	--	V
Gate Threshold Voltage	$V_{DS} = V_{GS}, I_D = 250\mu A$	$V_{GS(TH)}$	2.0	--	4.0	V
Gate Body Leakage	$V_{GS} = \pm 30V, V_{DS} = 0V$	I_{GSS}	--	--	± 100	nA
Zero Gate Voltage Drain Current	$V_{DS} = 700V, V_{GS} = 0V$	I_{DSS}	--	--	10	μA
Drain-Source On-State Resistance	$V_{GS} = 10V, I_D = 1.2A$	$R_{DS(on)}$	--	2.5	3.0	Ω
Forward Transconductance	$V_{DS} = 30V, I_D = 1.2A$	g_{fs}	--	7.1	--	S
Dynamic (Note 5)						
Total Gate Charge	$V_{DS} = 640V, I_D = 4.0A,$ $V_{GS} = 10V$	Q_g	--	20	--	nC
Gate-Source Charge		Q_{gs}	--	3.7	--	
Gate-Drain Charge		Q_{gd}	--	8.2	--	
Input Capacitance	$V_{DS} = 25V, V_{GS} = 0V,$ $f = 1.0MHz$	C_{iss}	--	955	--	pF
Output Capacitance		C_{oss}	--	80	--	
Reverse Transfer Capacitance		C_{rss}	--	13	--	
Gate Resistance	$F = 1MHz, \text{open drain}$	R_g	--	--	3	Ω
Switching (Note 6)						
Turn-On Delay Time	$V_{DD} = 400V,$ $R_{GEN} = 25\Omega,$ $I_D = 4.0A, V_{GS} = 10V,$	$t_{d(on)}$	--	49	--	ns
Turn-On Rise Time		t_r	--	38	--	
Turn-Off Delay Time		$t_{d(off)}$	--	146	--	
Turn-Off Fall Time		t_f	--	50	--	
Source-Drain Diode (Note 4)						
Forward On Voltage	$I_S = 4.0A, V_{GS} = 0V$	V_{SD}	--	--	1.5	V
Reverse Recovery Time	$V_{GS} = 0V, I_S = 4A$ $dI_F/dt = 100A/\mu s$	t_{rr}	--	487	--	ns
Reverse Recovery Charge		Q_{rr}	--	2.8	--	μC

Notes:

1. Current limited by package
2. Pulse width limited by the maximum junction temperature
3. $L = 10mH, I_{AS} = 4.0A, V_{DD} = 50V, R_G = 25\Omega, \text{Starting } T_J = 25^\circ\text{C}$
4. Pulse test: $PW \leq 300\mu s, \text{duty cycle } \leq 2\%$
5. For DESIGN AID ONLY, not subject to production testing.
6. Switching time is essentially independent of operating temperature.
7. $I_{SD} \leq 8A, dI/dt \leq 200A/\mu s, V_{dd} \leq BV_{DSS}, \text{Starting } T_J = 25^\circ\text{C}.$

ORDERING INFORMATION

PART NO.	PACKAGE	PACKING
TSM4N80CZ C0G	TO-220	50pcs / Tube
TSM4N80CI C0G	ITO-220	50pcs / Tube

Note:

1. Compliant to RoHS Directive 2011/65/EU and in accordance to WEEE 2002/96/EC
2. Halogen-free according to IEC 61249-2-21 definition

Not Recommended

CHARACTERISTICS CURVES

($T_C = 25^\circ\text{C}$ unless otherwise noted)

Output Characteristics

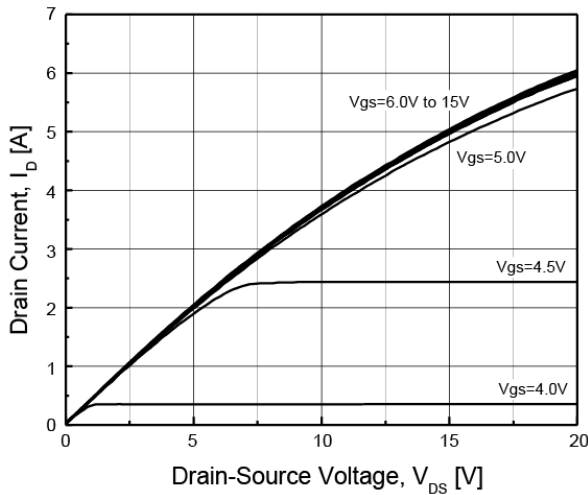

Transfer Characteristics

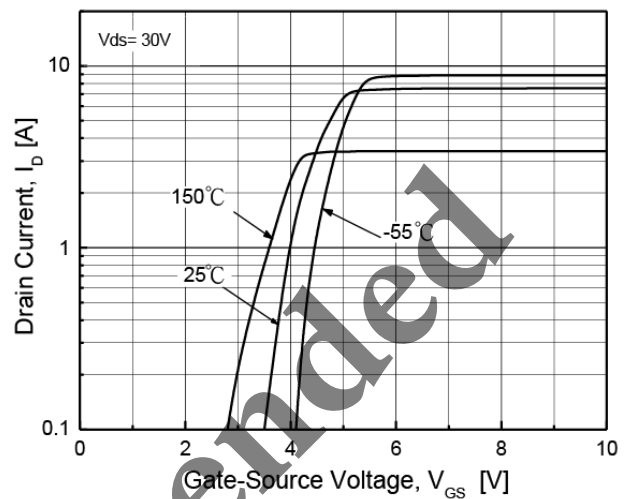

On-Resistance vs. Drain Current

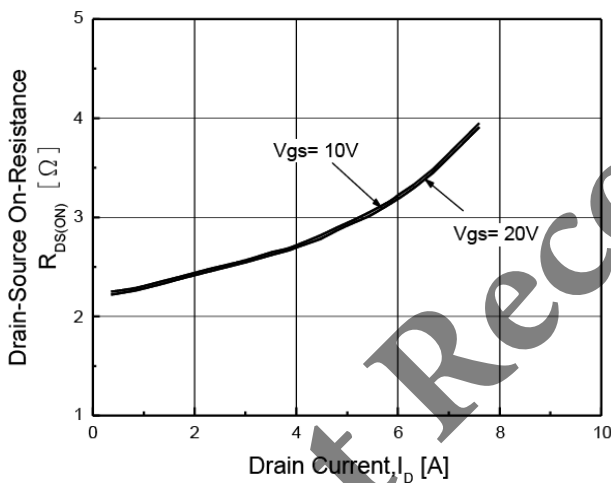

Gate Charge

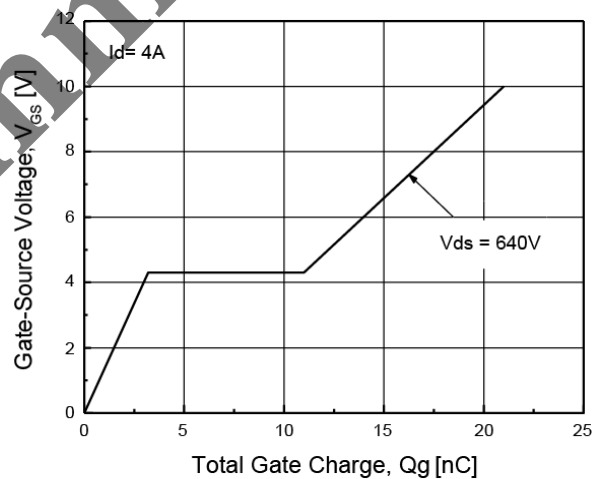

On-Resistance vs. Junction Temperature

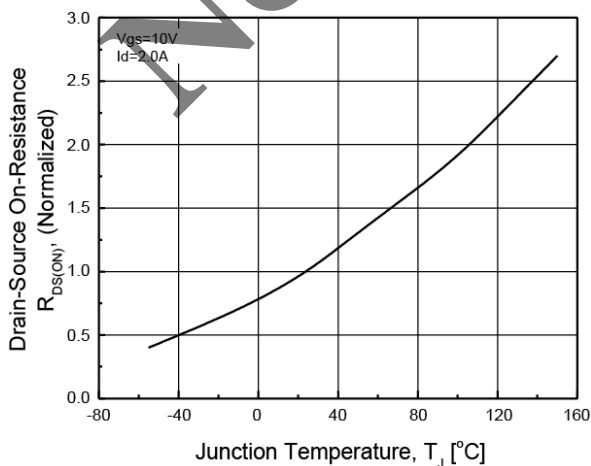

Source-Drain Diode Forward Voltage

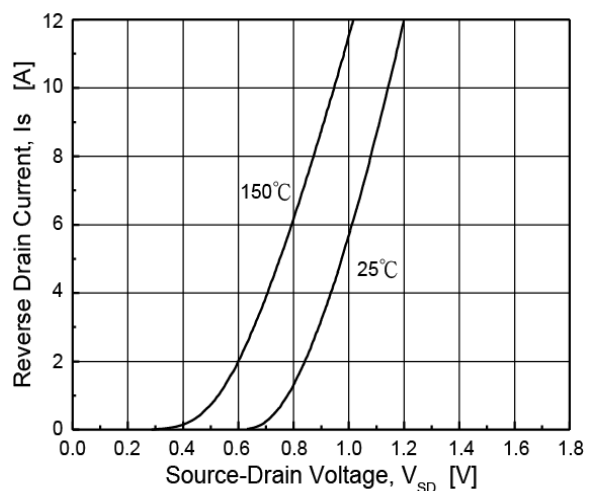

CHARACTERISTICS CURVES

($T_C = 25^\circ\text{C}$ unless otherwise noted)

Drain Current vs. Case Temperature

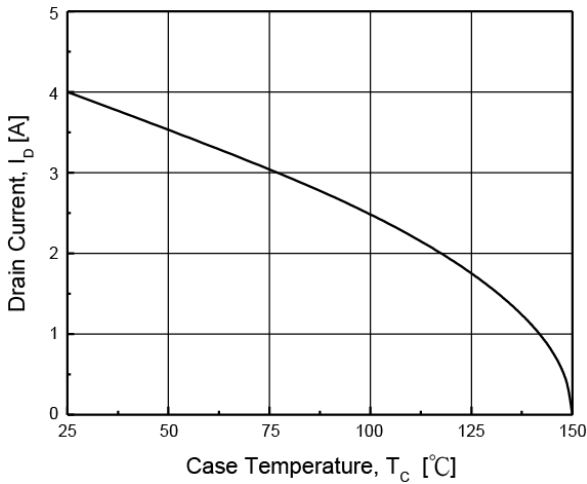

BV_{DSS} vs. Junction Temperature

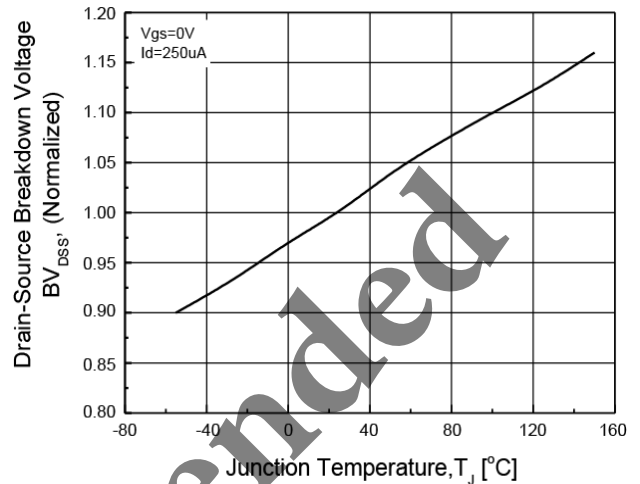

Maximum Safe Operating Area (TO-220)

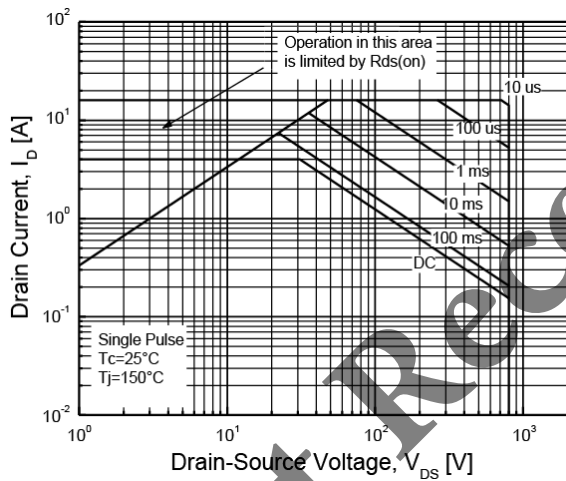

Capacitance vs. Drain-Source Voltage

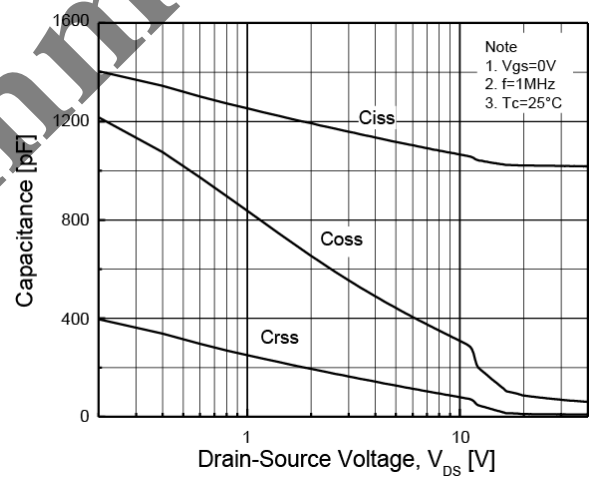

Maximum Safe Operating Area (ITO-220)

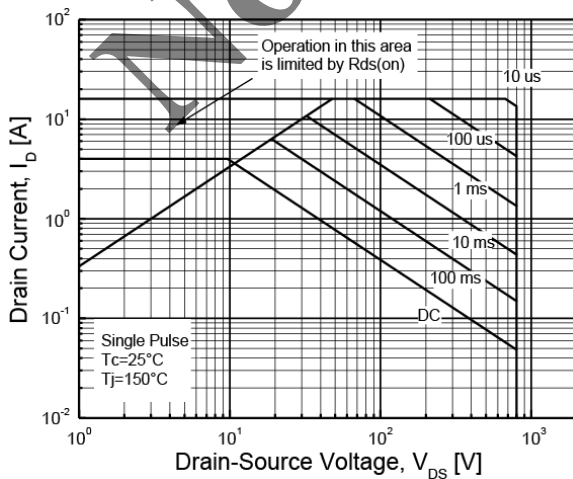

CHARACTERISTICS CURVES

($T_c = 25^\circ\text{C}$ unless otherwise noted)

Normalized Thermal Transient Impedance, Junction-to-Ambient (TO-220)

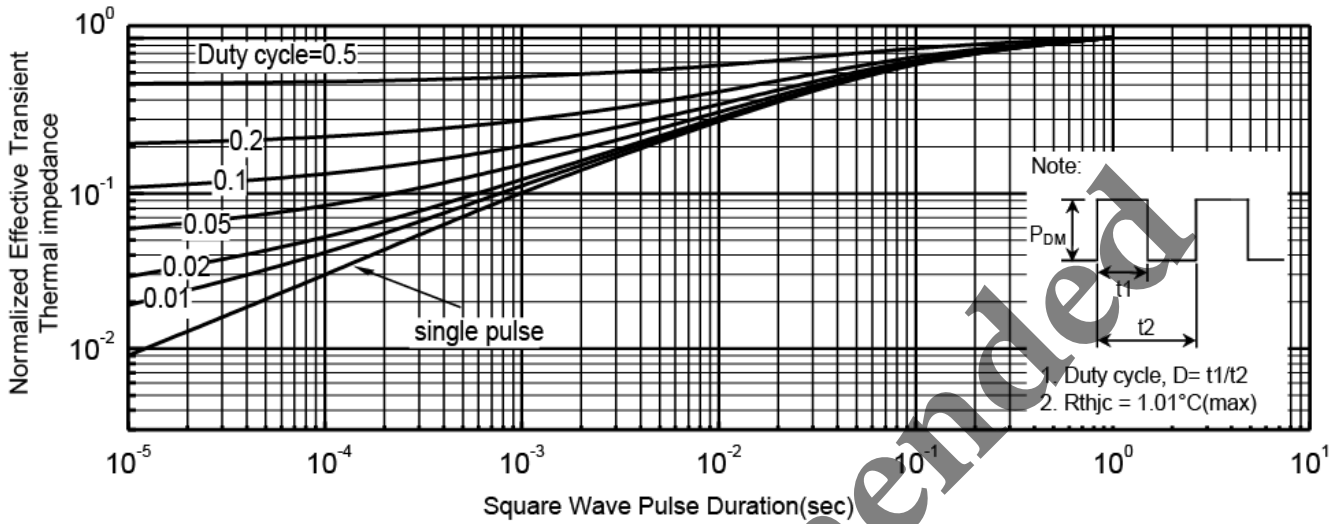

Normalized Thermal Transient Impedance, Junction-to-Ambient (ITO-220)

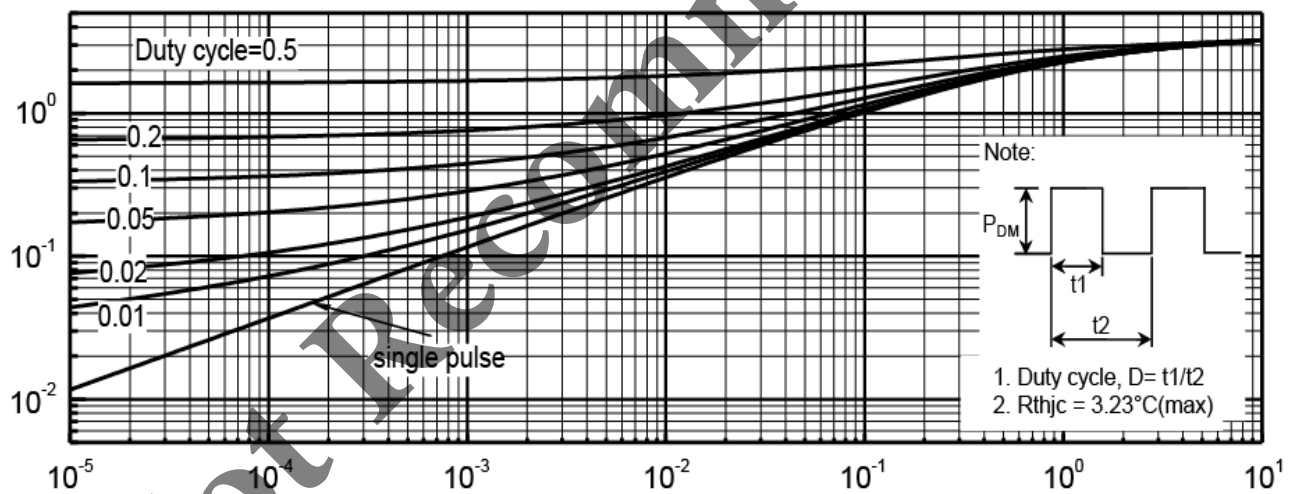

PACKAGE OUTLINE DIMENSIONS (Unit: Millimeters)

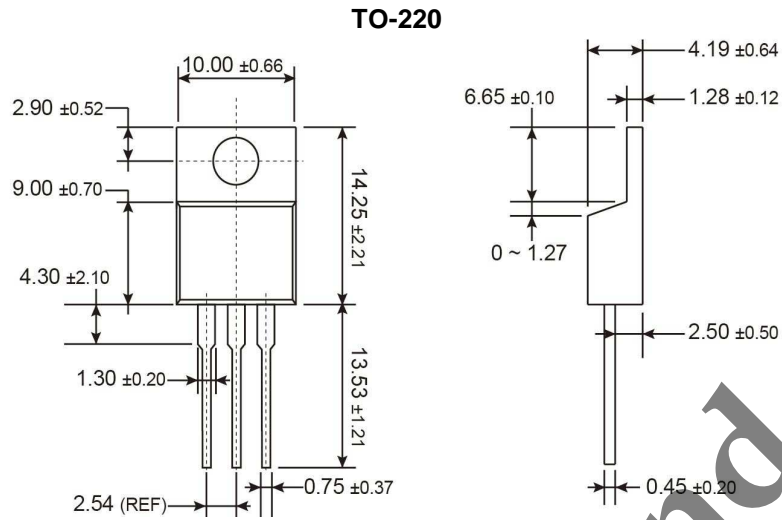

MARKING DIAGRAM

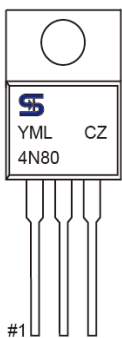

- Y = Year Code
- M = Month Code for Halogen Free Product
 - O =Jan P =Feb Q =Mar R =Apr
 - S =May T =Jun U =Jul V =Aug
 - W =Sep X =Oct Y =Nov Z =Dec
- L = Lot Code (1~9, A~Z)

Not Recommended

PACKAGE OUTLINE DIMENSIONS (Unit: Millimeters)

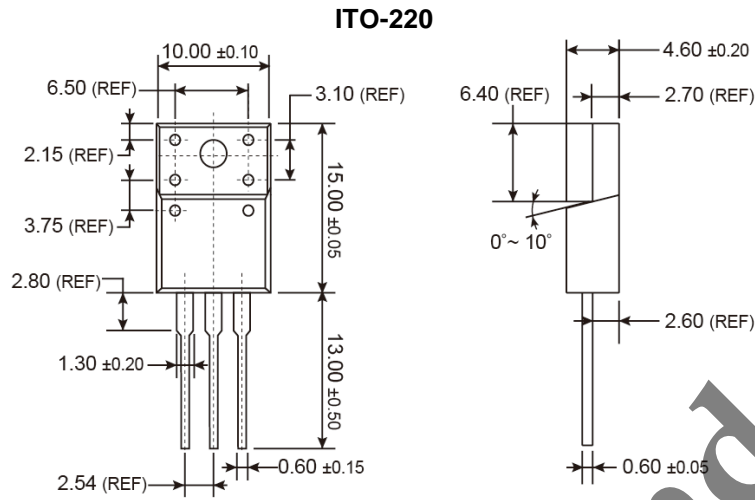

MARKING DIAGRAM

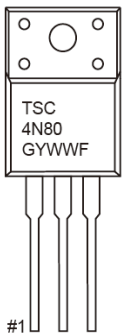

- G** = Halogen Free
- Y** = Year Code
- WW** = Week Code (01~52)
- F** = Factory Code

Not Recommended

Not Recommended

Notice

Specifications of the products displayed herein are subject to change without notice. TSC or anyone on its behalf, assumes no responsibility or liability for any errors or inaccuracies.

Information contained herein is intended to provide a product description only. No license, express or implied, to any intellectual property rights is granted by this document. Except as provided in TSC's terms and conditions of sale for such products, TSC assumes no liability whatsoever, and disclaims any express or implied warranty, relating to sale and/or use of TSC products including liability or warranties relating to fitness for a particular purpose, merchantability, or infringement of any patent, copyright, or other intellectual property right.

The products shown herein are not designed for use in medical, life-saving, or life-sustaining applications. Customers using or selling these products for use in such applications do so at their own risk and agree to fully indemnify TSC for any damages resulting from such improper use or sale.