

CMPA2735030S

30 W, 2.7 - 3.5 GHz, GaN MMIC, Power Amplifier

Description

Cree's CMPA2735030S is a gallium nitride (GaN) High Electron Mobility Transistor (HEMT) based monolithic microwave integrated circuit (MMIC). GaN has superior properties compared to silicon or gallium arsenide, including higher breakdown voltage, higher saturated electron drift velocity and higher thermal conductivity. GaN HEMTs also offer greater power density and wider bandwidths compared to Si and GaAs transistors. This MMIC contains a two-stage reactively matched amplifier design approach enabling high power and power added efficiency to be achieved in a 5mm x 5mm, surface mount (QFN package).

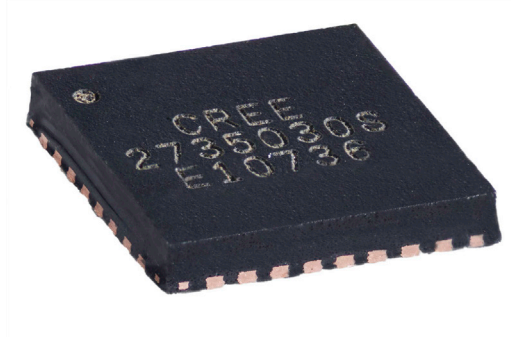

PN: CMPA2735030S
Package: 5x5 mm

Typical Performance Over 2.7 - 3.5 GHz ($T_c = 25^\circ\text{C}$)

Parameter	2.7 GHz	2.9 GHz	3.1 GHz	3.3 GHz	3.5 GHz	Units
Small Signal Gain	33.8	32.9	32.9	33.5	33.4	dB
Output Power ¹	36.5	39.7	40.6	36.0	27.8	W
Power Gain ¹	27.6	28.0	28.1	27.6	26.4	dB
PAE ¹	57	53	51	51	45	%

Note:

¹ $P_{IN} = 18\text{ dBm}$, Pulse Width = 100 μs ; Duty Cycle = 10%

Features

- 32 dB Small Signal Gain
- Operation up to 50 V
- High Breakdown Voltage
- High Temperature Operation
- 5 mm x 5 mm Total Product Size

Applications

- Civil and Military Pulsed Radar Amplifiers

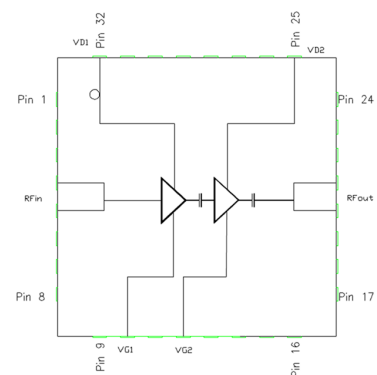

Figure 1.

RoHS
COMPLIANT



Absolute Maximum Ratings (not simultaneous) at 25 °C

Parameter	Symbol	Rating	Units	Conditions
Drain-source Voltage	V_{DSS}	150	VDC	25°C
Gate-source Voltage	V_{GS}	-10, +2	VDC	25°C
Storage Temperature	T_{STG}	-65, +150	°C	
Maximum Forward Gate Current	I_G	15.5	mA	25°C
Soldering Temperature	T_S	260	°C	

Electrical Characteristics (Frequency = 2.7 GHz to 3.5 GHz unless otherwise stated; $T_c = 25 °C$)

Characteristics	Symbol	Min.	Typ.	Max.	Units	Conditions
DC Characteristics						
Gate Threshold Voltage	$V_{GS(TH)}$	-3.8	-3.0	-2.3	V	$V_{DS} = 10 V, I_D = 7.6 mA$
Gate Quiescent Voltage	$V_{GS(Q)}$	-	-2.7	-	V _{DC}	$V_{DD} = 50 V, I_{DQ} = 135 mA$
Saturated Drain Current ¹	I_{DS}	-	4.6	-	A	$V_{DS} = 6.0 V, V_{GS} = 2.0 V$
Drain-Source Breakdown Voltage	V_{BD}	-	150	-	V	$V_{GS} = -8 V, I_D = 7.6 mA$
RF Characteristics^{2,3}						
Small Signal Gain	$S21_1$	-	33.8	-	dB	$V_{DD} = 50 V, I_{DQ} = 135 mA, Freq = 2.7 GHz$
Small Signal Gain	$S21_2$	-	32.9	-	dB	$V_{DD} = 50 V, I_{DQ} = 135 mA, Freq = 3.1 GHz$
Small Signal Gain	$S21_3$	-	33.4	-	dB	$V_{DD} = 50 V, I_{DQ} = 135 mA, Freq = 3.5 GHz$
Power Output	P_{OUT1}	-	36.5	-	W	$V_{DD} = 50 V, I_{DQ} = 135 mA, P_{IN} = 21 dBm, Freq = 2.7 GHz$
Power Output	P_{OUT2}	-	40.6	-	W	$V_{DD} = 50 V, I_{DQ} = 135 mA, P_{IN} = 21 dBm, Freq = 3.1 GHz$
Power Output	P_{OUT3}	-	27.8	-	W	$V_{DD} = 50 V, I_{DQ} = 135 mA, P_{IN} = 21 dBm, Freq = 3.5 GHz$
Power Added Efficiency	PAE_1	-	57	-	%	$V_{DD} = 50 V, I_{DQ} = 135 mA, Freq = 2.7 GHz$
Power Added Efficiency	PAE_2	-	51	-	%	$V_{DD} = 50 V, I_{DQ} = 135 mA, Freq = 3.1 GHz$
Power Added Efficiency	PAE_3	-	45	-	%	$V_{DD} = 50 V, I_{DQ} = 135 mA, Freq = 3.5 GHz$
Input Return Loss	$S11_1$	-	-18.2	-	dB	$V_{DD} = 50 V, I_{DQ} = 135 mA, Freq = 2.7 GHz$
Input Return Loss	$S11_2$	-	-13.4	-	dB	$V_{DD} = 50 V, I_{DQ} = 135 mA, Freq = 3.1 GHz$
Input Return Loss	$S11_3$	-	-27.0	-	dB	$V_{DD} = 50 V, I_{DQ} = 135 mA, Freq = 3.5 GHz$
Output Return Loss	$S22_1$	-	-14.9	-	dB	$V_{DD} = 50 V, I_{DQ} = 135 mA, Freq = 2.7 GHz$
Output Return Loss	$S22_2$	-	-9.5	-	dB	$V_{DD} = 50 V, I_{DQ} = 135 mA, Freq = 3.1 GHz$
Output Return Loss	$S22_3$	-	-16.5	-	dB	$V_{DD} = 50 V, I_{DQ} = 135 mA, Freq = 3.5 GHz$
Output Mismatch Stress	VSWR	-	5:1	-	Ψ	No damage at all phase angles, $V_{DD} = 50 V, I_{DQ} = 135 mA, P_{IN} = 18 dBm$

Notes:

¹ Scaled from PCM data

² Measured in CMPA2735030S high volume test fixture at 2.7, 3.1 and 3.5 GHz and may not show the full capability of the device due to source inductance and thermal performance.

³ Pulse Width = 25 μs; Duty Cycle = 1%

Thermal Characteristics

Parameter	Symbol	Rating	Units	Conditions
Operating Junction Temperature	T_J	225	°C	
Thermal Resistance, Junction to Case (packaged) ¹	R_{JC}	2.62	°C/W	Pulse Width = 500 μs, Duty Cycle = 10%

Notes:

¹ Measured for the CMPA2735030S at $P_{DISS} = 32 W$



Typical Performance of the CMPA2735030S

Test conditions unless otherwise noted: $V_D = 50\text{ V}$, $I_{DQ} = 130\text{ mA}$, $PW = 100\text{ }\mu\text{s}$, $DC = 10\%$, $P_{in} = 18\text{ dBm}$, $T_{BASE} = +25\text{ }^\circ\text{C}$

Figure 1. Output Power vs Frequency as a Function of Temperature

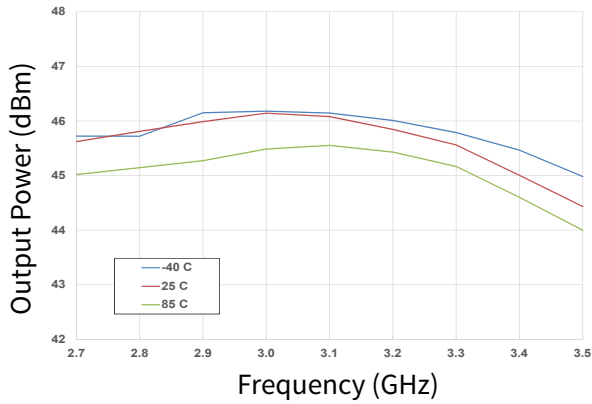

Figure 2. Output Power vs Frequency as a Function of Input Power

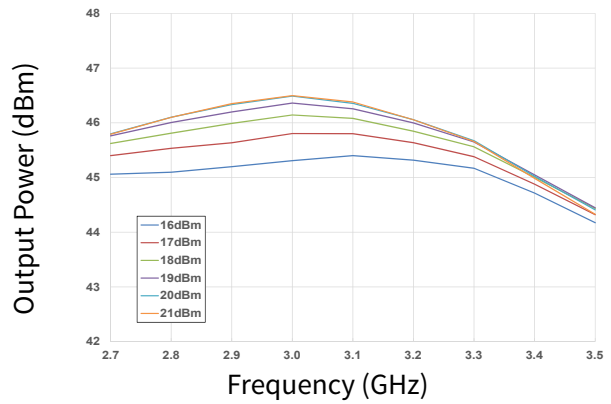

Figure 3. Power Added Eff. vs Frequency as a Function of Temperature

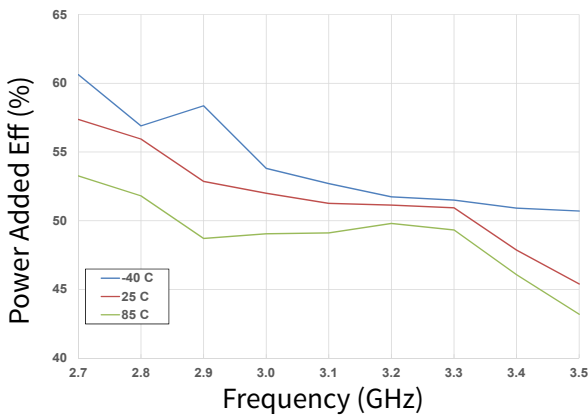

Figure 4. Power Added Eff. vs Frequency as a Function of Input Power

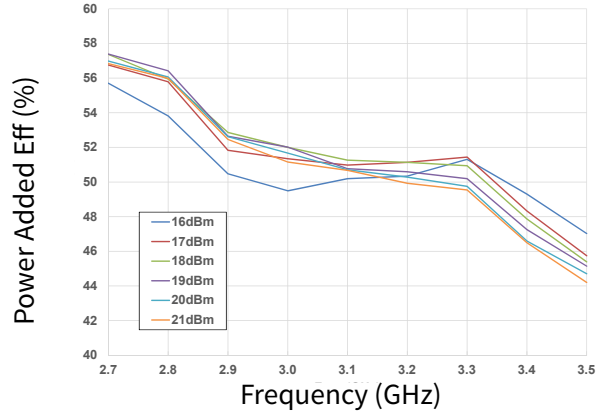

Figure 5. Drain Current vs Frequency as a Function of Temperature

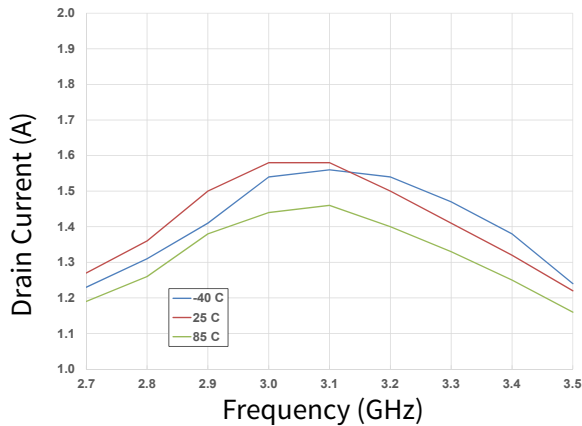
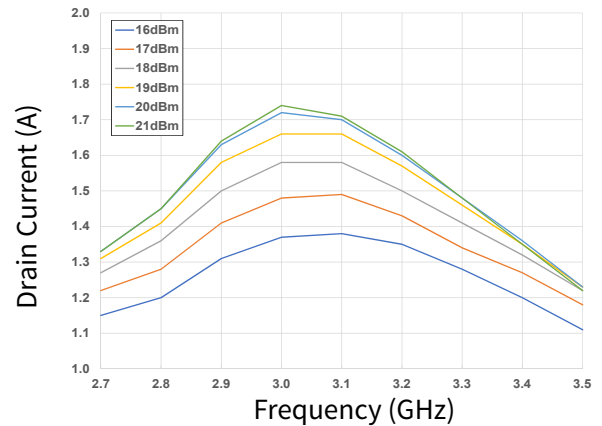

Figure 6. Drain Current vs Frequency as a Function of Input Power





Typical Performance of the CMPA2735030S

Test conditions unless otherwise noted: $V_D = 50\text{ V}$, $I_{DQ} = 130\text{ mA}$, $PW = 100\ \mu\text{s}$, $DC = 10\%$, $P_{in} = 18\text{ dBm}$, $T_{BASE} = +25\text{ }^\circ\text{C}$

Figure 7. Output Power vs Frequency as a Function of V_D

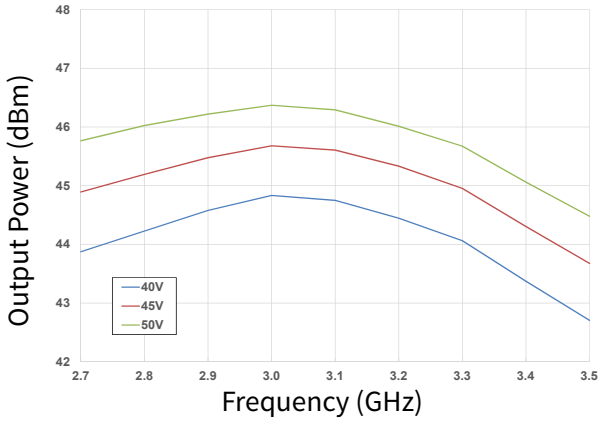

Figure 8. Output Power vs Frequency as a Function of I_{DQ}

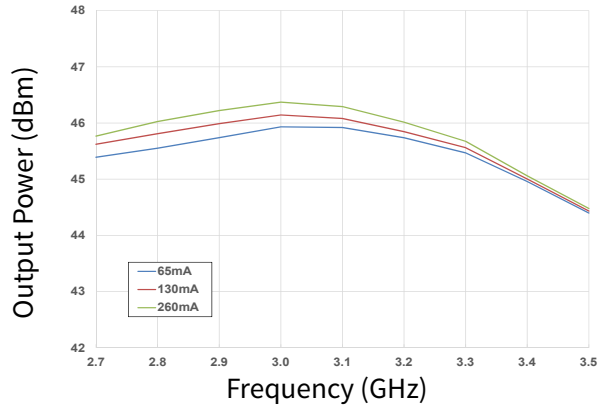

Figure 9. Power Added Eff. vs Frequency as a Function of V_D

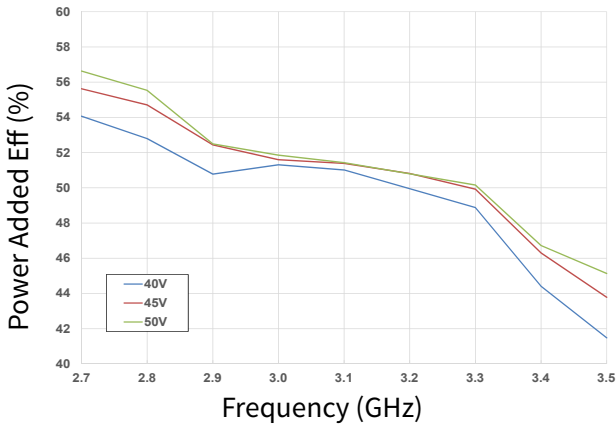

Figure 10. Power Added Eff. vs Frequency as a Function of I_{DQ}

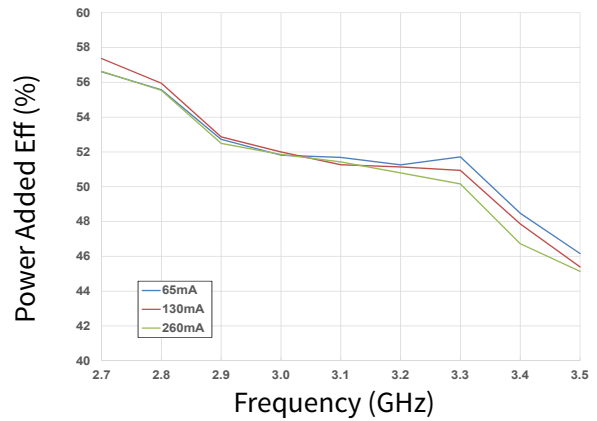

Figure 11. Drain Current vs Frequency as a Function of V_D

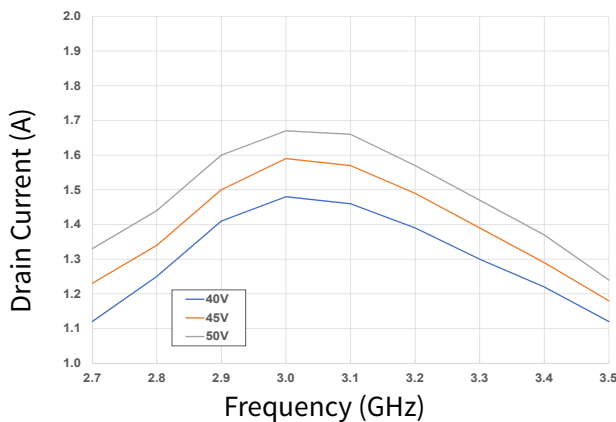
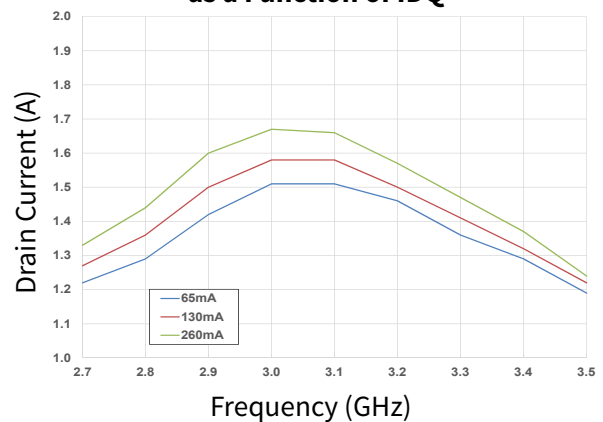

Figure 12. Drain Current vs Frequency as a Function of I_{DQ}





Typical Performance of the CMPA2735030S

Test conditions unless otherwise noted: $V_D = 50\text{ V}$, $I_{DQ} = 130\text{ mA}$, $PW = 100\text{ }\mu\text{s}$, $DC = 10\%$, $P_{in} = 18\text{ dBm}$, $T_{BASE} = +25\text{ }^\circ\text{C}$

Figure 13. Output Power vs Input Power as a Function of Frequency

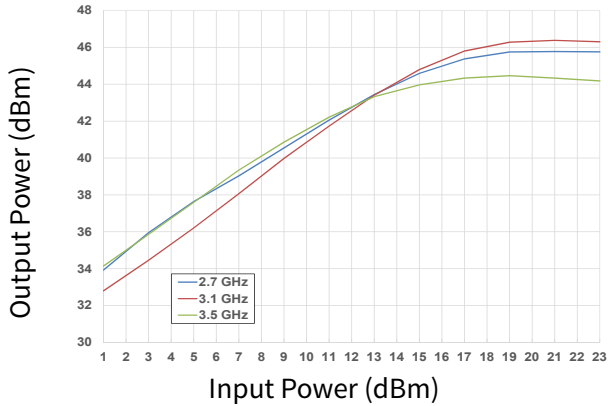

Figure 14. Power Added Eff. vs Input Power as a Function of Frequency

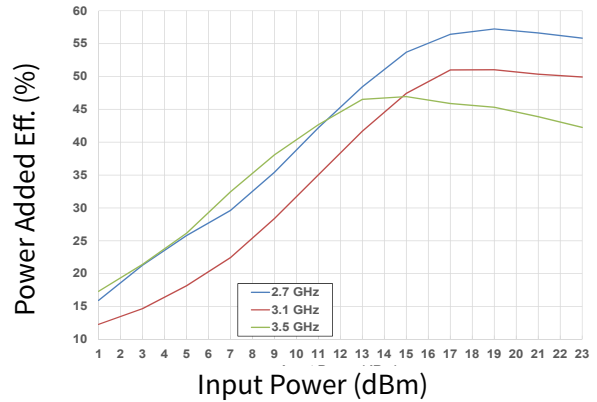

Figure 15. Large Signal Gain vs Input Power as a Function of Frequency

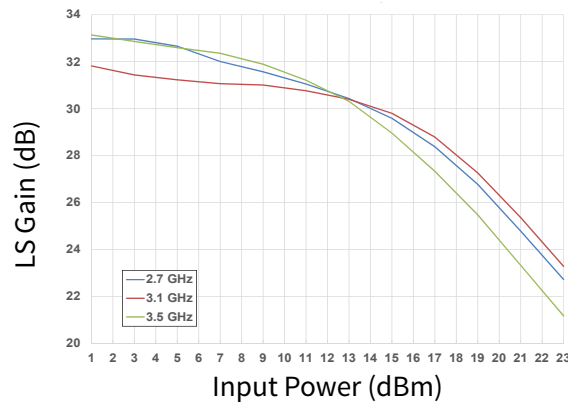

Figure 16. Drain Current vs Input Power as a Function of Frequency

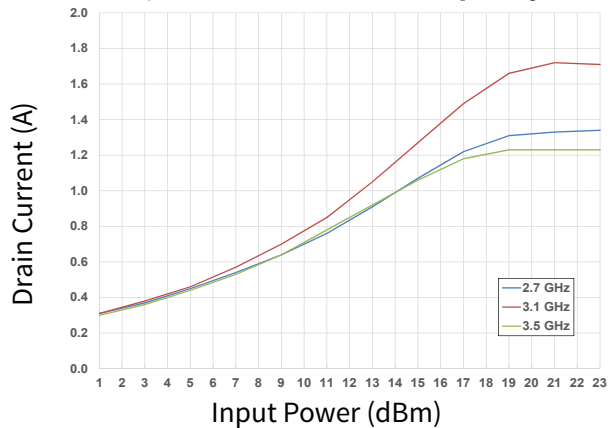
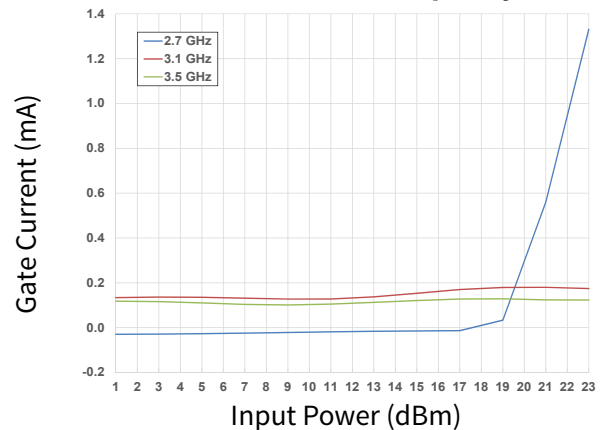

Figure 17. Gate Current vs Input Power as a Function of Frequency





Typical Performance of the CMPA2735030S

Test conditions unless otherwise noted: $V_D = 50\text{ V}$, $I_{DQ} = 130\text{ mA}$, $PW = 100\text{ }\mu\text{s}$, $DC = 10\%$, $P_{in} = 18\text{ dBm}$, $T_{BASE} = +25\text{ }^\circ\text{C}$

Figure 18. Output Power vs Input Power as a Function of Temperature

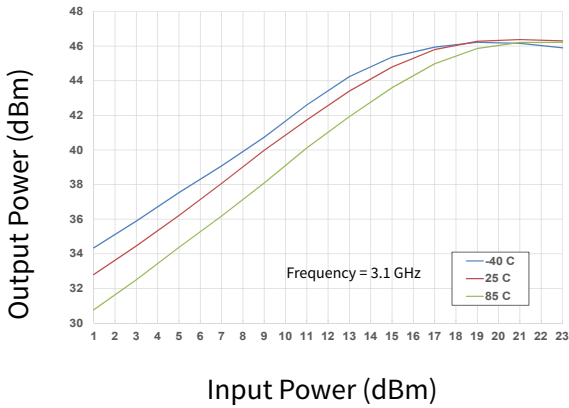

Figure 19. Power Added Eff. vs Input Power as a Function of Temperature

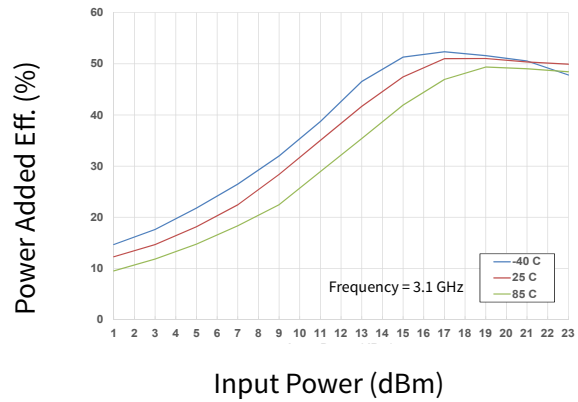

Figure 20. Large Signal Gain vs Input Power as a Function of Temperature

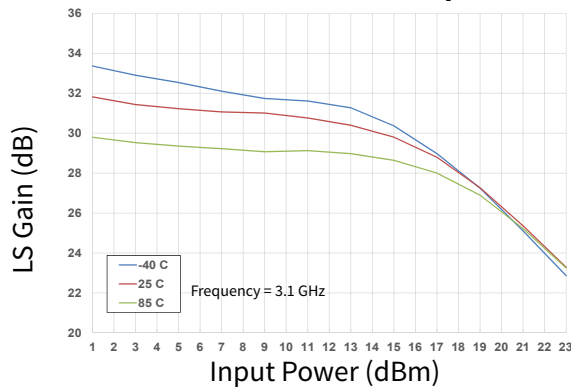

Figure 21. Drain Current vs Input Power as a Function of Temperature

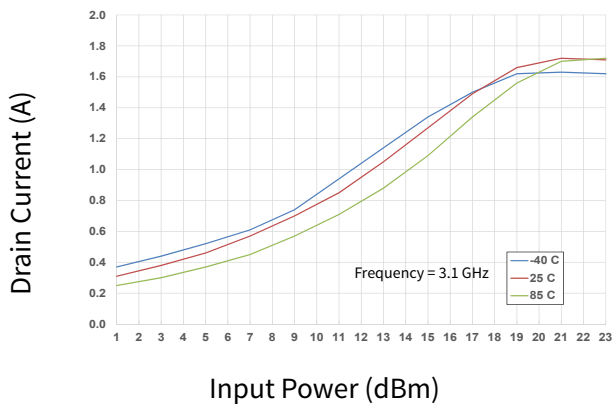
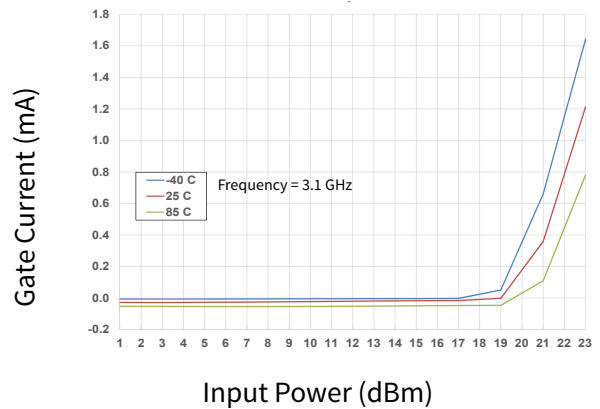

Figure 22. Gate Current vs Input Power as a Function of Temperature





Typical Performance of the CMPA2735030S

Test conditions unless otherwise noted: $V_D = 50\text{ V}$, $I_{DQ} = 130\text{ mA}$, $PW = 100\text{ }\mu\text{s}$, $DC = 10\%$, $P_{in} = 18\text{ dBm}$, $T_{BASE} = +25\text{ }^\circ\text{C}$

Figure 23. Output Power vs Input Power as a Function of IDQ

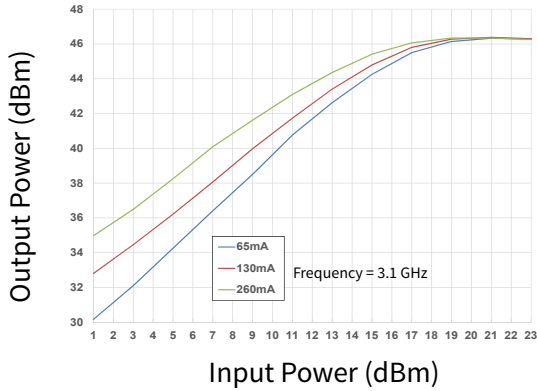

Figure 24. Power Added Eff. vs Input Power as a Function of IDQ

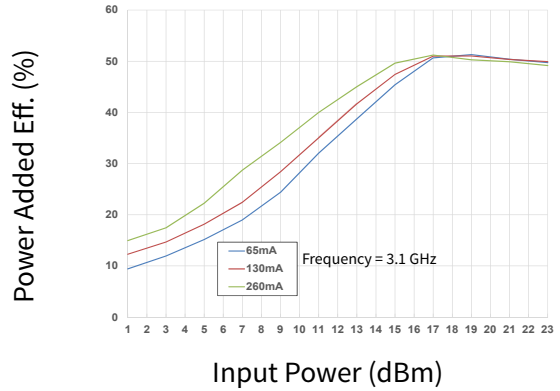

Figure 25. Large Signal Gain vs Input Power as a Function of IDQ

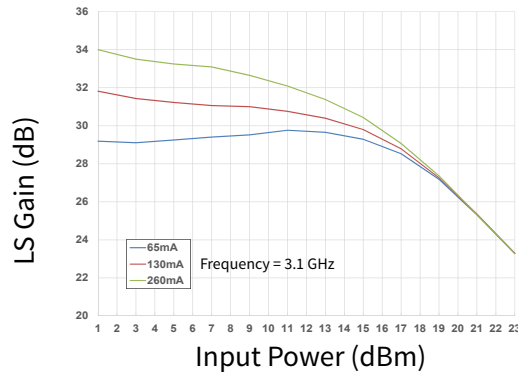

Figure 26. Drain Current vs Input Power as a Function of IDQ

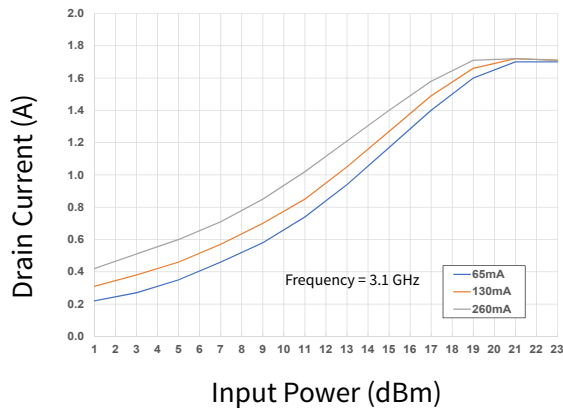
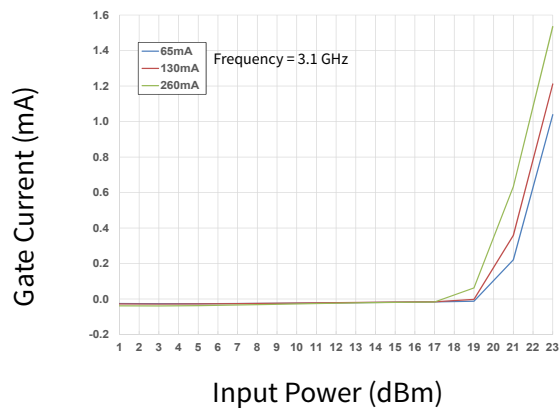

Figure 27. Gate Current vs Input Power as a Function of IDQ





Typical Performance of the CMPA2735030S

Test conditions unless otherwise noted: $V_D = 50\text{ V}$, $I_{DQ} = 130\text{ mA}$, $PW = 100\text{ }\mu\text{s}$, $DC = 10\%$, $P_{in} = 18\text{ dBm}$, $T_{BASE} = +25\text{ }^\circ\text{C}$

Figure 28. 2nd Harmonic vs Frequency as a Function of Temperature

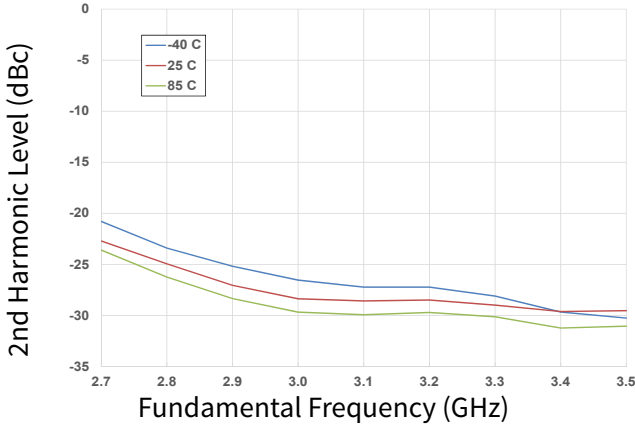

Figure 29. 3rd Harmonic vs Frequency as a Function of Temperature

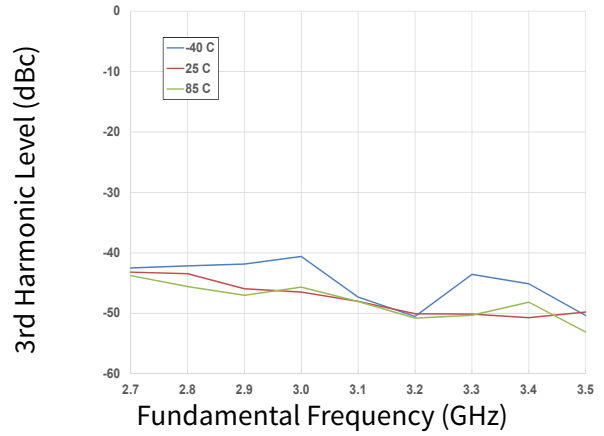

Figure 30. 2nd Harmonic vs Input Power as a Function of Frequency

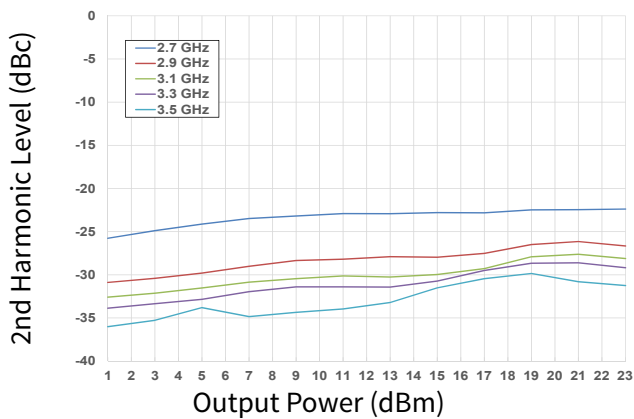

Figure 31. 3rd Harmonic vs Input Power as a Function of Frequency

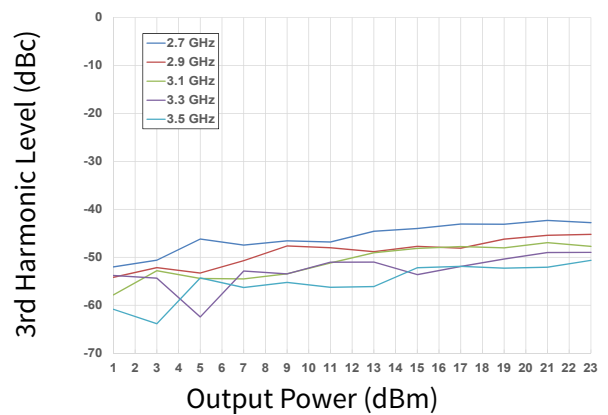

Figure 32. 2nd Harmonic vs Output Power as a Function of IDQ

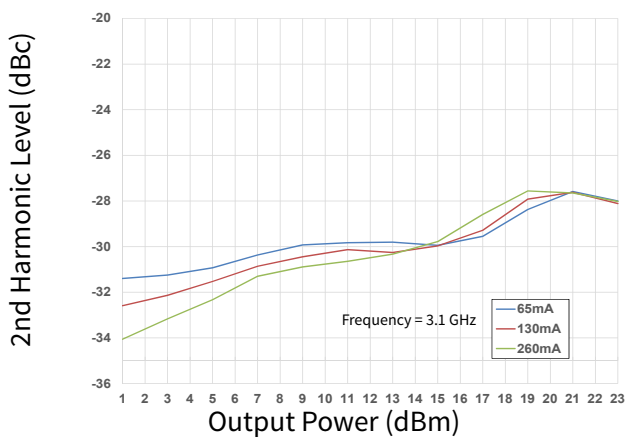
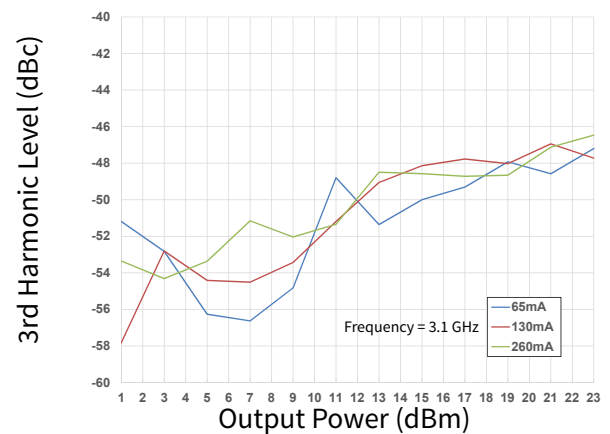

Figure 33. 3rd Harmonic vs Output Power as a Function of IDQ





Typical Performance of the CMPA2735030S

Test conditions unless otherwise noted: $V_D = 50\text{ V}$, $I_{DQ} = 130\text{ mA}$, $P_{in} = -20\text{ dBm}$, $T_{BASE} = +25\text{ }^\circ\text{C}$

Figure 34. 2nd Harmonic vs Output Power as a Function of Frequency

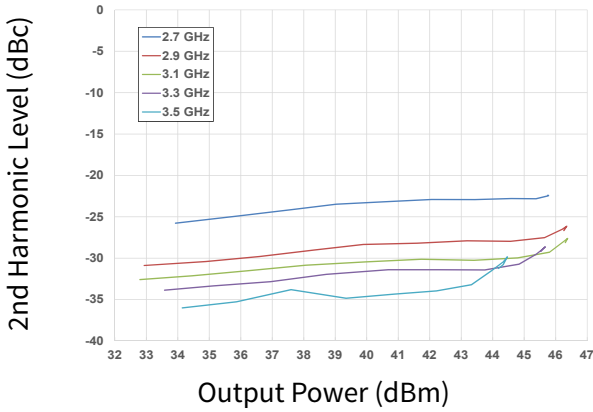

Figure 35. 3rd Harmonic vs Output Power as a Function of Frequency

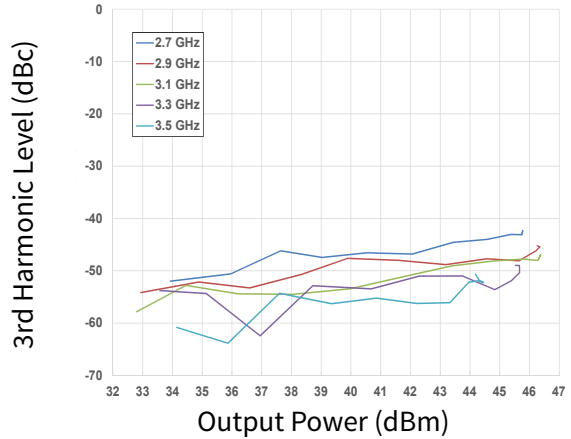

Figure 36. 2nd Harmonic vs Output Power as a Function of IDQ

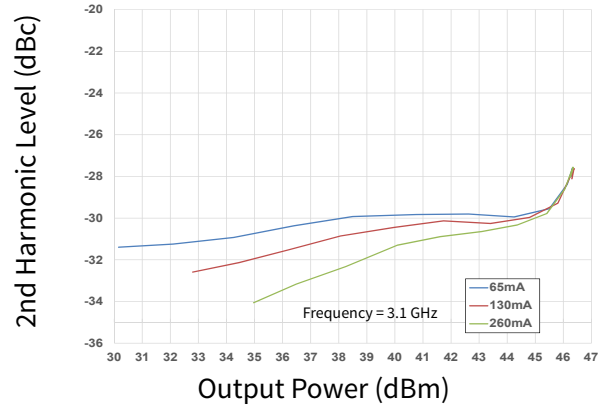
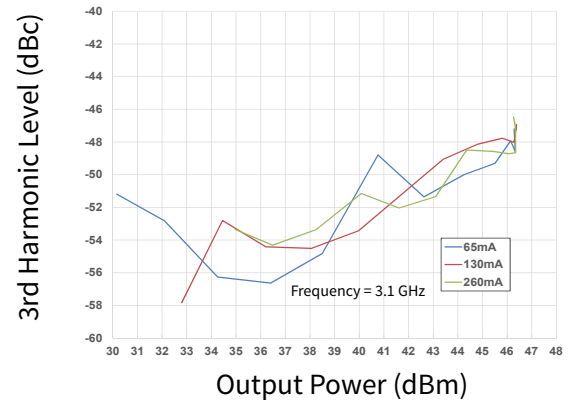

Figure 37. 3rd Harmonic vs Output Power as a Function of IDQ



Typical Performance of the CMPA2735030S

Test conditions unless otherwise noted: $V_D = 50\text{ V}$, $I_{DQ} = 130\text{ mA}$, $P_{in} = -20\text{ dBm}$, $T_{BASE} = +25\text{ }^\circ\text{C}$

Figure 38. Gain vs Frequency as a Function of Temperature

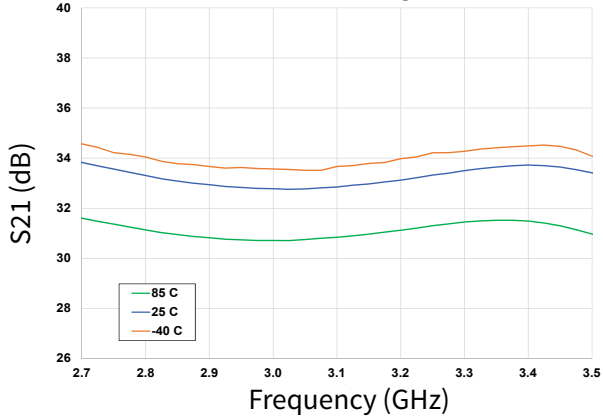

Figure 39. Gain vs Frequency as a Function of Temperature

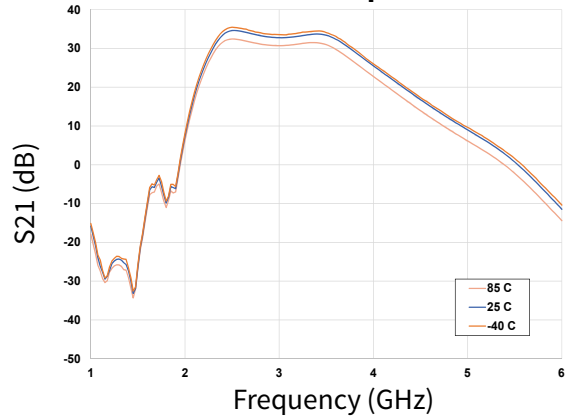

Figure 40. Input RL vs Frequency as a Function of Temperature

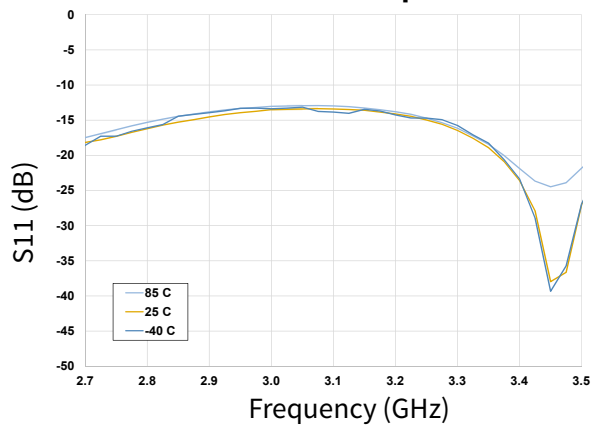

Figure 41. Input RL vs Frequency as a Function of Temperature

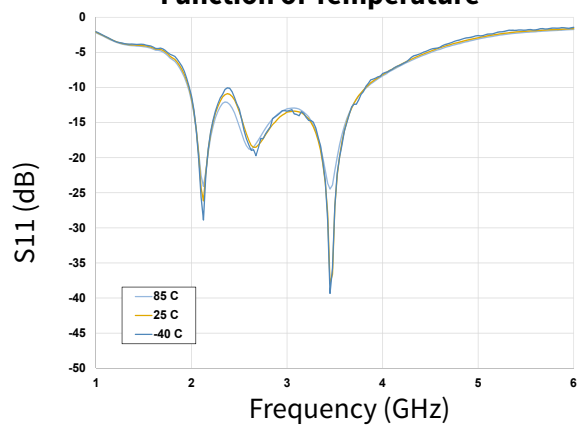

Figure 42. Output RL vs Frequency as a Function of Temperature

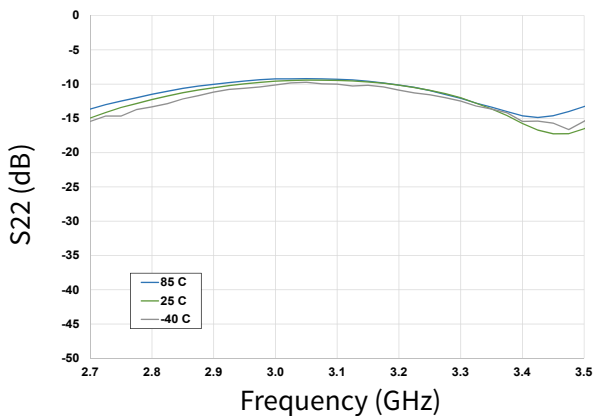
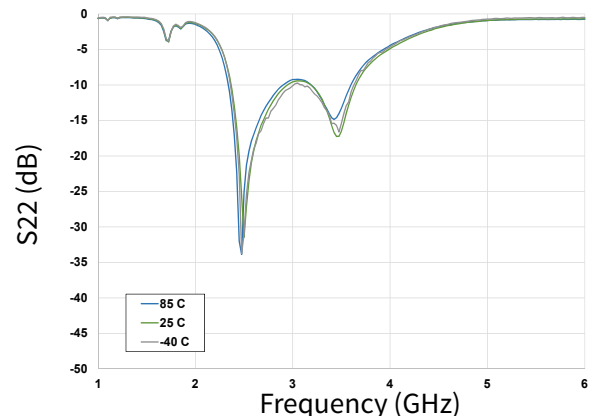

Figure 43. Output RL vs Frequency as a Function of Temperature



Typical Performance of the CMPA2735030S

Test conditions unless otherwise noted: $V_D = 50\text{ V}$, $I_{DQ} = 130\text{ mA}$, $P_{in} = -20\text{ dBm}$, $T_{BASE} = +25\text{ }^\circ\text{C}$

Figure 44. Gain vs Frequency as a Function of Voltage

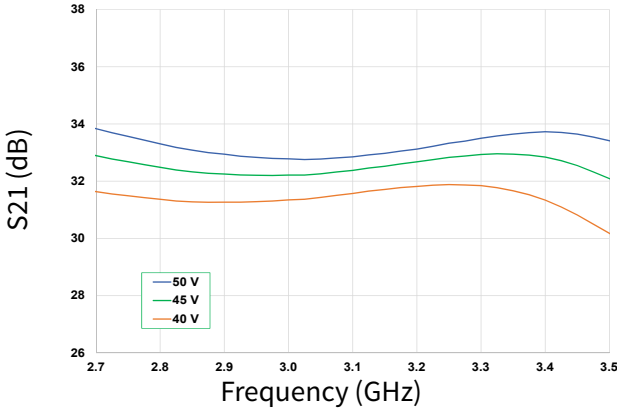

Figure 45. Gain vs Frequency as a Function of IDQ

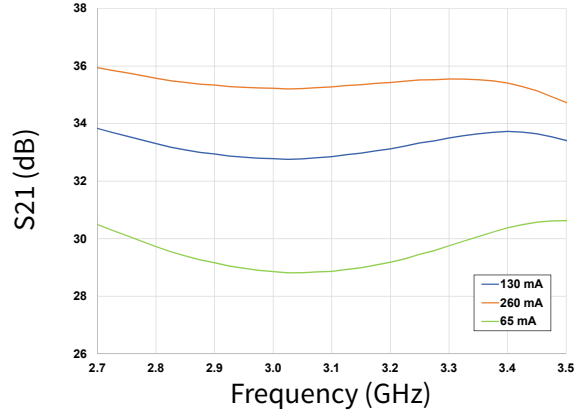

Figure 46. Input RL vs Frequency as a Function Voltage

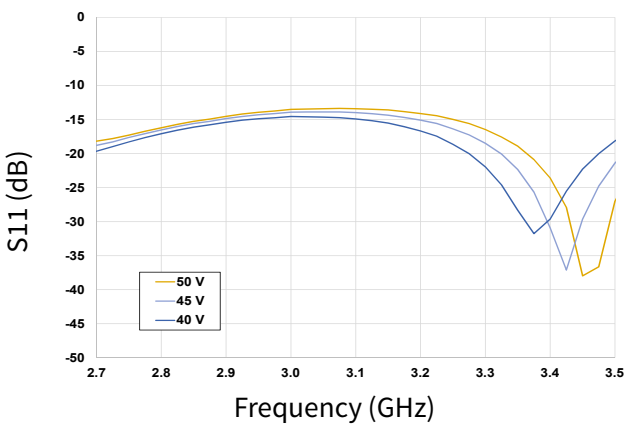

Figure 47. Input RL vs Frequency as a Function of IDQ

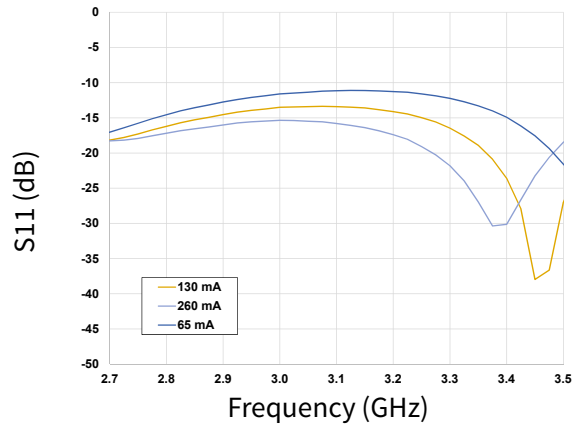

Figure 48. Output RL vs Frequency as a Function of Voltage

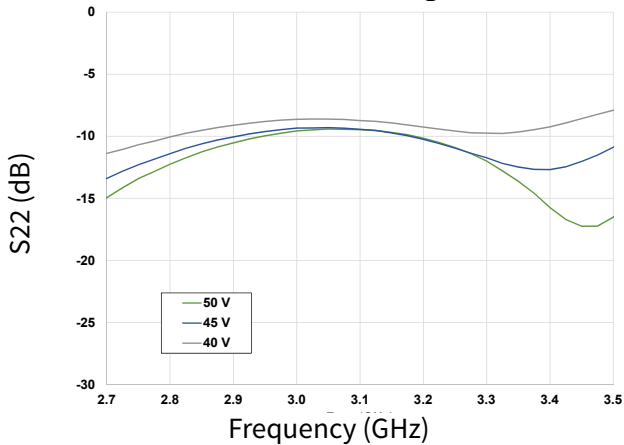
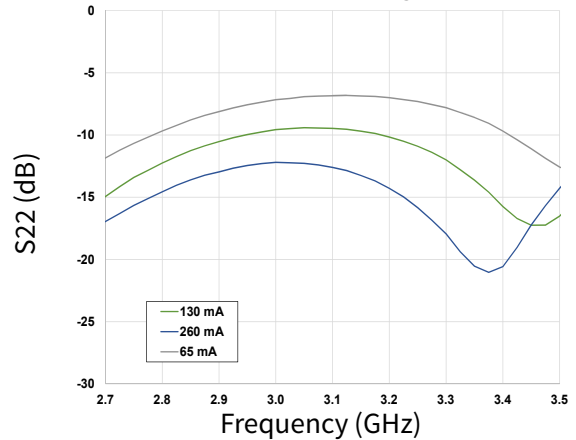

Figure 49. Output RL vs Frequency as a Function of IDQ



CMPA2735030S-AMP1 Evaluation Board Bill of Materials

Designator	Description	Qty
C1, C4, C10, C11	CAP, 470pF, 100V, 0603	4
C2, C3	CAP, 100pF, 100V, 0603	2
C5, C6, C8, C9	CAP, 10pF, 100V, 0402	4
C7	CAP, 33uF, 50V, ELECT, MVY, SMD	1
C12,C13	CAP, 10uF, 16V, TANTALUM, SMD	2
R1, R2	RES, 100Ohm, 1/16W, 0603	2
J1, J2	CONNECTOR, N-TYPE, FEMALE, W/0.500 SMA FLNG	2
J3, J4	CONNECTOR, HEADER, RT>PLZ .1CEN LK 5POS	2
-	PCB, RO4350B, E _r = 3.48, h = 10 mil	1
Q1	CMPA2735030S	1

CMPA2735030S-AMP1 Evaluation Board

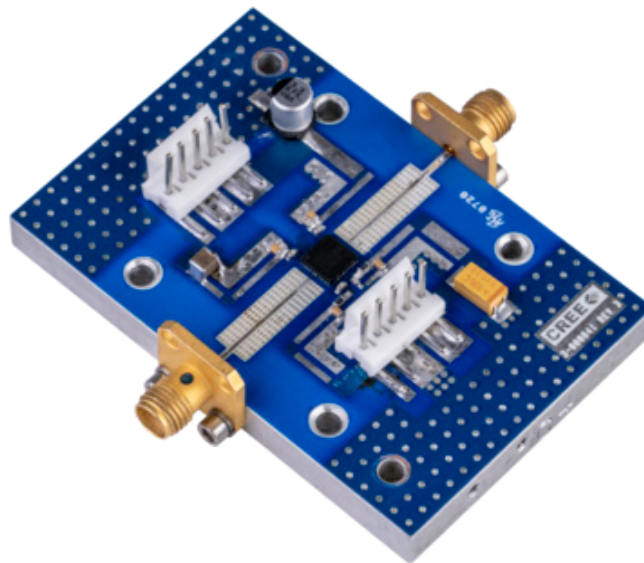

CMPA2735030S-AMP1 Application Circuit

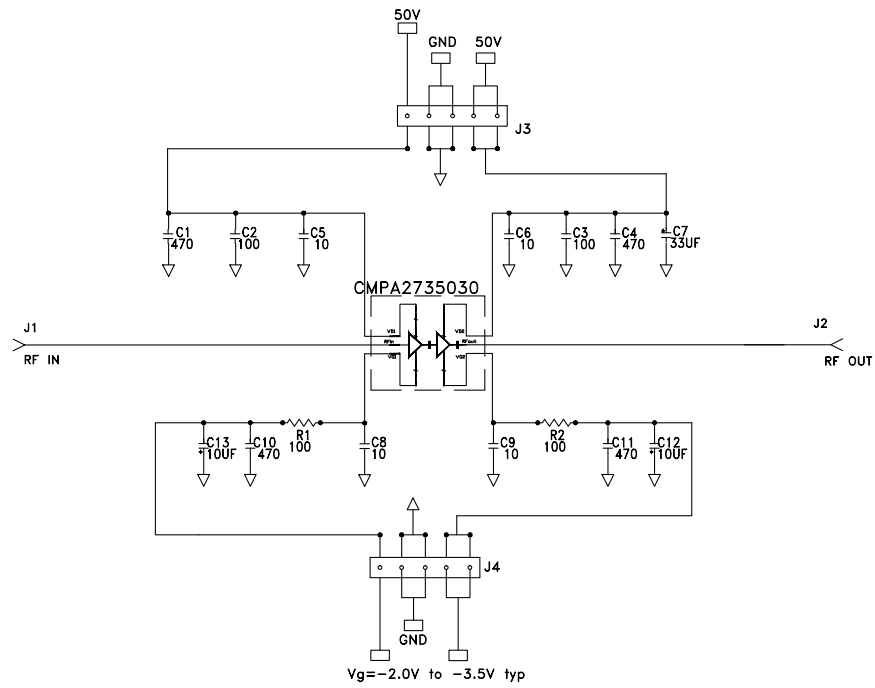

CMPA2735030S-AMP1 Evaluation Board Layout

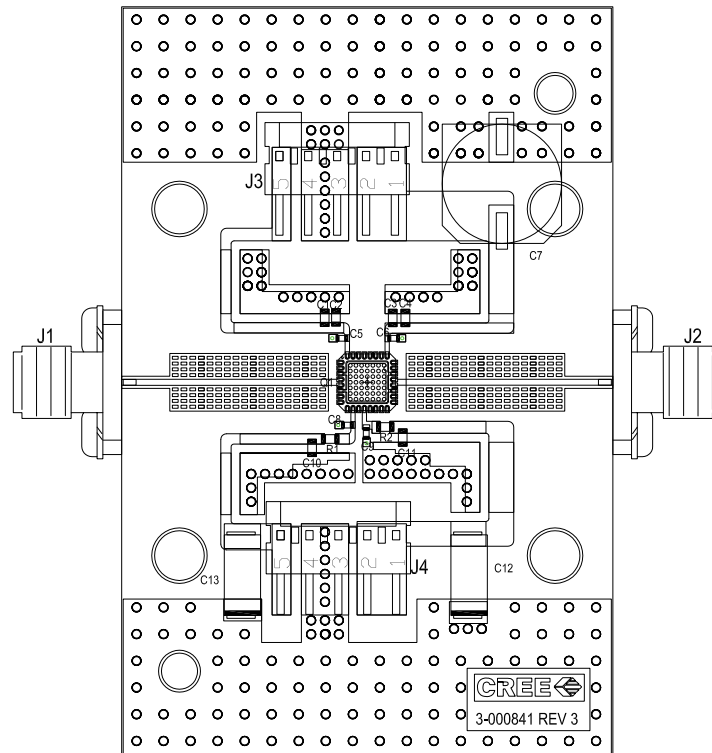

Product Dimensions CPMA2735030S (Package)

SYMBOL	MIN. NOM. MAX.			NOTE
	MIN.	NOM.	MAX.	
A	0.80	0.86	0.91	
A1	0.00	0.03	0.06	
A3	0.20 REF			
Ø	0		12	2
K	0.17 MIN.			
D	5.0 BSC			
E	5.0 BSC			

SYMBOL	0.50mm LEAD PITCH			NOTE
	MIN.	NOM.	MAX.	
Ø	0.50 BSC.			
N	32			3
ND	8			4
NE	8			5
L	0.35	0.41	0.46	
b	0.21	0.25	0.29	6
D2	3.76	3.82	3.88	
E2	3.76	3.82	3.88	

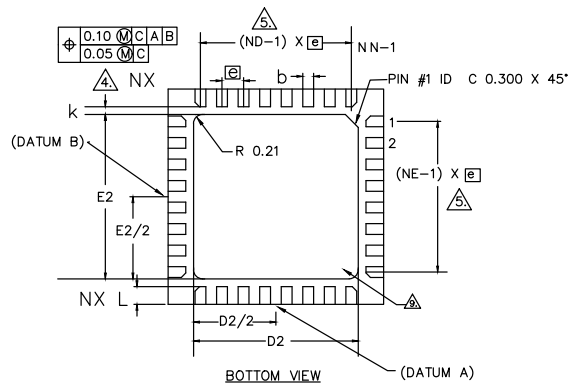
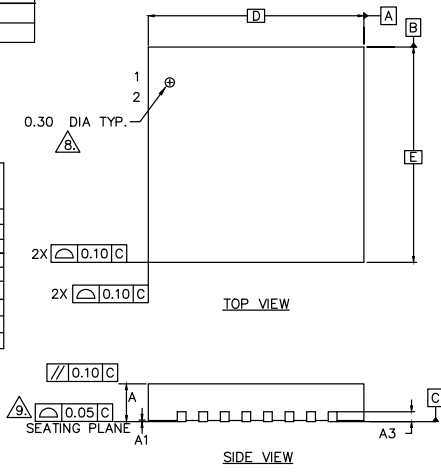

PIN	DESC.	PIN	DESC.	PIN	DESC.
1	NC	15	NC	29	NC
2	NC	16	NC	30	NC
3	NC	17	NC	31	NC
4	RFIN	18	NC	32	VD1
5	RFIN	19	NC		
6	NC	20	RFOUT		
7	NC	21	RFOUT		
8	NC	22	NC		
9	NC	23	NC		
10	VG1	24	NC		
11	VG2	25	VD2		
12	NC	26	NC		
13	NC	27	NC		
14	NC	28	NC		

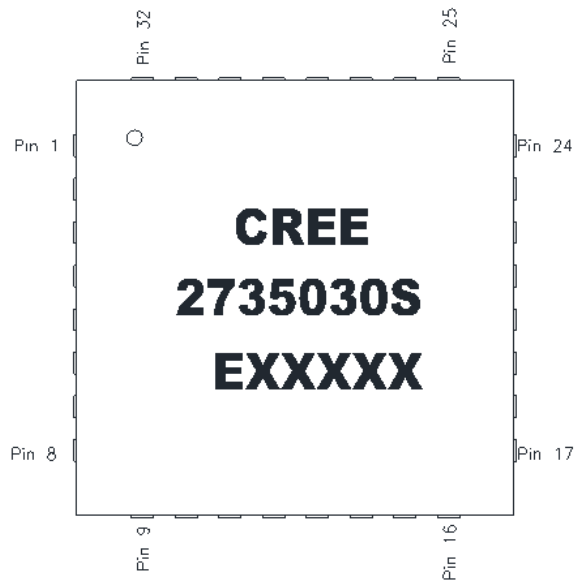

Part Number System

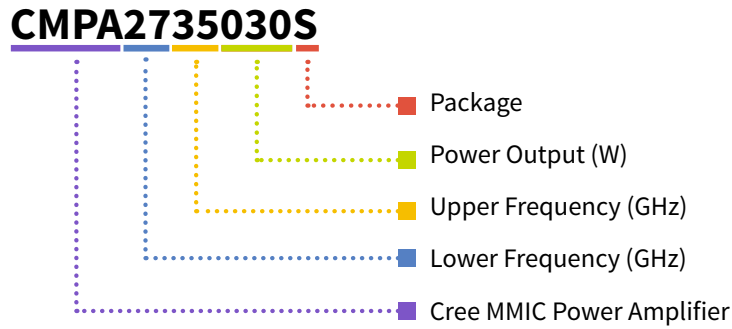

Table 1.

Parameter	Value	Units
Lower Frequency	2.7	GHz
Upper Frequency	3.5	GHz
Power Output	30	W
Package	Surface Mount	-

Note: Alpha characters used in frequency code indicate a value greater than 9.9 GHz. See Table 2 for value.

Table 2.

Character Code	Code Value
A	0
B	1
C	2
D	3
E	4
F	5
G	6
H	7
J	8
K	9
Examples:	1A = 10.0 GHz 2H = 27.0 GHz



Product Ordering Information

Order Number	Description	Unit of Measure	Image
CMPA2735030S	GaN HEMT	Each	
CMPA2735030S-AMP1	Test board with GaN MMIC installed	Each	



For more information, please contact:

4600 Silicon Drive
Durham, North Carolina, USA 27703
www.wolfspeed.com/RF

Sales Contact
RFSales@wolfspeed.com

RF Product Marketing Contact
RFMarketing@wolfspeed.com

Notes

Disclaimer

Specifications are subject to change without notice. Cree, Inc. believes the information contained within this data sheet to be accurate and reliable. However, no responsibility is assumed by Cree for any infringement of patents or other rights of third parties which may result from its use. No license is granted by implication or otherwise under any patent or patent rights of Cree. Cree makes no warranty, representation or guarantee regarding the suitability of its products for any particular purpose. “Typical” parameters are the average values expected by Cree in large quantities and are provided for information purposes only. These values can and do vary in different applications and actual performance can vary over time. All operating parameters should be validated by customer’s technical experts for each application. Cree products are not designed, intended or authorized for use as components in applications intended for surgical implant into the body or to support or sustain life, in applications in which the failure of the Cree product could result in personal injury or death or in applications for planning, construction, maintenance or direct operation of a nuclear facility.