

Verpackt im Gurt in Anlehnung an DIN IEC 60286-3
 Tape on Reel Packaging according to DIN IEC 60286-3
 Verpackungseinheit: 500 Stück
 Packaging unit: 500 pcs

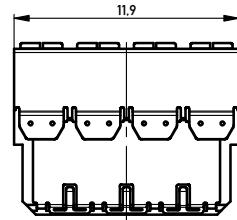

Abspulrichtung - Reel off Direction

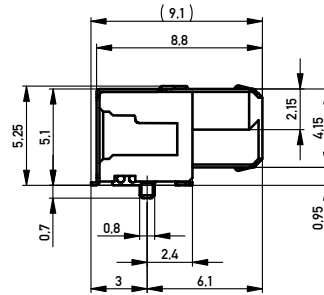
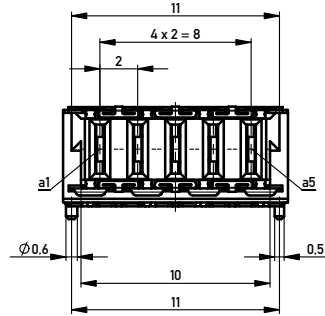
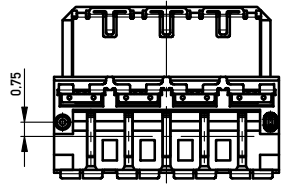
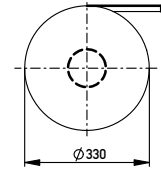
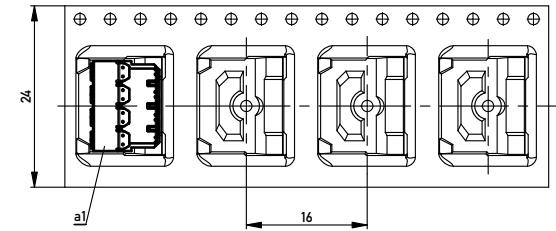

Leiterplatten-Layout Vorschlag / PCB-layout proposal

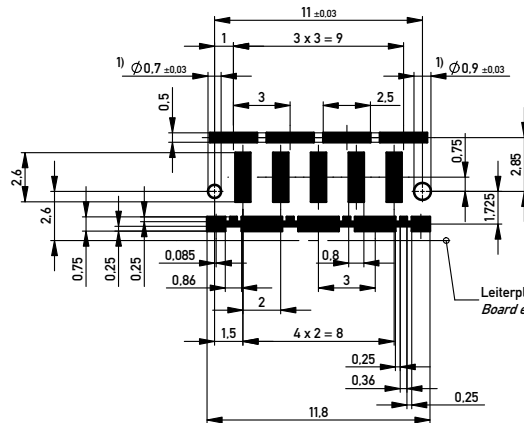

1) Durchmesser des Bohrers /
Drill tool

Leiterplattenkante
Board edge

Für weitere Layout Details bitte
MicroSpeed Applikations Schrift beachten.
For further layout details please consider
MicroSpeed application note.

Anforderungsstufe 1
Performance Level 1

Kontaktbereich vergoldet
Mating Area gold plating

Anschlussbereich verzinkt 4-6 µm
Terminal Area 4-6 µm tin plating

Koplanarität der Anschlüsse ≤ 0.1 mm
Coplanarity Area of Termination ≤ 0.1 mm

Information:		Tolerances		Scale	5:1
All rights reserved. Only for Information. To ensure that this is the latest version of this drawing, please contact one of the ERNI companies before using.		Subject to modification without prior notice. Drawing will not be updated.		Designation	
www.ERNI.com		ERNI		MSpeed Federl. 90° PM SMD MSpeed female 90° PM SMD	
d	27.05.2015	Date		364709	
Index	Date	Class		MSPPM	
				I A2	

Copyright by ERNI Production GmbH & Co. KG
Proprietary notice pursuant to §91 1009, to be observed