

bq24257, bq24258 2-A Single Input I²C, Standalone Switch-Mode Li-Ion/LiFePO₄ Battery Charger with Integrated Current-Sense Resistor

1 Features

- High-efficiency Switch-mode Charger with Integrated Current Sense Resistor
- BC1.2 D+, D– Detection with Dead Battery Provision (DBP) Pin-to-Sync with External USB-PHI
- USB Charging Compliant
- Selectable Input Current Limit of 100 mA, 150 mA, 500 mA, 900 mA, 1.5 A, and 2 A
- Watchdog Timer with Disable Bit
- Integrated 4.9-V, 50-mA LDO
- Complete System Level Protection
 - Input UVLO, Input Overvoltage Protection (OVP), Battery OVP, Sleep Mode, V_{IN_DPM}
 - Input Current Limit
 - Charge Current Limit
 - Thermal Regulation and Thermal Shutdown
 - Voltage Based, JEITA Compatible NTC Monitoring Input
 - Safety Timer
- In Host Mode, Programmable V_{BATREG}, I_{CHG}, I_{LIM}, V_{IN_DPM}, V_{OVP} and safety timer in host mode (after I²C™ Communication and Before Watchdog Timer Times Out)
- In Standalone Mode, Resistor Programmable I_{CHG}, I_{LIM}, and V_{IN_DPM} in Standalone Mode (before I²C™ Communication and After Watchdog Timer Times Out)
- 20-V Maximum Input Voltage Rating
- 10.5-V Maximum Operating Input Voltage
- Low R_{DS(on)} Integrated Sense Resistor for up to 2-A Charging Rate
- Open Drain Status Outputs
- Synchronous Fixed-frequency PWM Controller Operating at 3 MHz for Small Inductor Support
- AnyBoot Robust Battery Detection Algorithm
- Charge Time Optimizer for Improved Charge Times at any Given Charge Current

2 Applications

- Mobile Phones, Smart Phones
- MP3 Players
- Handheld Devices
- Portable Media Player

3 Description

The bq2425x is a highly integrated single-cell Li-Ion battery charger with integrated current sense resistor targeted for space-limited, portable applications with high capacity batteries. The single cell charger has a single input that operates from either a USB port or AC wall adapter for a versatile solution. BC1.2 compatible D+, D- detection allows for recognition of CDP, DCP, SDP, and non-standard USB adapters. The use of an accessory dead battery provision (DBP) pin allows for the system to sync a dead battery state in order to enable or disable the BC1.2 detection in the event of an external USB-PHI.

The bq24257 has two modes of operation: 1) I²C mode, and 2) Standalone mode. In I²C mode, the host can adjust the charge parameters and monitor the status of the charger operation. In Standalone mode, the external resistor sets the input current limit, charge current limit, and the input DPM level. This mode also serves as the default settings when a DCP adapter is present. The bq24257 enters host mode while the I²C registers are accessed and the watchdog timer has not expired (if enabled).

Device Information⁽¹⁾

PART NUMBER	PACKAGE	BODY SIZE (NOM)
bq24257	QFN (24)	4.15 mm x 4.15 mm
	YFF (30)	2.027 mm x 2.427 mm
bq24258 (Product Preview)	QFN (24)	4.15 mm x 4.15 mm
	YFF (30)	2.027 mm x 2.427 mm

(1) For all available packages, see the orderable addendum at the end of the datasheet.

Simplified Schematic for bq24257

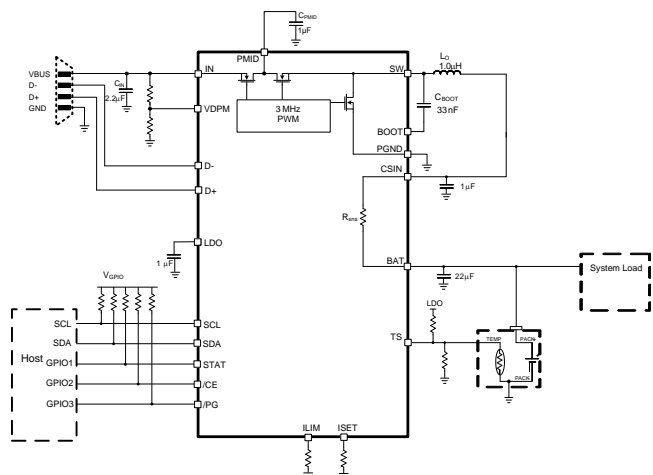

Table of Contents

1 Features	1	9.6 Typical Characteristics	11
2 Applications	1	10 Detailed Description	14
3 Description	1	10.1 Overview	14
4 Revision History	2	10.2 Functional Block Diagram	15
5 Description(cont.)	2	10.3 Feature Description.....	16
6 Device and Documentation Support	2	10.4 Device Functional Modes.....	29
6.1 Trademarks	2	10.5 Register Maps.....	31
6.2 Electrostatic Discharge Caution.....	3	11 Application and Implementation	37
7 Device Comparison Table	3	11.1 Application Information.....	37
8 Pin Configuration and Functions YFF package status from preview to final.....	3	11.2 Typical Application	38
9 Specifications	5	12 Power Supply Recommendations	41
9.1 ABSOLUTE MAXIMUM RATINGS	5	13 Layout	41
9.2 Handling Ratings	5	13.1 Layout Guidelines	41
9.3 RECOMMENDED OPERATING CONDITIONS	6	13.2 Layout Example	41
9.4 Thermal Information	6	13.3 Device and Documentation Support	42
9.5 ELECTRICAL CHARACTERISTICS.....	7	14 Mechanical, Packaging, and Orderable Information	42

4 Revision History

Changes from Original (February 2013) to Revision A Page

- Changed Changed from a Product Brief to full data sheet..... **1**

Changes from Revision A (March 2013) to Revision B Page

- Changed Changed the Product Preview data sheet

Changes from Revision B (#IMPLIED) to Revision C Page

- Changed datasheet to meet superior datasheet standards. **2**
- Changed YFF package status from preview to final. **3**

5 Description(cont.)

The bq24258 has only one mode of operation which is the Standalone. In this mode, the external resistor sets the input current limit, charge current limit, and the input DPM level. This mode also serves as the default settings when a DCP adapter is present. The EN1, EN2, and EN3 pin are available in the bq24258 spin to support USB 3.0 compliance.

The battery is charged in four phases: trickle charge, pre-charge, constant current and constant voltage. In all charge phases, an internal control loop monitors the device junction temperature and reduces the charge current if the internal temperature threshold is exceeded. Additionally, a voltage-based, JEITA compatible battery pack thermistor monitoring input (TS) is included that monitors battery temperature for safe charging.

6 Device and Documentation Support

6.1 Trademarks

I²C is a trademark of NXP B.V. Corporation.
All other trademarks are the property of their respective owners.

6.2 Electrostatic Discharge Caution



These devices have limited built-in ESD protection. The leads should be shorted together or the device placed in conductive foam during storage or handling to prevent electrostatic damage to the MOS gates.

7 Device Comparison Table

DEVICE	DEFAULT OVP	D+/D- or EN1, EN2, EN3	DEFAULT V _{OREG}	V _{Lowv}	TS or DBP	Termination ⁽¹⁾	CHEM	I ² C	ADDRESS	DEFAULT USB ILIM
bq24257	6.5 V	D+/D-	4.2 V	3 V	TS	10%	Li / LiPo	Yes	0x6A	100mA
bq24258 (Product Preview)	10.5 V	EN1, EN2, EN3	4.2 V	3 V	TS	10%	LiFePO ₄	No	0x6A	N/A ⁽²⁾

(1) Default behavior unless changed via I²C.

(2) Selectable via the EN1, EN2, EN3 pins.

8 Pin Configuration and Functions

30-Pin DSBGA, 24-Pin QFN
YFF, RGE Package
(Top View)

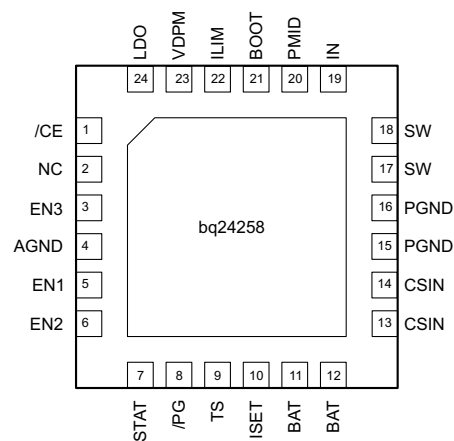
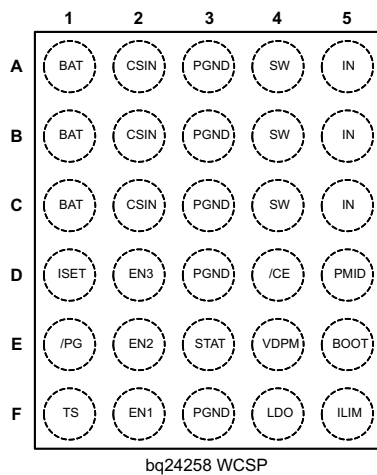
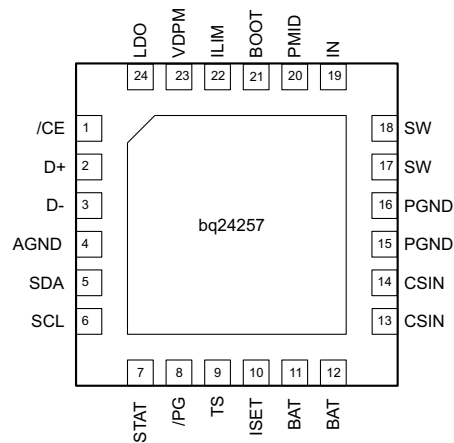
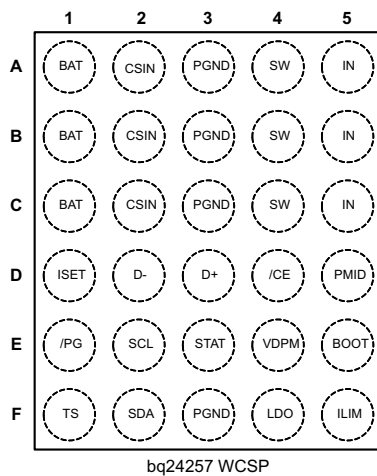

Pin Functions

PIN NAME	bq24257	bq24257	bq24258 (Product Preview)	bq24258 (Product Preview)	I/O	DESCRIPTION
	YFF	RGE	YFF	RGE		
IN	A5,B5,C5	19	A5,B5,C5	19	I	Input power supply. IN is connected to the external DC supply (AC adapter or USB port). Bypass IN to PGND with >2- μ F ceramic capacitor
PMID	D5	20	D5	20	I	Connection between blocking FET and high-side FET. Connect a 1- μ F capacitor from PMID to PGND as close to the PMID and PGND pins as possible
SW	A4,B4,C4	17-18	A4,B4,C4	17-18	O	Inductor Connection. Connect to the switching side of the external inductor.
BOOT	E5	21	E5	21	I	High-Side MOSFET Gate-Driver Supply. Connect a 0.033- μ F ceramic capacitor (voltage rating > 15 V) from BOOT to SW to supply the gate drive for the high-side MOSFETs.
PGND	A3,B3,C3, F3	15-16	A3,B3,C3, D3,F3	15-16		Power Ground terminal. Connect to the ground plane of the circuit. For QFN only, connect to the thermal pad of the device.
CSIN	A2,B2,C2	13-14	A2,B2,C2	13-14	I	System Voltage Sense and SMPS output filter connection. Connect CSIN to the system output at the output bulk capacitors. Bypass CSIN locally with at least 1 μ F.
BAT	A1,B1,C1	11-12	A1,B1,C1	11-12	I/O	Battery Connection. Connect to the positive terminal of the battery. Additionally, bypass BAT with at least 20- μ F capacitor to GND.
TS	F1	9	F1	9	I	Battery Pack NTC Monitor. Connect TS to the center tap of a resistor divider from LDO to GND. The NTC is connected from TS to GND. The TS function provides four thresholds for JEITA or PSE compatibility. See the NTC Monitor section for more details on operation and selecting the resistor values.
VDPM	E4	23	E4	23	I	Input DPM Programming Input. Connect a resistor divider between IN and GND with VDPM connected to the center tap to program the Input Voltage based Dynamic Power Management threshold (VIN_DPM). The input current is reduced to maintain the supply voltage at V _{IN_DPM} . The reference for the regulator is 1.2 V. Short pin to GND if external resistors are not desired—this sets a default of 4.68 V for the input DPM threshold.
ISET	D1	10	D1	10	I	Charge Current Programming Input. Connect a resistor from ISET to GND to program the fast charge current.
ILIM	F5	22	F5	22	I	Input Current Limit Programming Input. Connect a resistor from ILIM to GND to program the input current limit for IN. The current limit is programmable from 0.5 A to 2 A. ILIM has no effect on the USB input. If an external resistor is not desired, short to GND for a 2-A default setting.
$\overline{\text{CE}}$	D4	1	D4	1	I	Charge Enable Active-Low Input. Connect CE to a high logic level to place the battery charger in standby mode.
EN1	--	--	F2	5	I	Input Current Limit Configuration Inputs. Use EN1, EN2, and EN3 to control the maximum input current and enable USB compliance. See Table 1 for programming details.
EN2	--	--	E2	6	I	
EN3	--	--	D2	3	I	
$\overline{\text{PG}}$	E1	8	E1	8	O	Power Good Open Drain Output. $\overline{\text{PG}}$ is pulled low when a valid supply is connected to IN. A valid supply is between VBAT + VS _{LP} and VOVP. If no supply is connected or the supply is out of this range, $\overline{\text{PG}}$ is high impedance.
STAT	E3	7	E3	7	O	Status Output. STAT is an open-drain output that signals charging status and fault interrupts. STAT pulls low during charging. STAT is high impedance when charging is complete or the charger is disabled. When a fault occurs, a 256- μ s pulse is sent out as an interrupt for the host. STAT is enabled/disabled using the EN_STAT bit in the control register. STAT indicates recharge cycles. Connect STAT to a logic rail using an LED for visual indication or through a 10-k Ω resistor to communicate with the host processor.
NC	--	--	--	2		Not connected
SCL	E2	6	--	--	I	I ² C Interface Clock. Connect SCL to the logic rail through a 10-k Ω resistor.
SDA	F2	5			I/O	I ² C Interface Data. Connect SDA to the logic rail through a 10-k Ω resistor.
D+	D3	2	--	--	I	BC1.2 compatible D+/D- Based Adapter Detection. Detects DCP, SDP, and CDP. Also complies with the unconnected dead battery provision clause. D+ and D- are connected to the D+ and D- outputs of the USB port at power up. Also includes the detection of Apple™ and TomTom™ adapters where a 500-mA input current limit is enabled.
D-	D2	3	--	--	I	
LDO	F4	24	F4	24	O	LDO output. LDO is regulated to 4.9 V and drives up to 50 mA. Bypass LDO with a 1- μ F ceramic capacitor. LDO is enabled when V _{UVLO} < V _{IN} < 19 V.
AGND	--	4	--	4		Analog Ground for QFN only. Connect to the thermal pad and the ground plane of the circuit.

9 Specifications

9.1 ABSOLUTE MAXIMUM RATINGS⁽¹⁾

over operating free-air temperature range (unless otherwise noted)

		MIN	MAX	UNIT
Pin voltage range (with respect to PGND)	IN	-1.3	20	V
	SW	-0.7	12	V
	PMID, BOOT	-0.3	20	V
	CSIN, BAT, EN1, EN2, EN3, LDO, SCL, SDA, STAT, D+, D-, \overline{CE} , ISET, ILIM, VDPM	-0.3	7	V
BOOT relative to SW		-0.3	5	V
Output current (continuous)	IN		2	A
	CSIN, BAT		4	A
Output sink current	STAT		5	mA
Operating free-air temperature range		-40	85	°C
Junction temperature, T _J		-40	125	°C

- (1) Stresses beyond those listed under absolute maximum ratings may cause permanent damage to the device. These are stress ratings only, and functional operation of the device at these or any other conditions beyond those indicated under recommended operating conditions is not implied. Exposure to absolute-maximum-rated conditions for extended periods may affect device reliability.

9.2 Handling Ratings

		MIN	MAX	UNIT	
T _{stg}	Storage temperature range	-65	150	°C	
	Lead temperature (soldering, 10 s)		300		
V _(ESD)	Electrostatic discharge	Human body model (HBM), per ANSI/ESDA/JEDEC JS-001, all pins ⁽¹⁾		2	kV
		Charged device model (CDM), per JEDEC specification JESD22-C101, all pins ⁽²⁾		500	V

- (1) JEDEC document JEP155 states that 500-V HBM allows safe manufacturing with a standard ESD control process.
 (2) JEDEC document JEP157 states that 250-V CDM allows safe manufacturing with a standard ESD control process.

9.3 RECOMMENDED OPERATING CONDITIONS

All voltages are with respect to PGND if not specified. Currents are positive into, negative out of the specified pin. Consult Packaging Section of the data book for thermal limitations and considerations of packages.

		MIN	MAX	UNITS
V _{IN}	IN voltage range	4.35	18 ⁽¹⁾	V
	IN operating voltage range (bq24258)	4.35	10.5	
	IN operating voltage range (bq24257)	4.35	6.5	
I _{IN}	Input current		2	A
I _{CHG}	Current in charge mode, BAT		2	A
I _{DISCHG}	Current in discharge mode, BAT		4	A
R _{ISSET}	Charge current programming resistor range	75		Ω
R _{ILIM}	Input current limit programming resistor range	105		Ω
T _J	Operating junction temperature range, T _J	0	125	°C

(1) The inherent switching noise voltage spikes should not exceed the absolute maximum rating on either the BOOT or SW pins. A *tight* layout minimizes switching noise.

9.4 Thermal Information

THERMAL METRIC		bq24257, bq24258	bq24257, bq24258	UNIT
		QFN	YFF	
		24 PINS	30 PINS	
R _{θJA}	Junction-to-ambient thermal resistance	32.9	76.5	°C/W
R _{θJC(top)}	Junction-to-case (top) thermal resistance	32.8	0.2	
R _{θJB}	Junction-to-board thermal resistance	10.6	44.0	
ψ _{JT}	Junction-to-top characterization parameter	0.3	1.6	
ψ _{JB}	Junction-to-board characterization parameter	10.7	43.4	
R _{θJC(bot)}	Junction-to-case (bottom) thermal resistance	2.3	n/a	

9.5 ELECTRICAL CHARACTERISTICS

bq24257 App Circuit, $V_{UVLO} < V_{IN} < V_{OVP}$ AND $V_{IN} > V_{BAT} + V_{SLP}$, $T_J = 0^\circ\text{C} - 125^\circ\text{C}$ and $T_J = 25^\circ\text{C}$ for typical values (unless otherwise noted)

PARAMETER	TEST CONDITIONS	MIN	TYP	MAX	UNIT	
INPUT CURRENTS						
I_{IN}	Supply current from IN	$V_{UVLO} < V_{IN} < V_{OVP}$ and $V_{IN} > V_{BAT} + V_{SLP}$, PWM switching, CE enable	13		mA	
		$V_{UVLO} < V_{IN} < V_{OVP}$ and $V_{IN} > V_{BAT} + V_{SLP}$, PWM switching, CE disable		5		
		$0^\circ\text{C} < T_J < 85^\circ\text{C}$, High-Z Mode		170	225	μA
I_{BAT}	Battery discharge current in high impedance SYSOFF mode, (BAT, SW, CSIN)	$0^\circ\text{C} < T_J < 85^\circ\text{C}$, $V_{BAT} = 4.2\text{ V}$, $V_{IN} = 0\text{ V}$ or 5 V , High-Z Mode	16	22	μA	
		$0^\circ\text{C} < T_J < 85^\circ\text{C}$, $V_{BAT} = 4.2\text{ V}$, $V_{IN} = 0\text{ V}$, SYSOFF Mode		1	μA	
BATTERY CHARGER						
R_{SNS}	Internal battery charger MOSFET on-resistance	Measured from BAT to CSIN, $V_{BAT} = 4.2\text{ V}$ (WCSP)	20	30	$\text{m}\Omega$	
		Measured from BAT to CSIN, $V_{BAT} = 4.2\text{ V}$ (QFN)	30	40		
V_{BATREG}	$I^2\text{C}$ mode	Operating in voltage regulation, Programmable range	3.5	4.44	V	
	SA mode		4.2			
	Voltage regulation accuracy	$T_J = 25^\circ\text{C}$	-0.5%	0.5%		
		$T_J = 0^\circ\text{C}$ to 125°C	-0.75%	0.75%		
I_{CHG}	Fast charge current range	$V_{LOWV} \leq V_{BAT} < V_{BATREG}$	500	2000	mA	
	Fast charge current accuracy	$I^2\text{C}$ mode	-7%	+7%		
I_{CHG_LOW}	Low charge current Setting	Set via $I^2\text{C}$	297	330	363	mA
K_{ISET}	Programmable fast charge current factor	$I_{CHG} = \frac{K_{ISET}}{R_{ISET}}$ ($0.5\text{ A} \leq I_{CHG} < 2\text{ A}$)	232.5	250	267.5	A Ω
V_{ISET}	Maximum ISET pin voltage (in regulation)		0.42		V	
R_{ISET_SHORT}	Short circuit resistance threshold		40	55	75	Ω
V_{LOWV}	Hysteresis for V_{LOWV}	Battery voltage rising bq24257	2.9	3	3.1	V
		Battery voltage falling		100		mV
I_{PRECHG}	Pre-charge current ($V_{BATUVLO} < V_{BAT} < V_{LOWV}$)	Pre-charge is percentile of the external fast charge settings.	8	10	12	% I_{CHG}
V_{BAT_UVLO}	Battery under voltage lockout threshold	VBAT rising	2.37	2.5	2.63	V
	Battery UVLO hysteresis		200			mV
$t_{DGL(LOWV)}$	Deglitch time for pre-charge to fast charge transition		32		ms	
$V_{BATSHRT}$	Battery short threshold	Battery voltage rising	1.9	2	2.1	V
	Hysteresis for $V_{BATSHRT}$	Battery voltage falling		100		mV
$I_{BATSHRT}$	Trickle charge current ($V_{BAT} < V_{BATSHRT}$)		25	35	50	mA
$t_{DGL(BATSHRT)}$	Deglitch time for trickle charge to pre-charge transition		256		μs	
I_{TERM}	Termination current threshold	Termination Current on SA only		10		% I_{CHG}
	Termination current threshold tolerance		-10%		10%	
$t_{DGL(TERM)}$	Deglitch time for charge termination	Both rising and falling, 2-mV overdrive, $t_{RISE}, t_{FALL} = 100\text{ ns}$		64		ms
V_{RCH}	Recharge threshold voltage	Below V_{BATREG}	70	115	160	mV
$t_{DGL(RCH)}$	Deglitch time	V_{BAT} falling below V_{RCH} , $t_{FALL} = 100\text{ ns}$		32		ms

ELECTRICAL CHARACTERISTICS (continued)

bq24257 App Circuit, $V_{UVLO} < V_{IN} < V_{OVP}$ AND $V_{IN} > V_{BAT} + V_{SLP}$, $T_J = 0^{\circ}\text{C} - 125^{\circ}\text{C}$ and $T_J = 25^{\circ}\text{C}$ for typical values (unless otherwise noted)

PARAMETER		TEST CONDITIONS	MIN	TYP	MAX	UNIT
BATTERY CHARGER LiFePO4 (bq24258)						
$V_{REG-OVCHG}$	Over charge voltage regulation		3.76	3.8	3.84	V
$V_{FLT-CHG}$	Float charge regulation		3.46	3.5	3.54	V
V_{OVCHG}	Overcharge comparator for LiFePo	V_{BAT} rising	3.65	3.7	3.75	V
$V_{OVCHG-HYS}$		V_{BAT} falling		300		mV
$t_{DGL(OVCHG)}$	Deglitch on the overcharge comparator			32		ms
BATTERY DETECTION						
V_{BATREG_HI}	Battery detection high regulation voltage	Same as V_{BATREG}		V_{BATREG}		V
V_{BATREG_LO}	Battery detection low regulation voltage	360 mV offset from V_{BATREG}		$V_{BATREG} - 480\text{mV}$		V
V_{BATDET_HI}	Battery detection comparator	$V_{BATREG} = V_{BATREG_HI}$		$V_{BATREG} - 120\text{ mV}$		V
V_{BATDET_LO}	Battery detection comparator	$V_{BATREG} = V_{BATREG_LO}$		$V_{BATREG} + 120\text{ mV}$		V
I_{DETECT}	Battery detection sink current)	Always on during battery detection		7.5		mA
t_{DETECT}	Battery detection time	For both V_{BATREG_HI} and V_{BATREG_LO}		32		ms
T_{safe}	Safety timer accuracy		-10%		10%	
INPUT PROTECTION						
I_{IN}	Input current limiting	$I_{IN_LIMIT} = 100\text{ mA}$	90	95	100	mA
		$I_{IN_LIMIT} = 150\text{ mA}$	135	142.5	150	
		$I_{IN_LIMIT} = 500\text{ mA}$	450	475	500	
		$I_{IN_LIMIT} = 900\text{ mA}$	810	860	910	
		$I_{IN_LIMIT} = 1500\text{ mA}$	1400	1475	1550	
		$I_{IN_LIMIT} = 2000\text{ mA}$	1850	1950	2050	
		$I_{IN_LIMIT} = \text{External}$	$I_{LIM} = \frac{K_{ILIM}}{R_{ILIM}}$			
I_{LIM}	Maximum input current limit programmable range for IN input		500		2000	mA
K_{ILIM}	Maximum input current factor for IN input	$I_{LIM} = 500\text{ mA to } 2\text{ A}$	240	270	300	A Ω
V_{ILIM}	Maximum ILIM pin voltage (in regulation)			0.42		V
$R_{ILIM-SHORT}$	Short circuit resistance threshold		55	83	105	Ω
V_{IN_DPM}	V_{IN_DPM} threshold range	SA mode	4.2		10	V
		I ² C mode	4.2		4.76	V
	V_{IN_DPM} threshold accuracy	Both I ² C and SA mode	-2%		2%	
V_{REF_DPM}	DPM regulation voltage	External resistor setting only	1.15	1.2	1.25	V
V_{DPM_SHRT}	V_{IN_DPM} short threshold	If VDPM is shorted to ground, V_{IN_DPM} threshold will use internal default value		0.3		V
V_{UVLO}	IC active threshold voltage	V_{IN} rising	3.15	3.35	3.5	V
	IC active hysteresis	V_{IN} falling from above V_{UVLO}		175		mV
V_{SLP}	Sleep-mode entry threshold, $V_{SUPPLY-VBAT}$	V_{IN} falling	0	50	100	mV
	Sleep-mode exit hysteresis	V_{IN} rising	40	100	160	mV
$t_{DGL(SLP)}$	Deglitch time for supply rising above $V_{SLP} + V_{SLP_EXIT}$	Rising voltage, 2-mV over drive, $t_{RISE} = 100\text{ns}$		32		ms
V_{OVP}	Input supply OVP threshold voltage (bq24258)	IN rising	IN_OVP -200mV	IN_OVP	IN_OVP +200mV	V
	Input supply OVP threshold voltage (bq24257)	IN rising	IN_OVP -200mV	IN_OVP	IN_OVP +200mV	
	V_{OVP} hysteresis	IN falling from V_{OVP}		100	6.8	mV

ELECTRICAL CHARACTERISTICS (continued)

bq24257 App Circuit, $V_{UVLO} < V_{IN} < V_{OVP}$ AND $V_{IN} > V_{BAT} + V_{SLP}$, $T_J = 0^\circ\text{C} - 125^\circ\text{C}$ and $T_J = 25^\circ\text{C}$ for typical values (unless otherwise noted)

PARAMETER		TEST CONDITIONS	MIN	TYP	MAX	UNIT
$t_{DGL(OVP)}$	Deglintch time for IN Rising above VOVP	IN rising voltage, $t_{RISE} = 100\text{ns}$		32		ms
V_{BOVP}	Battery OVP threshold voltage	VBAT threshold over V_{BATREG} to turn off charger during charge	102.5	105	107.5	% V_{BATREG}
	V_{BATOVP} hysteresis	Lower limit for V_{BAT} falling from above V_{BOVP}		1		
$t_{DGL(BOVP)}$	BOVP Deglitch	Battery entering/exiting BOVP		1		ms
PWM CONVERTER						
$R_{ON(BLK)}$	Internal blocking MOSFET on-resistance	Measured from IN to PMID (WCSP and QFN)		60	100	m Ω
$R_{ON(HS)}$	Internal high-side MOSFET on-resistance	Measured from PMID to SW (WCSP and QFN)		100	150	m Ω
$R_{ON(LS)}$	Internal low-side MOSFET on-resistance	Measured from SW to PGND (WCSP and QFN)		110	165	m Ω
I_{CBC}	Cycle-by-cycle current limit		2.6	3.2	3.8	A
f_{OSC}	Oscillator frequency		2.7	3	3.3	MHz
D_{MAX}	Maximum duty cycle			95%		
D_{MIN}	Minimum duty cycle		0%			
T_{SHTDWN}	Thermal trip			150		$^\circ\text{C}$
	Thermal hysteresis			10		
T_{REG}	Thermal regulation threshold	Charge current begins to cut off		125		
LDO						
V_{LDO}	LDO output voltage	$V_{IN} = 5.5\text{V}$, $I_{LDO} = 0$ to 50 mA	4.65	4.95	5.25	V
I_{LDO}	Maximum LDO output current		50			mA
V_{LDO}	LDO dropout voltage ($V_{IN} - V_{LDO}$)	$V_{IN} = 5\text{V}$, $I_{LDO} = 50\text{mA}$		200	300	mV
BATTERY-PACK NTC MONITOR						
V_{HOT}	High temperature threshold	V_{TS} falling	29.6	30	30.4	% V_{LDO}
$V_{HYS(HOT)}$	Hysteresis on high threshold	V_{TS} rising		1		
V_{WARM}	Warm temperature threshold	V_{TS} falling	37.9	38.3	38.7	% V_{LDO}
$V_{HYS(WARM)}$	Hysteresis on warm temperature threshold	V_{TS} rising		1		
V_{COOL}	Cool temperature threshold	V_{TS} rising	56.5	56.5	56.9	% V_{LDO}
$V_{HYS(COOL)}$	Hysteresis on cool temperature threshold	V_{TS} falling		1		
V_{COLD}	Low temperature threshold	V_{TS} rising	59.6	60	60.4	% V_{LDO}
$V_{HYS(COLD)}$	Hysteresis on low threshold	V_{TS} falling		1		
V_{TS_DIS}	TS disable threshold		70		73	% V_{LDO}
$t_{DGL(TS)}$	Deglitch time on TS change			32		ms
INPUTS (DBP, EN1, EN2, EN3, \overline{CE}, SCL, SDA)						
V_{IH}	Input high threshold		1			V
V_{IL}	Input low threshold				0.4	V
STATUS OUTPUTS (STAT, \overline{PG}, \overline{CHG})						
V_{OL}	Low-level output saturation voltage	$I_O = 5\text{mA}$, sink current			0.4	V
I_{IH}	High-level leakage current	Hi-Z and 5 V applies			1	μA
TIMERS						
t_{SAFETY}	45 min safety timer			2700		s
	6 hr safety timer			21600		s
	9 hr safety timer			32400		s
$t_{WATCH-DOG}$	Watch dog timer			50		s

ELECTRICAL CHARACTERISTICS (continued)

bq24257 App Circuit, $V_{UVLO} < V_{IN} < V_{OVP}$ AND $V_{IN} > V_{BAT} + V_{SLP}$, $T_J = 0^\circ\text{C} - 125^\circ\text{C}$ and $T_J = 25^\circ\text{C}$ for typical values (unless otherwise noted)

PARAMETER		TEST CONDITIONS	MIN	TYP	MAX	UNIT
D+, D- DETECTION						
I_{DP_SRC}	D+ current source for DCD	DCD	7		13	μA
R_{DM_DWN}	D- pull-down resistance for DCD	DCD	14.25		24.8	$\text{k}\Omega$
V_{DP_LOW}	D+ low comparator threshold for DCD	DCD	0.85	0.9	0.95	V
V_{DP_SRC}	D+ source voltage for primary detection	Primary Detection	0.5	0.6	0.7	V
$I_{DP_SRC_PD}$	D+ source voltage output current for primary detection	Primary Detection	200			μA
I_{DM_SINK}	D- sink current for primary detection	Primary Detection	50	100	150	μA
V_{DAT_REF}	Primary detection threshold	Primary Detection	250	325	400	mV
V_{LGC}	Primary detection threshold	Primary Detection	0.85	0.9	0.95	V
V_{DM_SRC}	D- source voltage for Secondary Detection	Secondary Detection	0.5	0.6	0.7	V
$I_{DM_SRC_PD}$	D- source voltage output current for secondary detection	Secondary Detection	200			μA
I_{DP_SINK}	D+ sink current for secondary detection	Secondary Detection	50	100	150	μA
V_{DAT_REF}	Secondary detection threshold	Secondary Detection	250	325	400	mV
V_{ATT_LO}	Apple/TomTom detection low threshold	Apple, TomTom Detection	1.8	1.85	1.975	V
V_{ATT_HI}	Apple/TomTom detection high threshold	Apple, TomTom Detection	3.2	3.5	4.05	V
C_I	Input capacitance	D-, switch open		4.5		pF
		D+, switch open		4.5		pF
I_{D_LKG}	Leakage current into D+/D-	D-, switch open	-1		1	μA
		D+, switch open	-1		1	μA

9.6 Typical Characteristics

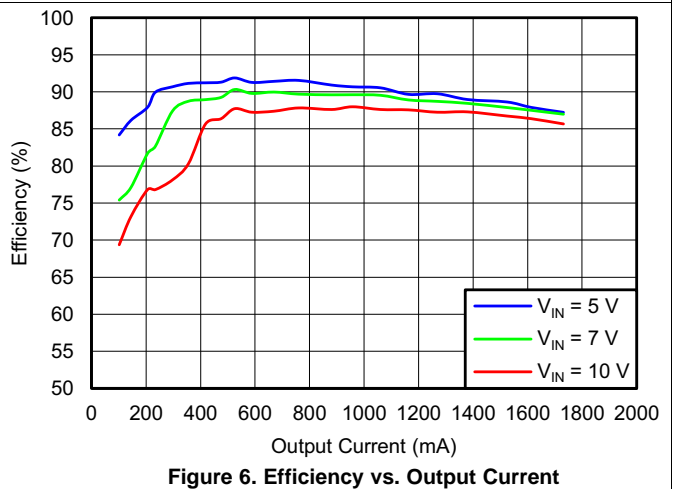
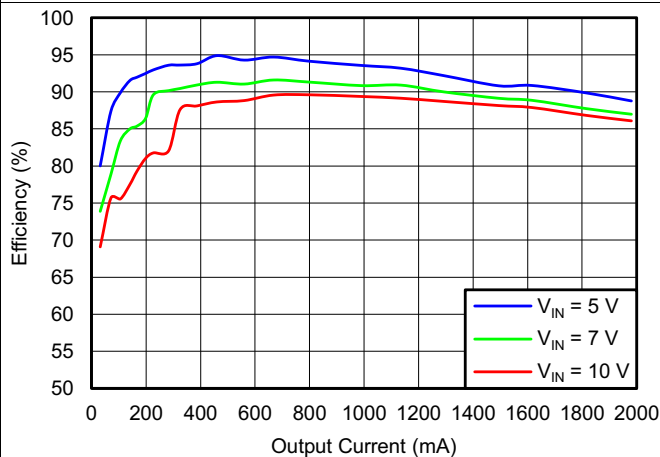
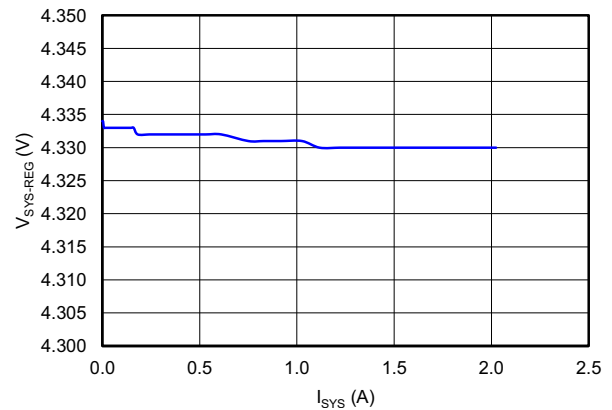
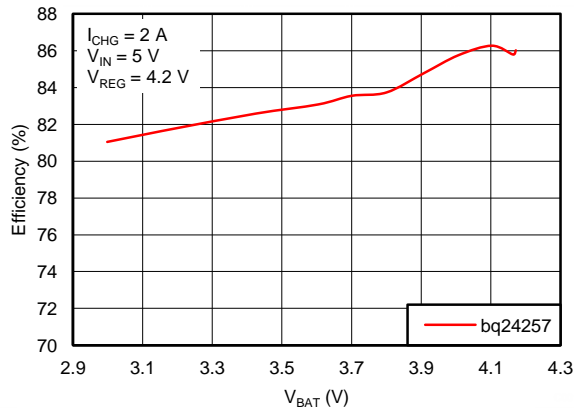
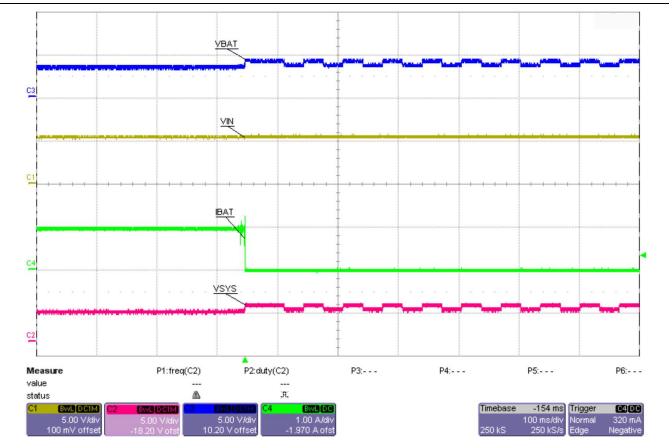
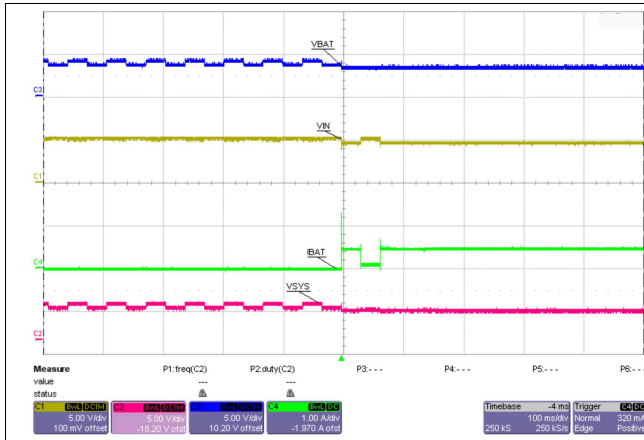

Typical Characteristics (continued)

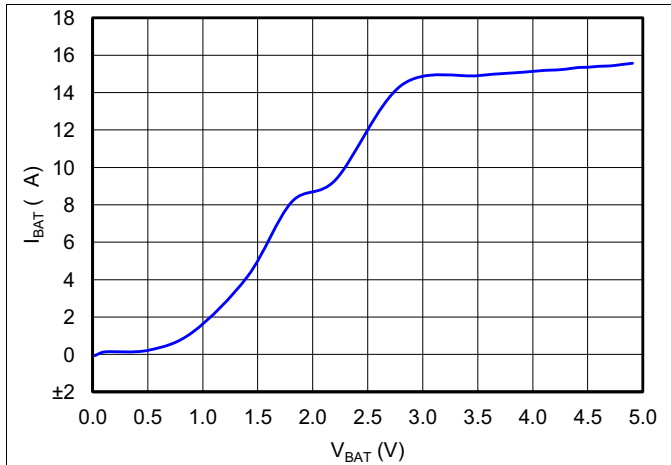

Figure 7. V_{BAT} IQ vs. I_{BAT}

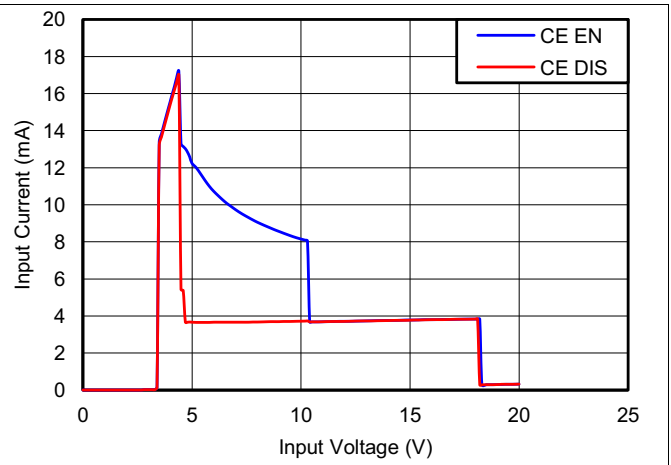

Figure 8. Input IQ with Charge DIS and EN

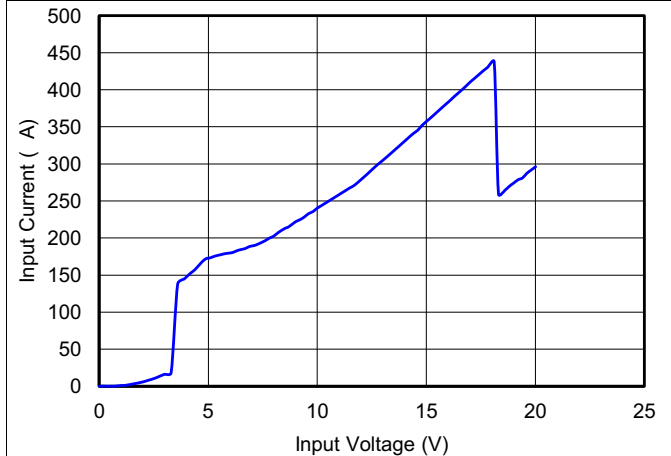

Figure 9. Input IQ with Charge Enable and Hz

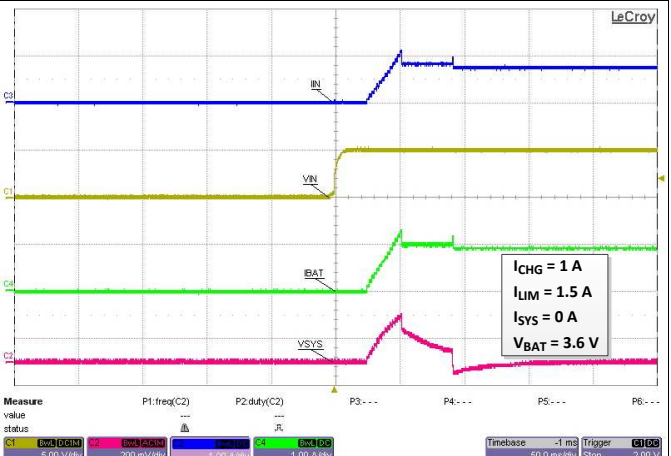

Figure 10. Startup

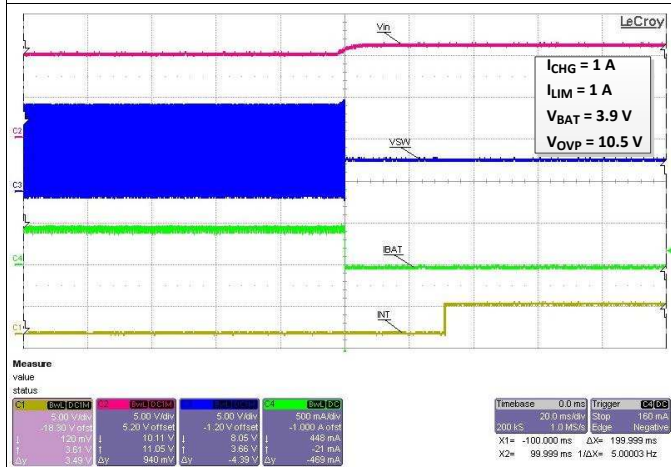

Figure 11. Input OVP Event with INT

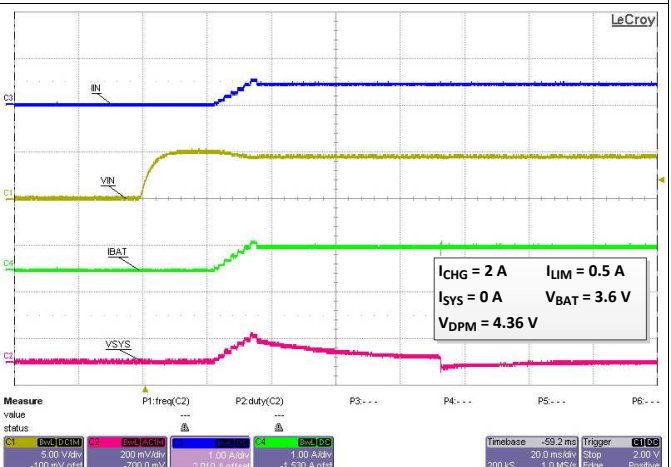
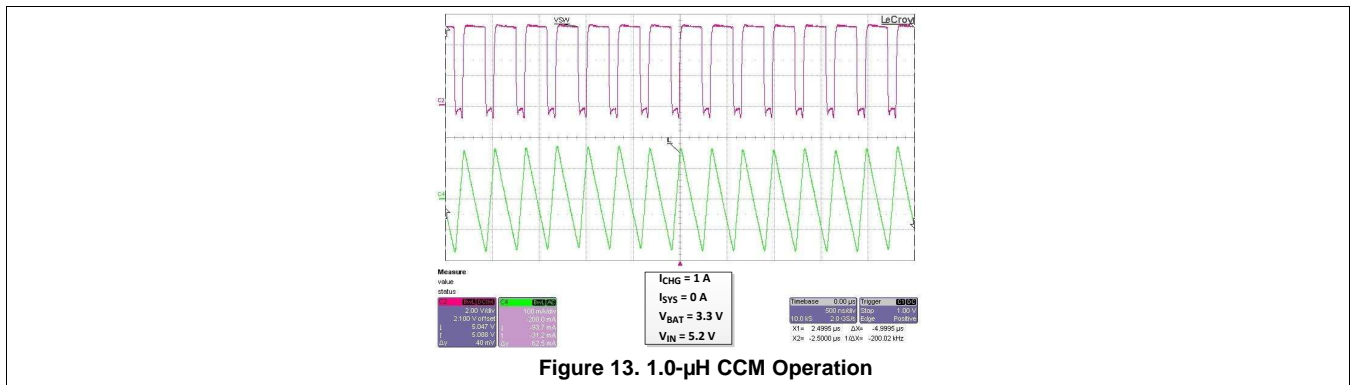

Figure 12. V_{DPM} Startup, 4.2 V

Typical Characteristics (continued)



10 Detailed Description

10.1 Overview

The bq24257 is a highly-integrated, single-cell, Li-Ion battery charger with integrated current sense resistors targeted for space-limited, portable applications with high-capacity batteries. The single-cell charger has a single input that operates from either a USB port or AC wall adapter for a versatile solution.

The bq24257 device has two modes of operation:

1. I²C Mode
2. Standalone Mode

In I²C mode, the host adjusts the charge parameters and monitors the status of the charger operation. In standalone mode, the external resistor sets the input-current limit, and charge current limit. Standalone mode also serves as the default settings when a DCP adapter is present. It enters host mode while the I²C registers are accessed and the watchdog timer has not expired (if enabled). The battery is charged in four phases: trickle charge, pre-charge, constant current and constant voltage. In all charge phases, an internal control loop monitors the device junction temperature and reduces the charge current if the internal temperature threshold is exceeded.

10.3 Feature Description

10.3.1 EN1, EN2, EN3 Pins

If the D+, D- detection pins are not used (bq24257), input current limit can be programmed through the host. The EN1, EN2, and EN3 pins are available in the bq24258 spin to support USB 3.0 compliance. When the input current limit pins change state, the VIN_DPM threshold changes as well. See [Table 1](#) for details:

Table 1. EN1, and EN2 Truth Table⁽¹⁾

EN3	EN2	EN1	INPUT CURRENT LIMIT	VINDPM THRESHOLD
0	0	0	500mA	4.36V
0	0	1	Externally programmed by ILIM (up to 2.0A)	Externally programmed VDPM
0	1	0	100mA	4.36V
0	1	1	Input Hi-Z	None
1	0	0	900mA	4.36V
1	0	1	Externally programmed by ILIM (up to 2.0 A)	Externally programmed VDPM
1	1	0	150mA	4.36V
1	1	1	Input Hi-Z	None

(1) If EN3 = 0, it will be USB 2.0 compliant; If EN3 = 1, USB 3.0 compliant.

10.3.2 I²C and Stand Alone Operation

The bq24257 series offers a unique feature when compared to traditional host mode chargers—the default input current limit, output current limit and VIN_DPM parameters can be set via external resistors. In traditional host mode chargers, the default parameters are programmed during manufacturing to set the I²C registers at a specific default. If an end application calls for an alternate default setting, the traditional charger is left with the only option of changing the parameters at the manufacturing stage. This may not always be acceptable.

Figure 14 illustrates the behavior of the bq24257 when transitioning between I²C mode and stand alone mode (except for the bq24257).

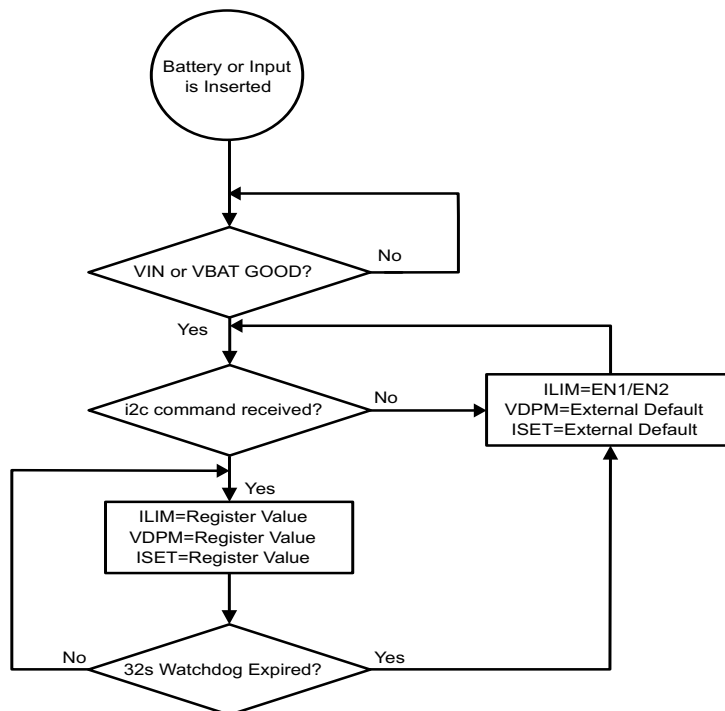

Figure 14. I²C and Stand Alone Mode Handoff

Once the battery or input is inserted and above the good thresholds, the device will determine if an I²C command has been received in order to discern whether to operate from the I²C registers or the external settings. Note that the bq24257 does not have EN1/EN2 pins and therefore the input current limit will be based on the D+/D– results. When in host mode (I²C operation), the device will enter stand alone operation once the watchdog timer expires.

10.3.2.1 External Settings: ISET, ILIM and VIN_DPM

The fast charge current resistor (R_{ISET}) can be set by using the following formula:

$$R_{ISET} = \frac{K_{ISET}}{I_{FC}} = \frac{250}{I_{FC}} \quad (1)$$

Where I_{FC} is the desired fast charge current setting in Amperes.

The input current limit resistor (R_{ILIM}) can be set by using the following formula:

$$R_{ILIM} = \frac{K_{ILIM}}{I_C} = \frac{270}{I_C} \quad (2)$$

Where I_C is the desired input current limit in Amperes.

Based on the application diagram reference designators, the resistor R_1 and R_2 can be calculated as follows to set V_{IN_DPM} :

$$V_{IN_DPM} = V_{REF_DPM} \times \frac{R_1 + R_2}{R_2} = 1.2 \times \frac{R_1 + R_2}{R_2} \quad (3)$$

V_{IN_DPM} should be chosen first along with R_1 . Choosing R_1 first will ensure that R_2 will be greater than the resistance chosen. This is the case since V_{IN_DPM} should be chosen to be greater than $2 \times V_{REF_DPM}$.

If resistors are not desired for BOM count reduction, the VDPM and the ILIM pins can be shorted to set the internal defaults. However, the ISET resistor must be populated as this will be interpreted as a fault. [Table 2](#) summarizes the settings when the ILIM, ISET, and V_{IN_DPM} pins are shorted to GND.

Table 2. ILIM, VDPM, and ISET Short Behaviors

PIN SHORTED	BEHAVIOR
ILIM	Input current limit = 2 A
VDPM	$V_{IN_DPM} = 4.68$ V
ISET	Fault—charging suspended

10.3.3 BC1.2 D+/D– Detection

The bq24257 includes a fully BC1.2 compatible D+/D– source detection. This detection supports the following types of ports:

- DCP (dedicated charge port)
- CDP (charging downstream port)
- SDP (standard downstream port)
- Apple™/TomTom™ ports

This D+/D– detection algorithm does not support ACA (accessory charge adapter) identification, but the input current will default to 500mA when a charge port is attached to the ACA and bq24257 is connected to the OTG port.

The D+/D– detection algorithm is only active when the device is in standalone mode (e.g. the host is not communicating with the device and the watch dog timer has expired). However, when the device is in host mode (that is, host is communicating via I²C to the device) writing a '1' to register 0x04 bit location 4 (DPDM_EN) forces the device to perform a D+/D– detection on the next power port insertion. This allows the D+/D– detection to be enabled in both host mode and default mode.

The D+/D– detection algorithm has 5 primary states. These states are termed the following:

1. Data Contact Detect
2. Primary Detection
3. Secondary Detection
4. Non-standard Adapter Detection (for Apple™ / TomTom™)
5. Detection Configuration

The DCD state determines if the device has properly connected to the D+/D– lines. If the device is not in host mode and VBUS is inserted (or DPDM_EN is true) the device will enter the DCD state and enable the appropriate algorithm. If the DCD timer expires, the device will enter the Non-standard Adapter Detection (for Apple™ / TomTom™) state. Otherwise it will enter the Primary Detection state.

When entering the Primary Detection state, the appropriate algorithm is enabled to determine whether to enter the secondary detection state for DCP and CDP or the secondary detection state for SDP/Non-Standard adapters.

The non-standard adapter detection state for Apple™ / TomTom™ tests for the unique conditions for these non-standard adapters. If the algorithm passes the unique conditions found with these adapters, it will proceed to the Detection Configuration state. Otherwise it will revert back to the primary detection state.

The secondary detection state determines whether the input port is a DCP, CDP, SDP, or other non-standard adapters. If the Primary Detection state indicated that the input port is either a DCP or CDP, the device will enable the appropriate algorithm to differentiate between the two. If the Primary Detection state indicated that the input port is either a SDP or non-standard adapter, the device will enable the appropriate algorithm to differentiate between these two ports. Once complete, the device will continue to the Detection Configuration state.

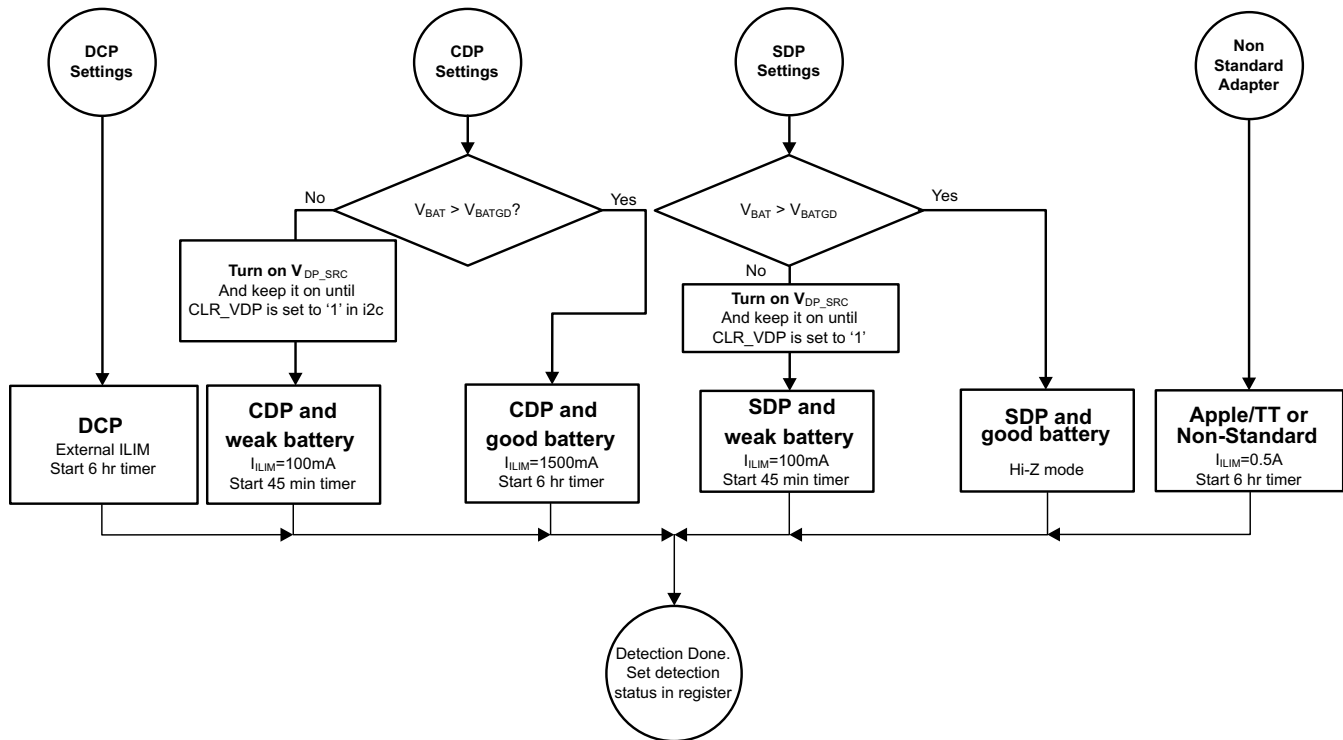

Figure 15. Detection Configuration State

The detection configuration state sets the input current limit of the device along with the charge timer. The exception to the CDP and the SDP settings are due to the Dead Battery Provision (DBP) clause for unconnected devices. This clause states that the device can pull a maximum of 100mA when not connected due to a dead battery. During the battery wakeup time, the device sources a voltage on the D+ pin in order to comply with the DBP clause. Once the battery is good, the system can clear the D+ pin voltage by writing a '1' to address 0x07 bit position 4 (CLR_VDP). The device must connect to the host within 1sec of clearing the D+ pin voltage per the DPB clause.

A summary of the input current limits and timer configurations for each charge port type are found in Table 3.

Table 3. D+, D– Detection Results per Charge Port Type

CHARGE PORT TYPE	INPUT CURRENT LIMIT	CHARGE TIMER
DCP	External ILIM	6 hours
CDP Dead Battery	100 mA	45 minutes
CDP Good Battery	1500 mA	6 hours
SDP Dead Battery	100 mA	45 minutes
SDP Good Battery	Hi-Z	N/A
Non-Standard	500 mA	6 hours

10.3.4 Transient Response

The bq2425x includes an advanced hybrid switch mode control architecture. When the device is regulating the charge current (fast-charge), a traditional voltage mode control loop is used with a Type-3 compensation network. However, the bq2425x switches to a current mode control loop when the device enters voltage regulation. Voltage regulation occurs in two charging conditions: 1) Battery voltage regulation ($I_{BAT} < I_{CHG}$), and 2) Charge Done. This architecture allows for superior transient performance when regulating the voltage due to the simplification of the compensation when using current mode control. The below transient response plot illustrates a 0 A to 2-A load step with 4.7 ms full cycle and 12% duty cycle. A 3.9 V Li-Ion battery is used. The input voltage is set to 5 V, charge current is set to 0.5 A and the input current is limited to 0.5 A. Note that a high line impedance input supply was used to indicate a realistic input scenario (adapter and cable). This is illustrated by the change in V_{IN} seen at the input of the IC.

The figure shows a ringing at both the input voltage and the input current. This is caused by the input current limit speed up comparator.

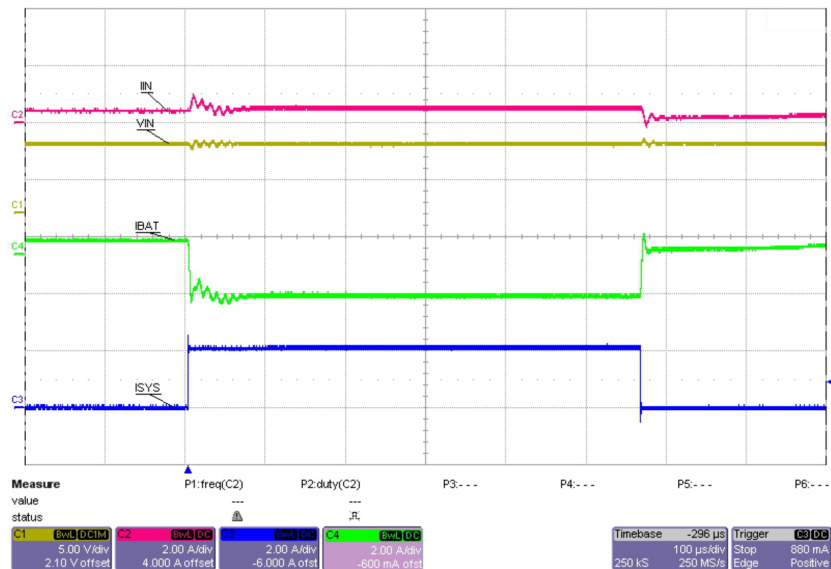

Figure 16. 2A Load step Transient

10.3.5 AnyBoot Battery Detection

The bq24257 includes a sophisticated battery detection algorithm used to provide the system with the proper status of the battery connection. The AnyBoot battery algorithm also guarantees the detection of voltage based battery protectors that may have a long closure time (due to the hysteresis of the protection switch and the cell capacity). The AnyBoot battery detection algorithm utilizes a dual-voltage based detection methodology where the csin rail will switch between two primary voltage levels. The period of the voltage level shift is 64ms and therefore the power supply rejection of the down-system electronics will see this shift as essentially DC.

The AnyBoot algorithm has essentially 3 states. The 1st state is used to determine if the device has terminated with a battery attached. If it has terminated due to the battery not being present, then the algorithm moves to the 2nd and 3rd states. The 2nd and 3rd states shift the csin voltage level between 4.2V and 3.72V. In each state there are comparator checks to determine if a battery has been inserted. The two states guarantee the detection of a battery even if the voltage of the cell is at the same level of the comparator thresholds. The algorithm will remain in states 2 and 3 until a battery has been inserted. The flow diagram details for the Anyboot algorithm are shown in [Figure 17](#).

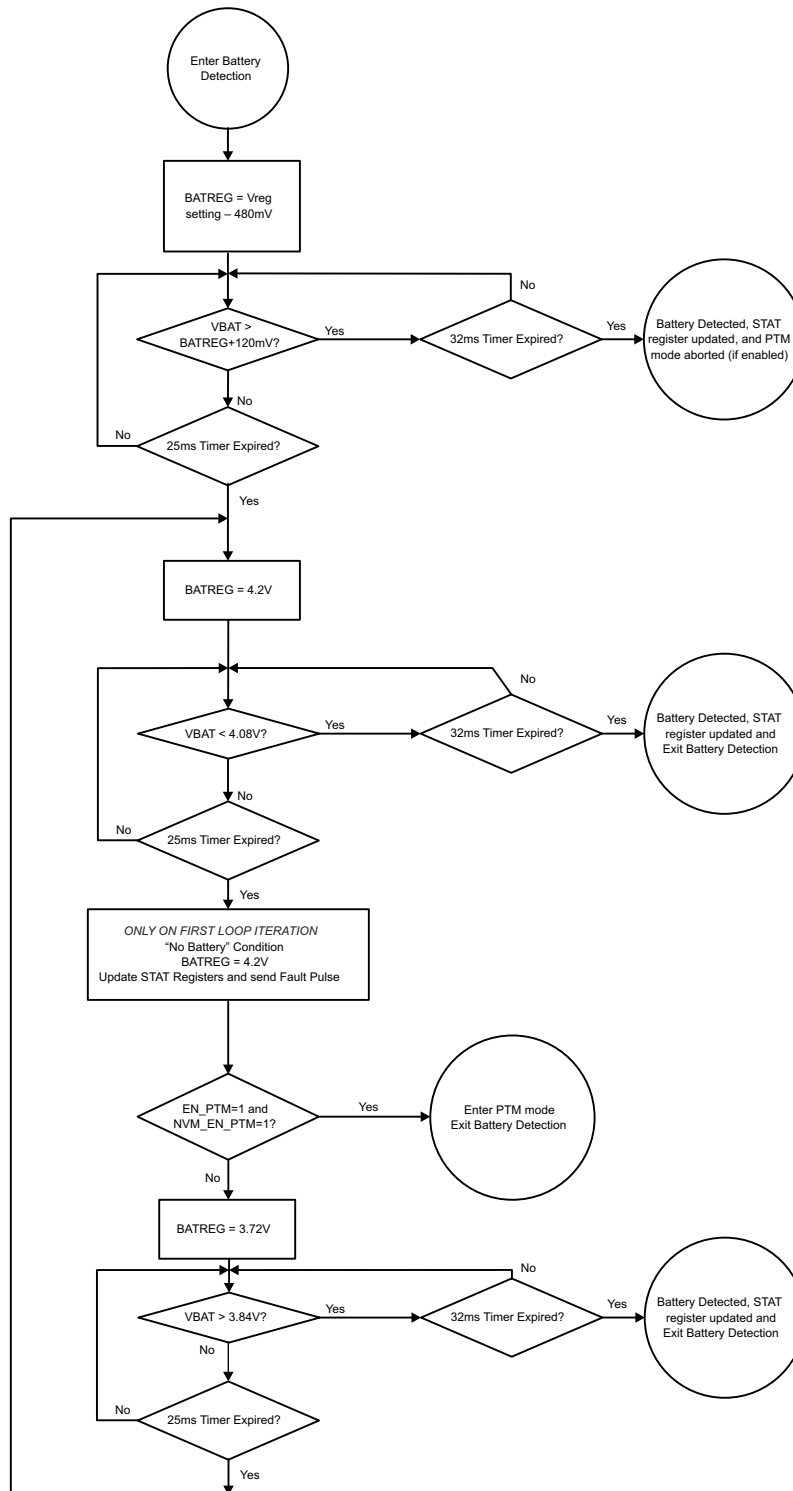

Figure 17. AnyBoot Battery Detection Flow Diagram

10.3.5.1 Input Voltage Based DPM

During normal charging process, if the input power source is not able to support the programmed or default charging current, the supply voltage decreases. Once the supply drops to V_{IN_DPM} , the input current limit is reduced down to prevent the further drop of the supply. When the IC enters this mode, the charge current is lower than the set. This feature ensures IC compatibility with adapters with different current capabilities without a hardware change.

10.3.5.2 Sleep Mode

The bq2425x enters the low-power sleep mode if the voltage on V_{IN} falls below sleep-mode entry threshold, $V_{BAT} + V_{SLP}$, and V_{IN} is higher than the under-voltage lockout threshold, V_{UVLO} . This feature prevents draining the battery during the absence of V_{IN} . When $V_{IN} < V_{BAT} + V_{SLP}$, the bq2425x turns off the PWM converter, turns on the battery FET, sends a single 256 μ s pulse is sent on the STAT output and the FAULT/STAT bits of the status registers are updated in the I²C. Once $V_{IN} > V_{BAT} + V_{SLP}$ with the hysteresis, the FAULT bits are cleared and the device initiates a new charge cycle.

10.3.5.3 Hiz Mode

Set the HZ_MODE bit to 1 to put the device in Hiz mode. In Hiz, the charger device is in low-power standby mode and the switch mode controller is disabled.

10.3.5.4 Input Over-Voltage Protection

The bq2425x provides over-voltage protection on the input that protects downstream circuitry. The built-in input over-voltage protection to protect the device and other components against damage from over voltage on the input supply (Voltage from V_{IN} to PGND). When $V_{IN} > V_{OVP}$, the bq2425x turns off the PWM converter, turns the battery FET, sends a single 256 μ s pulse is sent on the STAT output and the FAULT/STAT bits of the status registers and the battery/supply status registers are updated in the I²C. Once the OVP fault is removed, the FAULT bits are cleared and the device returns to normal operation. The OVP threshold for the bq2425x is programmable from 6.5 V to 10.5 V using V_{OVP} bits in register #7.

10.3.5.5 NTC Monitor (contact the local TI representative for function availability)

The bq24257 includes the integration of an NTC monitor pin that complies with the JEITA specification (PSE also available upon request). The voltage based NTC monitor allows for the use of any NTC resistor with the use of the circuit shown below:

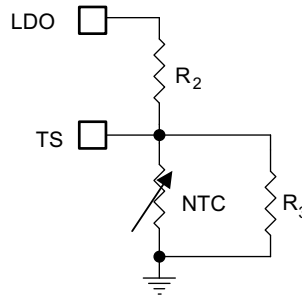

Figure 18. Voltage Based NTC Circuit

The use of R3 is only necessary when the NTC does not have a beta near 3500K. When deviating from this beta, error will be introduced in the actual temperature trip thresholds. The trip thresholds are summarized below which are typical values provided in the specification table.

Table 4. Ratiometric TS Trip Thresholds for JEITA Compliant Charging

V_{HOT}	30.0%
V_{WARM}	38.3%
V_{COOL}	56.5%
V_{COLD}	60%

When sizing for R2 and R3, it is best to solve two simultaneous equations that ensure the temperature profile of the NTC network will cross the V_{HOT} and V_{COLD} thresholds. The accuracy of the V_{WARM} and V_{COOL} thresholds will depend on the beta of the chosen NTC resistor. The two simultaneous equations are shown below:

$$\%V_{COLD} = \frac{\left(\frac{R_3 R_{NTC}|_{TCOLD}}{R_3 + R_{NTC}|_{TCOLD}} \right)}{\left(\frac{R_3 R_{NTC}|_{TCOLD}}{R_3 + R_{NTC}|_{TCOLD}} \right) + R_2} \times 100$$

$$\%V_{HOT} = \frac{\left(\frac{R_3 R_{NTC}|_{THOT}}{R_3 + R_{NTC}|_{THOT}} \right)}{\left(\frac{R_3 R_{NTC}|_{THOT}}{R_3 + R_{NTC}|_{THOT}} \right) + R_2} \times 100 \tag{4}$$

Where the NTC resistance at the V_{HOT} and V_{COLD} temperatures must be resolved as follows:

$$R_{NTC}|_{TCOLD} = R_0 e^{\beta \left(\frac{1}{TCOLD} - \frac{1}{T_0} \right)}$$

$$R_{NTC}|_{THOT} = R_0 e^{\beta \left(\frac{1}{THOT} - \frac{1}{T_0} \right)} \tag{5}$$

To be JEITA compliant, T_{COLD} must be 0°C and T_{HOT} must be 60°C. If an NTC resistor is chosen such that the beta is 4000K and the nominal resistance is 10kΩ, the following R2 and R3 values result from the above equations:

$$R_2 = 5 \text{ k}\Omega$$

$$R_3 = 9.82 \text{ k}\Omega$$

Figure 19 illustrates the temperature profile of the NTC network with R2 and R3 set to the above values.

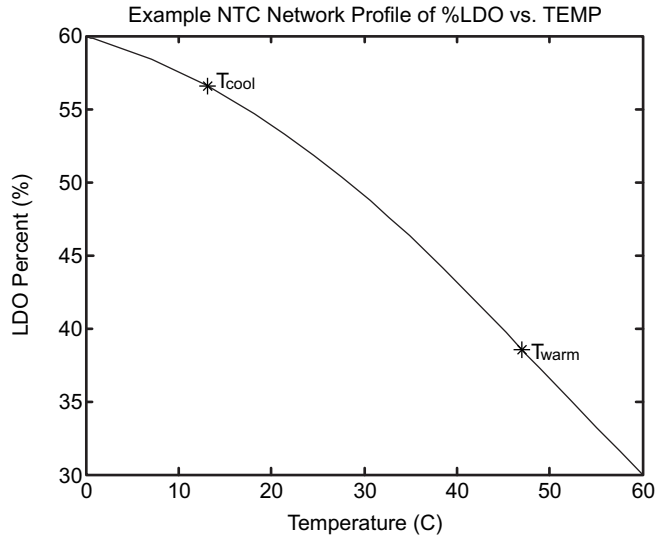

Figure 19. Voltage Based NTC Circuit Temperature Profile

For JEITA compliance, the T_{COOL} and T_{WARM} levels are to be 10°C and 45°C respectively. However, there is some error due to the variation in beta from 3500K. As shown above, the actual temperature points at which the NTC network crosses the V_{COOL} and V_{WARM} are 13°C and 47°C respectively. This error is small but should be considered when choosing the final NTC resistor.

Once the resistors are configured, the internal JEITA algorithm will apply the below profile at each trip point for battery voltage regulation and charge current regulation.

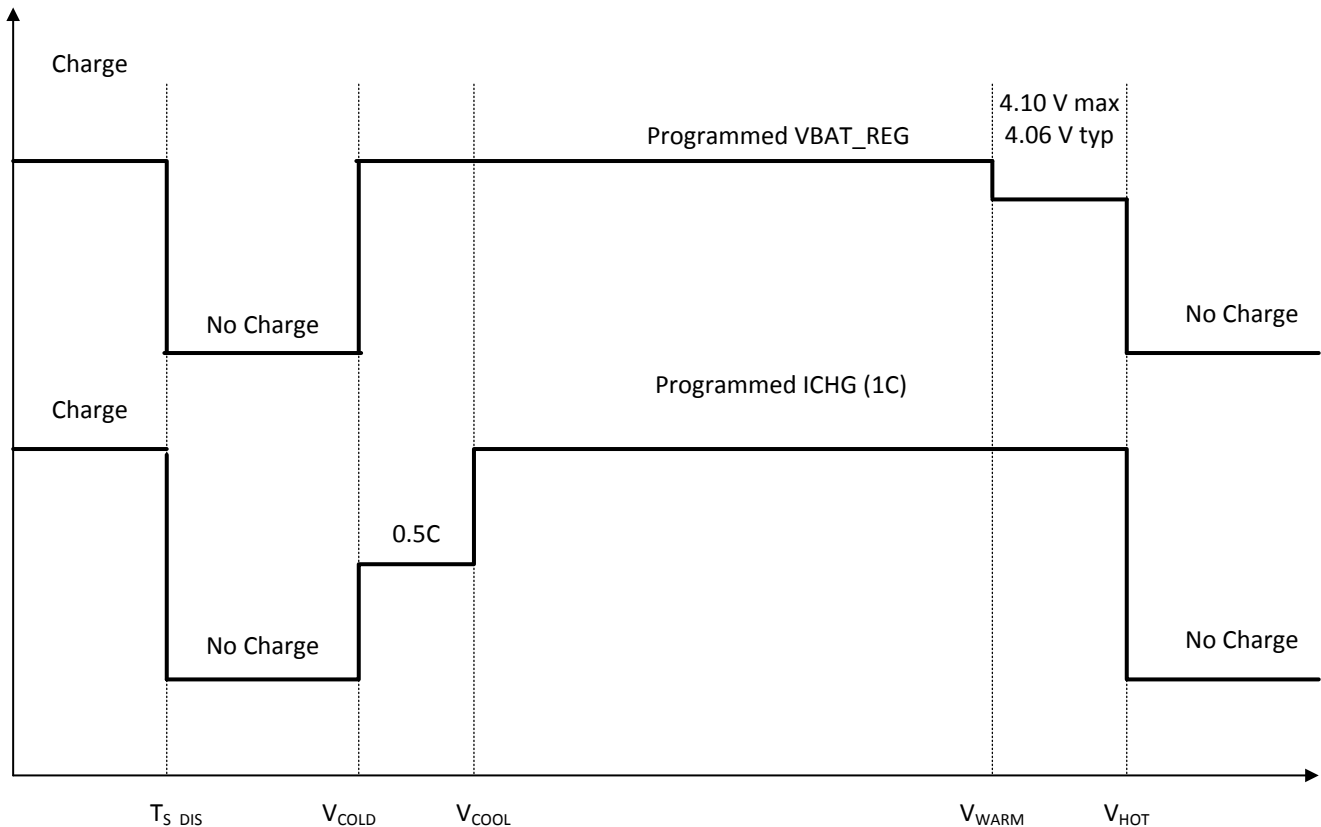

Figure 20. JEITA Profile for Voltage and Current Regulation Loops

10.3.6 Production Test Mode

To aid in end mobile device product manufacturing, the bq24257 includes a Production Test Mode (PTM), where the device is essentially a DC-DC buck converter. In this mode the input current limit to the charger is disabled and the output current limit is limited only by the inductor cycle-by-cycle current (e.g. 3.5A). The PTM mode can be used to test systems with high transient loads such as GSM transmission without the need of a battery being present.

As a means of safety, the Anyboot algorithm will determine if a battery is not present at the output prior to enabling the PTM mode. If a battery is present and the software attempts to enter PTM mode, the device will not enable PTM mode.

10.3.7 Safety Timer

At the beginning of charging process, the bq24257 starts the safety timer. This timer is active during the entire charging process. If charging has not terminated before the safety timer expires, the IC enters suspend mode where charging is disabled. The safety timer time is selectable using the I²C interface. A single 256µs pulse is sent on the STAT output and the FAULT/ bits of the status registers are updated in the I²C.

This function prevents continuous charging of a defective battery if the host fails to reset the safety timer. The safety timer runs at 2x the normal rate under the following conditions: Pre-charge mode, during thermal regulation where the charge current is reduced, during TS fault where the charge current reduced due to temperature rise on the battery, input current limit. The safety timer is suspended during OVP, TS fault where charge is disabled, thermal shut down, and sleep mode.

10.3.8 Fault Modes

The bq2425x family includes several hardware fault detections. This allows for specific conditions that could cause a safety concern to be detected. With this feature, the host can be alleviated from monitoring unsafe charging conditions and also allows for a “fail-safe” if the host is not present. [Table 5](#) summarizes the faults that are detected and the resulting behavior.

Table 5. Fault Condition

Fault Condition	Charger Behavior	Safety Timer Behavior
Input OVP	ICHG Disabled	Suspended
Input UVLO	ICHG Disabled	Reset
Sleep (VIN < VBAT)	ICHG Disabled	Suspended
TS Fault (Batter Over Temp)	ICHG Disabled	Suspended
Thermal Shutdown	ICHG Disabled	Suspended
Timer Fault	ICHG Disabled	Reset
No Battery	ICHG Disabled	Suspended
ISET Short	ICHG Disabled	Suspended
Input Fault and LDO Low	ICHG Disabled	Suspended

10.3.9 Watchdog Timer

In addition to the safety timer, the bq24257 contains a 50-second watchdog timer that monitors the host through the I²C interface. Once a write is performed on the I²C interface, a watchdog timer is reset and started. The watchdog timer can be disabled by writing “0” on WD_EN bit of register #1. Writing “1” on that bit enables it and reset the timer.

If the watchdog timer expires, the IC enters DEFAULT mode where the default charge parameters are loaded and charging continues. The I²C may be accessed again to re-initialize the desired values and restart the watchdog timer as long as the safety timer has not expired. Once the safety timer expires, charging is disabled.

10.3.10 Thermal Regulation and Thermal Shutdown

During the charging process, to prevent overheat of the chip, bq2425x monitors the junction temperature, T_J , of the die and begins to taper down the charge current once T_J reaches the thermal regulation threshold, TREG. The charge current is reduced when the junction temperature increases about above T_{REG} . Once the charge current is reduced, the system current is reduced while the battery supplements the load to supply the system. This may cause a thermal shutdown of the IC if the die temperature rises too. At any state, if T_J exceeds T_{SHTDWN} , bq2425x suspends charging and disables the buck converter. During thermal shutdown mode, PWM is turned off, all timers are suspended, and a single 256 μ s pulse is sent on the STAT output and the FAULT/STAT bits of the status registers are updated in the I²C. A new charging cycle begins when T_J falls below TSHTDWN by approximately 10°C.

10.4 Device Functional Modes

The bq24257 family provides a switch-mode buck regulator with output non-power path and a charge controller to provide optimum performance over the full battery charge cycle. The control loop for the buck regulator has 6 primary feedback loops that can set the duty cycle:

1. Constant Current (CC)
2. Constant Voltage (CV)
3. Input Current (I_{LIM})
4. Input Voltage (V_{IN_DPM})
5. Die Temperature
6. Cycle by Cycle Current

The feedback with the minimum duty cycle is chosen as the active loop. The bq24257 supports a precision Li-Ion or Li-Polymer charging system for single-cell applications. The bq24257 includes an integrated charge sense resistor for highly accurate charge current sensing while reducing the external BOM requirements. Figure 21 below illustrates a typical charge profile.

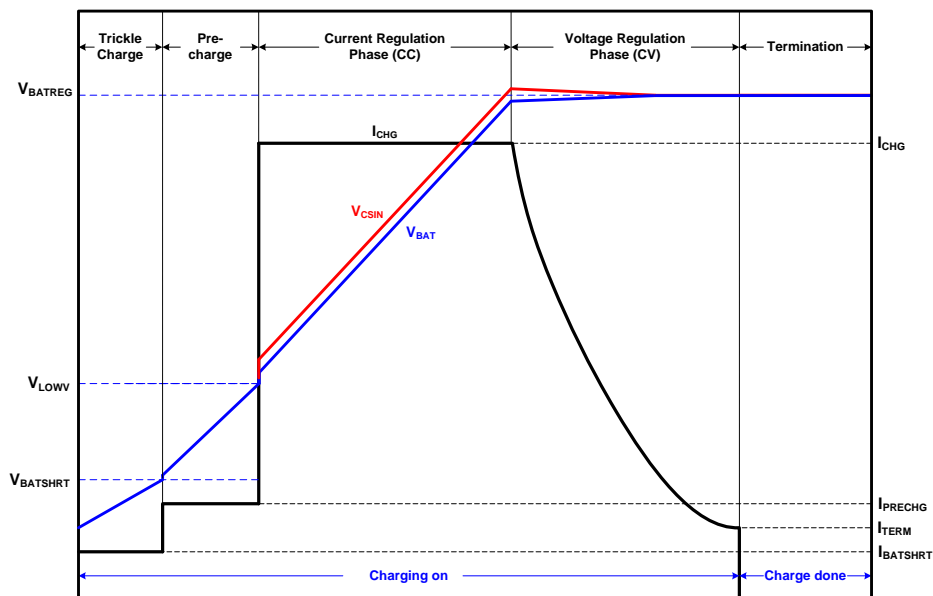

Figure 21. Li-ion Battery Charge Profile

The bq24258 supports an advanced Lithium-Iron-Phosphate (LiFePO_4) algorithm. This allows for the charger to source the charge current up to the $V_{REG-OVCHG}$ level before entering the float charge region. See Figure 22 below for the charge profile characteristics:

Device Functional Modes (continued)

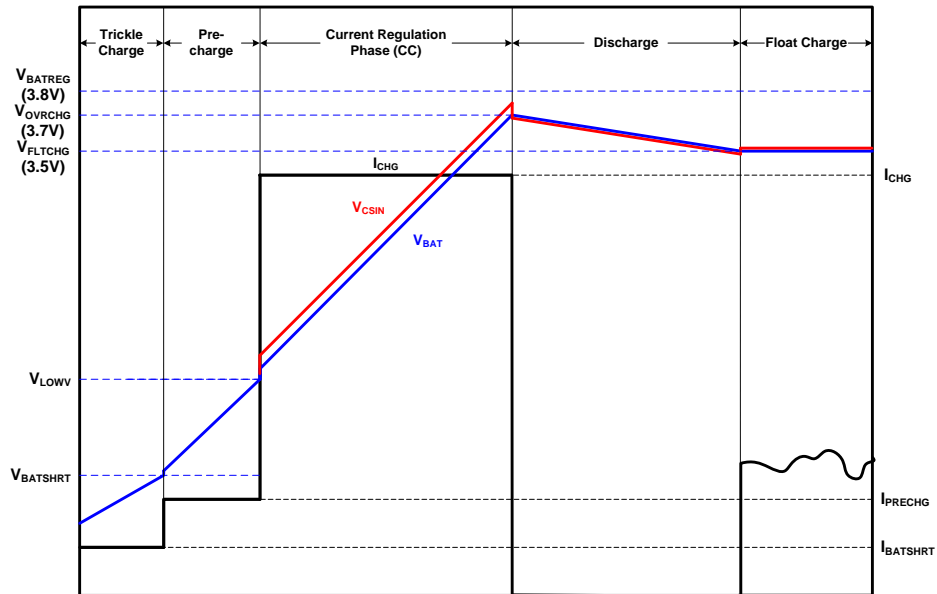

Figure 22. LiFePO4 Battery Charge Profile

10.5 Register Maps

Register #1

Memory location: 00, Reset state: x0xx xxxx

BIT	NAME	Read/Write	FUNCTION
B7(MSB)	WD_FAULT	Read only	Read: 0 – No fault 1 – WD timeout if WD enabled
B6	WD_EN	Read/Write	0 – Disable 1 – Enable (also resets WC timer)
B5	STAT_1	Read only	00 – Ready
B4	STAT_0	Read only	01 – Charge in progress 10 – Charge done 11 – Fault
B3	FAULT_3	Read only	0000 – Normal
B2	FAULT_2	Read only	0001 – Input OVP
B1	FAULT_1	Read only	0010 – Input UVLO 0011 – Sleep
B0(LSB)	FAULT_0	Read only	0100 – Battery Temperature (TS) Fault 0101 – Battery OVP 0110 – Thermal Shutdown 0111 – Timer Fault 1000 – No Battery connected 1001 – ISET short 1010 – Input Fault & LDO Low

- **WD_FAULT** – ‘0’ indicates no watch dog fault has occurred, where a ‘1’ indicates a fault has previously occurred.
- **WD_EN** – Enables or disables the internal watch dog timer. A ‘1’ enables the watch dog timer and a ‘0’ disables it.
- **STAT** – Indicates the charge controller status
- **FAULT** – Indicates the faults that have occurred. If multiple faults occurred, they can be read by sequentially addressing this register (e.g. reading the register 2 or more times). Once all faults have been read and the device is in a non-fault state, the fault register will show “Normal”. Regarding the "Input Fault & LDO Low", the IC will indicate this fault if the LDO is low and at the same time the input is below UVLO or coming out of UVLO with LDO still low.

Register #2

Memory location: 01, Reset state: 1010 1100

BIT	NAME	Read/Write	FUNCTION
B7(MSB)	Reset	Write only	Write: 1 – Reset all registers to default values 0 – No effect
B6	I _{IN_LIMIT_2}	Read/Write	000 – USB2.0 host with 100mA current limit
B5	I _{IN_LIMIT_1}	Read/Write	001 – USB3.0 host with 150mA current limit
B4	I _{IN_LIMIT_0}	Read/Write	010 – USB2.0 host with 500mA current limit
			011 – USB3.0 host with 900mA current limit
			100 – Charger with 1500mA current limit
			101 – Charger with 2000mA current limit
			110 – External ILIM current limit(5)
B3	EN_STAT	Read/Write	111- No input current limit with internal clamp at 3A (PTM MODE)
B3	EN_STAT	Read/Write	0 – Disable STAT function 1 – Enable STAT function
B2	EN_TERM	Read/Write	0 – Disable charge termination 1 – Enable charge termination
B1	\overline{CE}	Read/Write	0 – Charging is enabled 1 – Charging is disabled
B0(LSB)	HZ_MODE	Read/Write	0 – Not high impedance mode 1 – High impedance mode

- **I_{IN_LIMIT}** – Sets the input current limit level. When in host mode this register sets the regulation level. However, when in standalone mode (e.g. no I²C writes have occurred after power up or the WD timer has expired) the external resistor setting for IILIM sets the regulation level.
- **EN_STAT** – Enables and disables the STAT pin. When set to a ‘1’ the STAT pin is enabled and function normally. When set to a ‘0’ the STAT pin is disabled and the open drain FET is in HiZ mode.
- **EN_TERM** – Enables and disables the termination function in the charge controller. When set to a ‘1’ the termination function will be enabled. When set to a ‘0’ the termination function will be disabled. When termination is disabled, there are no indications of the charger terminating (i.e. STAT pin or STAT registers).
- **\overline{CE}** – The charge enable bit which enables or disables the charge function. When set to a ‘0’, the charger operates normally. When set to a ‘1’, the charger is disabled.
- **HZ_MODE** – Sets the charger IC into low power standby mode. When set to a ‘1’, the switch mode controller is disabled. When set to a ‘0’, the charger operates normally.

Register #3

Memory location: 02, Reset state: 1000 1111

BIT	NAME	Read/Write	FUNCTION
B7(MSB)	V _{BATREG_5} ⁽¹⁾	Read/Write	Battery Regulation Voltage: 640mV (default 1)
B6	V _{BATREG_4} ⁽¹⁾	Read/Write	Battery Regulation Voltage: 320mV (default 0)
B5	V _{BATREG_3} ⁽¹⁾	Read/Write	Battery Regulation Voltage: 160mV (default 0)
B4	V _{BATREG_2} ⁽¹⁾	Read/Write	Battery Regulation Voltage: 80mV (default 0)
B3	V _{BATREG_1} ⁽¹⁾	Read/Write	Battery Regulation Voltage: 40mV (default 1)
B2	V _{BATREG_0} ⁽¹⁾	Read/Write	Battery Regulation Voltage: 20mV (default 1)
B1 ⁽⁴⁾⁽⁵⁾	USB_DET_1/EN1	Read Only	Return USB detection result or pin EN1/EN0 status – 00 – DCP detected / EN1=0, EN0=0 01 – CDP detected / EN1=0, EN0=1 10 – SDP detected / EN1=1, EN0=0 11 – Apple/TT or non-standard adaptor detected/EN1=1, EN0=1
B0(LSB)	USB_DET_0/EN0	Read Only	

(1) Charge voltage range is 3.5V–4.44V with the offset of 3.5V and step of 20mV (default 4.2V)

- **V_{BATREG}** – Sets the battery regulation voltage
- **USB_DET/EN** – Provides status of the D+/D– detection results for spins that include the D+/D– pins or the state of EN1/EN2 for spins that include the EN1/EN2 pins.

Register #4

Memory location: 03, Reset state: 0000 0000

BIT	NAME	Read/Write	FUNCTION
B7(MSB)	I _{CHG_4} ^{(1) (2)}	Read/Write	Charge current 800mA – (default 0)
B6	I _{CHG_3} ^{(1) (2)}	Read/Write	Charge current: 400mA – (default 0)
B5	I _{CHG_2} ^{(1) (2)}	Read/Write	Charge current: 200mA – (default 0)
B4	I _{CHG_1} ^{(1) (2)}	Read/Write	Charge current: 100mA – (default 0)
B3	I _{CHG_0} ^{(1) (2)}	Read/Write	Charge current: 50mA – (default 0)
B2	I _{TERM_2} ⁽³⁾	Read/Write	Termination current sense threshold: 100mA (default 0)
B1	I _{TERM_1} ⁽³⁾	Read/Write	Termination current sense threshold: 50mA (default 0)
B0(LSB)	I _{TERM_0} ⁽³⁾	Read/Write	Termination current sense threshold: 25mA (default 0)

(1) Charge current offset is 500mA and default charge current is 500mA (maximum is 2.0A)

(2) When all bits are 1's, it is external ISET charging mode

(3) Termination threshold voltage offset is 50mA. The default termination current is 50mA if ICHG is selected from I²C. Otherwise, termination is set to 10% in external I_{set} mode with +/-10% accuracy.

- **I_{CHG}** – Sets the charge current regulation
- **I_{TERM}** – Sets the current level at which the charger will terminate

Register #5

Memory location: 04, Reset state: xx00 x010

BIT	NAME	Read/Write	FUNCTION
B7(MSB)	LOOP_STATUS1 ⁽¹⁾	Read Only	00 – No loop is active that slows down timer 01 – V _{IN-DPM} regulation loop is active 10 – Input current limit loop is active 11 – Thermal regulation loop is active
B6	LOOP_STATUS0 ⁽¹⁾	Read Only	
B5	LOW_CHG	Read/Write	0 – Normal charge current set by 03h 1 – Low charge current setting 330mA (default 0)
B4	DPDM_EN	Read/Write	0 – Bit returns to 0 after D+/D– detection is performed 1 – Force D+/D– detection (default 0)
B3	CE_STATUS	Read Only	0 – CE low 1 – CE high
B2	VINDPM_2 ⁽²⁾	Read/Write	Input V _{IN-DPM} voltage: 320mV (default 0)
B1	VINDPM_1 ⁽²⁾	Read/Write	Input V _{IN-DPM} voltage: 160mV (default 1)
B0(LSB)	VINDPM_0 ⁽²⁾	Read/Write	Input V _{IN-DPM} voltage: 80mV (default 0)

(1) LOOP_STATUS bits show if there are any loop is active that slow down the safety timer. If a status occurs, these bits announce the status and do not clear until read. If more than one occurs, the first one is shown

(2) VIN-DPM voltage offset is 4.20V and default V_{IN-DPM} threshold is 4.36V.

- **LOOP_STATUS** – Provides the status of the active regulation loop. The charge controller allows for only one loop to regulate current at a time.
- **LOW_CHG** – When set to a '1', the charge current is reduced 330mA independent of the charge current setting in register 0x03. When set to '0', the charge current is set by register 0x03.
- **DPDM_EN** – Forces a D+/D– detection routine to be executed once a '1' is written. This is independent of the input being supplied.
- **CE_STATUS** – Provides the status of the \overline{CE} pin level. If the \overline{CE} pin is forced high, this bit returns a '1'. If the \overline{CE} pin is forced low, this bit returns a '0'.

Register #6

Memory location: 05, Reset state: 101x 1xxx

BIT	NAME	Read/Write	FUNCTION
B7(MSB)	2XTMR_EN	Read/Write	0 – Timer not slowed at any time 1 – Timer slowed by 2x when in thermal regulation, VIN_DPM or DPPM (default 1)
B6	TMR_1	Read/Write	Safety Timer Time Limit
B5	TMR_2	Read/Write	00 – 0.75 hour fast charge 01 – 6 hour fast charge (Default 01) 10 – 9 hour fast charge 11 – Disable safety timers
B4	SYSOFF	Read/Write	0 – SYSOFF disabled 1 – SYSOFF enabled
B2	TS_STAT2	Read only	TS Fault Mode:
B1	TS_STAT1	Read only	000 – Normal, No TS fault
B0(LSB)	TS_STAT0	Read only	100 – TS temp < T _{COLD} (Charging suspended for JEITA and Standard TS) 101 – T _{FREEZE} < TS temp < T _{COLD} (Charging at 3.9V and 100mA and only for PSE option only) 110 – TS temp < T _{FREEZE} (Charging suspended for PSE option only) 111 – TS open (TS disabled)

- **2xTMR_EN** – When set to a ‘0’, the 2x Timer function is enabled and allows for the timer to be extended if a condition occurs where the charge current is reduced (that is, VIN_DPM, thermal regulation, and so on). When set to a ‘1’, this function is disabled and the normal timer will always be executed independent of the current reduce conditions.
- **SYSOFF** – When set to a ‘1’ and the input is removed, the leakage from the BAT pin will be changed to less than 1µA. Note that this disconnects the battery from the IC. When set to a ‘0’, this function is disabled.
- **TS_EN** – Enables and disables the TS function. When set to a ‘1’ the TS function is disabled otherwise it is enabled. Only applies to spins that have a TS pin.
- **TS_STAT** – Provides status of the TS pin state for spins that have a TS pin.

Register #7

Memory location: 06, Reset state: 1110 0000 for the bq24258 and 0010 0000 for the bq24257.

BIT	NAME	Read/Write	FUNCTION
B7(MSB)	V _{OVP_2}	Read/Write	OVP voltage: 000 – 6.0V; 001 – 6.5V; 010 – 7.0V; 011 – 8.0V 100 – 9.0V; 101 – 9.5V; 110 – 10.0V; 111 – 10.5V
B6	V _{OVP_1}	Read/Write	
B5	V _{OVP_0}	Read/Write	
B4	CLR_VDP	Read/Write	0 – Keep D+ voltage source on during DBP charging 1 – Turn off D+ voltage source to release D+ line
B3	FORCE_BATDET	Read/Write	0 – Enter the battery detection routine only if TERM is true or EN_PTM is true 1 – Enter the battery detection routine
B2	FORCE_PTM	Read/Write	0 – PTM mode is disabled 1 – PTM mode is enabled if OTP_EN_PTM=1
B1	N/A	Read/Write	
B0(LSB)	N/A	Read/Write	

- **V_{OVP}** – Sets the OVP level
- **CLR_VDP** – When the D+/D– detection has finished, some cases require the D+ pin to force a voltage of 0.6V. This bit allows the system to clear the voltage prior to any communication on the D+/D– pins. A ‘1’ clears the voltage at the D+ pin if present.
- **FORCE_BATDET** – Forces battery detection and provides status of the battery presence. A logic ‘1’ enables this function.
- **FORCE_PTM** – Puts the device in production test mode (PTM) where the input current limit is disabled. Note that a battery must not be present prior to using this function. Otherwise the function will not be allowed to execute. A logic ‘1’ enables the PTM function.

11 Application and Implementation

NOTE

Information in the following applications sections is not part of the TI component specification, and TI does not warrant its accuracy or completeness. TI's customers are responsible for determining suitability of components for their purposes. Customers should validate and test their design implementation to confirm system functionality.

11.1 Application Information

The bq24257EVM-150 evaluation module (EVM) is a complete charger module for evaluating the bq24257.

11.2 Typical Application

Bq24257 and bq24258 devices are highly-integrated, single cell, Li-Ion battery chargers with integrated current sense resistors targeted for space-limited, portable applications with high-capacity batteries. They are featured with a high-efficiency switch-mode charger. They have integrated power FETs able to charge at up to a 2-A charging rate, and an integrated 50-mA LDO. In I²C mode, the bq24257 device has programmable battery charge voltage (VBATREG), charge current (ICHG), input current limit (ILIM), and input over-voltage protection threshold (VOVP).

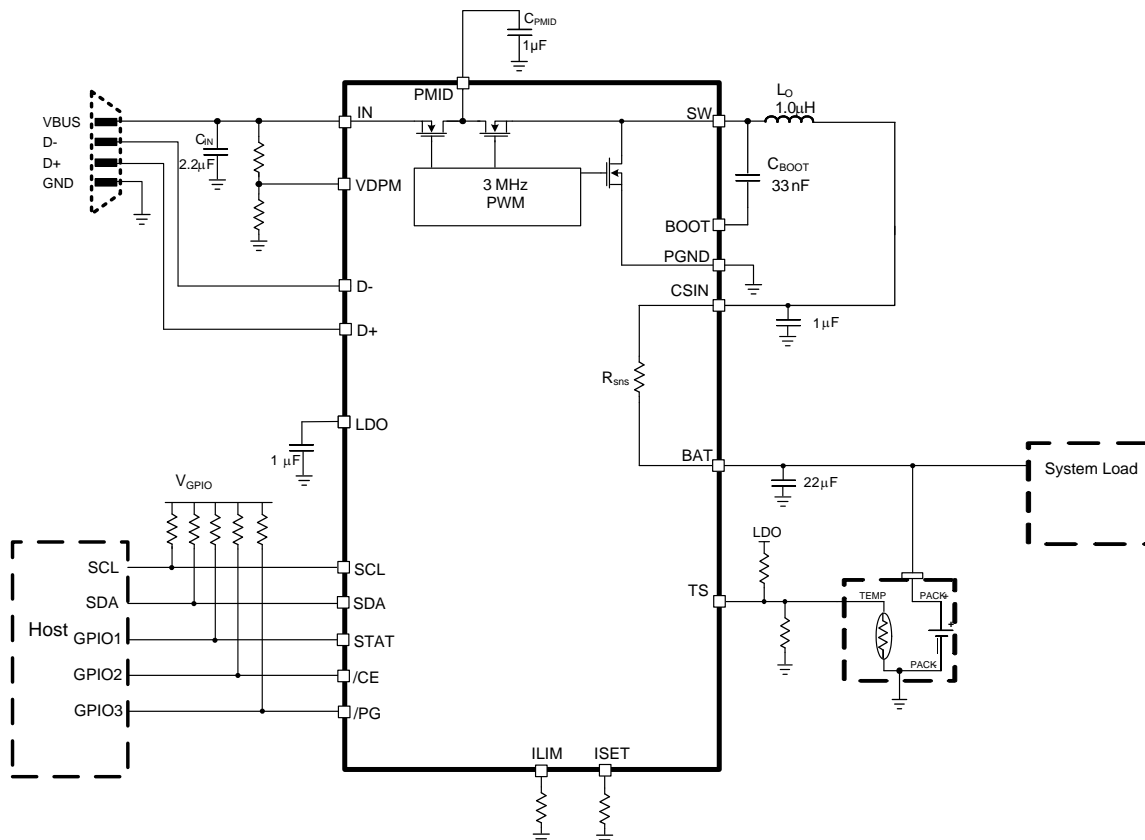

Figure 23. bq24257 Typical Application Circuit

Typical Application (continued)

11.2.1 Design Requirements

Use the following typical application design procedure to select external components values for the bq24257 device.

Table 6. Design Parameters

SPECIFICATION	TEST CONDITION	MIN	TYP	MAX	UNIT
Input DC voltage, VIN	Recommended input voltage range	4.35		10.5	V
Input current	Recommended input current range			2	A
Charge current	Fast charge current range	0.5		2	A
Output regulation voltage	Standalone mode or I ² C default mode		4.2		V
Output regulation voltage	I ² C host mode: operating in voltage regulation, programmable range	3.5		4.44	V
LDO	LDO output voltage		4.9		V

11.2.2 Detailed Design Procedure

11.2.2.1 Components Selection

The inductor selection depends on the application requirements. The bq24257 and bq24258 are designed to operate at around 1 μ H. The value has an effect on efficiency, and the ripple requirements, stability of the charger, package size, and DCR of the inductor. The 1 μ H inductor provides a good tradeoff between size and efficiency and ripple.

Once the inductance has been selected, the peak current is needed in order to choose the saturation current rating of the inductor. Make sure that the saturation current is always greater than or equal to the calculated I_{PEAK} . The following equation can be used to calculate the current ripple:

$$\Delta I_L = \{VBAT (VIN - VBAT)\} / (VIN \times f_s \times L) \quad (6)$$

Then use current ripple to calculate the peak current as follows:

$$I_{PEAK} = Load \times (1 + \Delta I_L / 2) \quad (7)$$

In this design example, the regulation voltage is set to 4.2V, the input voltage is 5V and the inductance is selected to be 1 μ H. The maximum charge current that can be used in this application is 1A and can be set by I²C command. The peak current is needed in order to choose the saturation current rating of the inductor. Using equation 6 and 7, ΔI_L is calculated to be 0.224A and the inductor peak current is 1.112A. A 1 μ F CSIN cap is needed and 22 μ F BAT cap is needed on the output trace.

The default settings for external fast charge current and external setting of current limit are chosen to be IFC=500mA and ILIM=1A. RISET and RILIM need to be calculated using equation 1 and 2 in the data sheet.

The fast charge current resistor (RISET) can be set as follows:

$$RISET = 250 / 0.5A = 500\Omega$$

The input current limit resistor (RILIM) can be set as follows:

$$RILIM = 270 / 1A = 270\Omega$$

The external settings of VIN_DPM can be designed by calculating R1 and R2 according to equation 3 in this data sheet and the typical application circuit. VIN_DPM should be chosen first along with R1. VIN_DPM is chosen to be 4.48V and R1 is set to 274K Ω in this design example. Using equation 3, the value of R2 is calculated to be 100 k Ω .

In this design example, the application needs to be JEITA compliant. Thus, T_{COLD} must be 0°C and T_{HOT} must be 60°C. If an NTC resistor is chosen such that the beta is 4500K and the nominal resistance is 13K Ω , the calculated R3 and R4 values are 5K Ω and 8.8K Ω respectively. These results are obtained from equation 4 and 5 in this data sheet.

11.2.3 Application Curves

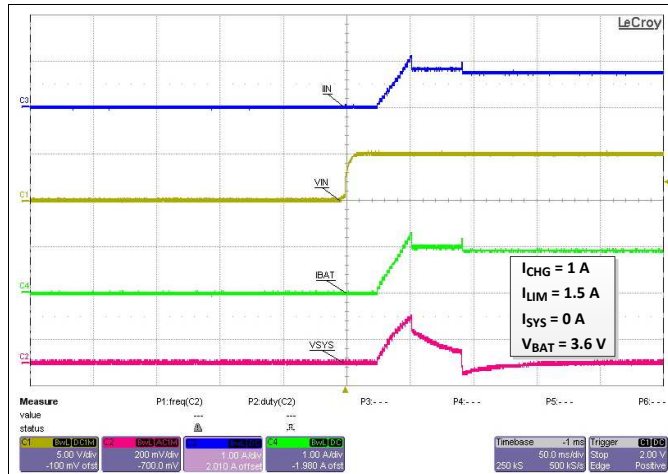

Figure 24. Startup

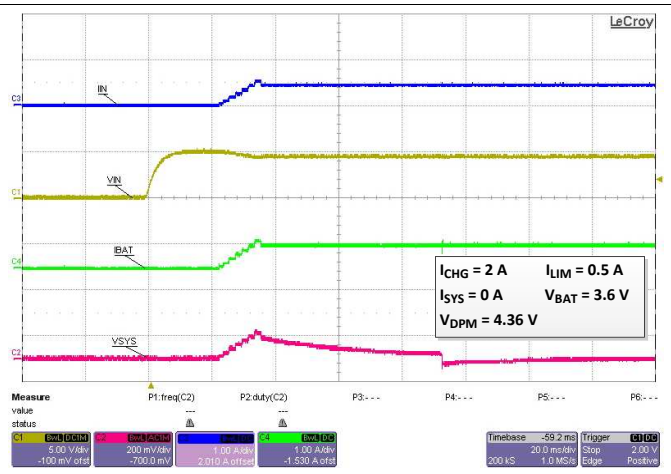

Figure 25. V_{DPM} Startup, 4.2 V

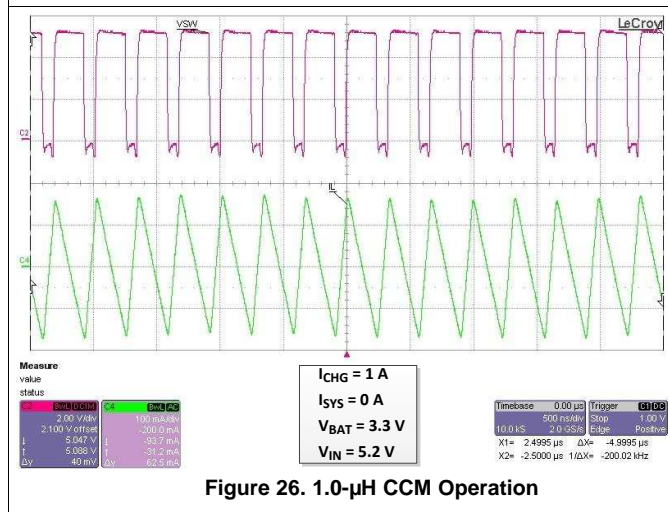

Figure 26. 1.0-µH CCM Operation

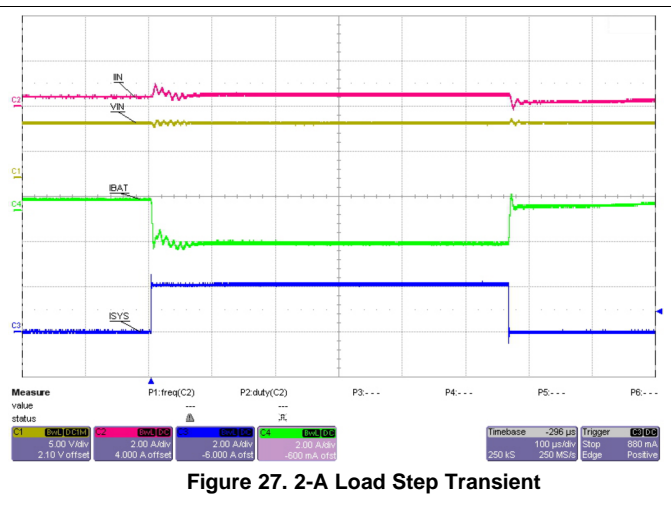

Figure 27. 2-A Load Step Transient

12 Power Supply Recommendations

The devices are designed to operate from an input voltage range between 4.35V and 10.5V. This input supply must be well regulated. If the input supply is located more than a few inches from the bq24257 charger, additional bulk capacitance may be required in addition to the ceramic bypass capacitors.

13 Layout

13.1 Layout Guidelines

1. Place the BOOT, PMID, IN, BAT, and LDO capacitors as close as possible to the IC for optimal performance.
2. Connect the inductor as close as possible to the SW pin, and the SYS/CSIN cap as close as possible to the inductor minimizing noise in the path.
3. Place a 1- μ F PMID capacitor as close as possible to the PMID and PGND pins, making the high frequency current loop area as small as possible.
4. The local bypass capacitor from SYS/CSIN to GND must be connected between the SYS/CSIN pin and PGND of the IC. This minimizes the current path loop area from the SW pin through the LC filter and back to the PGND pin.
5. Place all decoupling capacitors close to their respective IC pins and as close as possible to PGND (do not place components such that routing interrupts power-stage currents). All small control signals must be routed away from the high-current paths.
6. To reduce noise coupling, use a ground plane if possible, to isolate the noisy traces from spreading its noise all over the board. Put vias inside the PGND pads for the IC.
7. The high-current charge paths into IN, Micro-USB, BAT, SYS/CSIN, and from the SW pins must be sized appropriately for the maximum charge current to avoid voltage drops in these traces.
8. For high-current applications, the balls for the power paths must be connected to as much copper in the board as possible. This allows better thermal performance because the board conducts heat away from the IC.

13.2 Layout Example

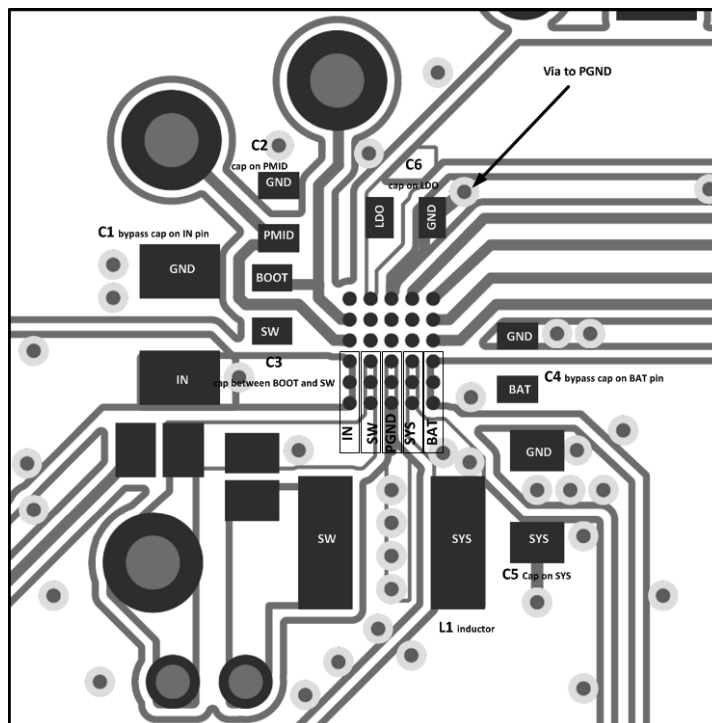

Figure 28. Recommended bq2425x PCB Layout for WCSP Package

13.3 Device and Documentation Support

13.3.1 Related Links

The table below lists quick access links. Categories include technical documents, support and community resources, tools and software, and quick access to sample or buy.

Table 7. Related Links

PARTS	PRODUCT FOLDER	SAMPLE & BUY	TECHNICAL DOCUMENTS	TOOLS & SOFTWARE	SUPPORT & COMMUNITY
bq24257	Click here	Click here	Click here	Click here	Click here
bq24258	Click here	Click here	Click here	Click here	Click here

14 Mechanical, Packaging, and Orderable Information

The following pages include mechanical, packaging, and orderable information. This information is the most current data available for the designated devices. This data is subject to change without notice and revision of this document. For browser-based versions of this data sheet, refer to the left-hand navigation.

PACKAGING INFORMATION

Orderable Device	Status (1)	Package Type	Package Drawing	Pins	Package Qty	Eco Plan (2)	Lead finish/ Ball material (6)	MSL Peak Temp (3)	Op Temp (°C)	Device Marking (4/5)	Samples
BQ24257RGER	NRND	VQFN	RGE	24	3000	RoHS & Green	NIPDAU	Level-2-260C-1 YEAR	-40 to 85	BQ24257	
BQ24257RGET	NRND	VQFN	RGE	24	250	RoHS & Green	NIPDAU	Level-2-260C-1 YEAR	-40 to 85	BQ24257	
BQ24257YFFR	NRND	DSBGA	YFF	30	3000	RoHS & Green	SNAGCU	Level-1-260C-UNLIM	-40 to 85	BQ24257	
BQ24257YFFT	NRND	DSBGA	YFF	30	250	RoHS & Green	SNAGCU	Level-1-260C-UNLIM	-40 to 85	BQ24257	

(1) The marketing status values are defined as follows:

ACTIVE: Product device recommended for new designs.

LIFEBUY: TI has announced that the device will be discontinued, and a lifetime-buy period is in effect.

NRND: Not recommended for new designs. Device is in production to support existing customers, but TI does not recommend using this part in a new design.

PREVIEW: Device has been announced but is not in production. Samples may or may not be available.

OBSOLETE: TI has discontinued the production of the device.

(2) **RoHS:** TI defines "RoHS" to mean semiconductor products that are compliant with the current EU RoHS requirements for all 10 RoHS substances, including the requirement that RoHS substance do not exceed 0.1% by weight in homogeneous materials. Where designed to be soldered at high temperatures, "RoHS" products are suitable for use in specified lead-free processes. TI may reference these types of products as "Pb-Free".

RoHS Exempt: TI defines "RoHS Exempt" to mean products that contain lead but are compliant with EU RoHS pursuant to a specific EU RoHS exemption.

Green: TI defines "Green" to mean the content of Chlorine (Cl) and Bromine (Br) based flame retardants meet JS709B low halogen requirements of <=1000ppm threshold. Antimony trioxide based flame retardants must also meet the <=1000ppm threshold requirement.

(3) MSL, Peak Temp. - The Moisture Sensitivity Level rating according to the JEDEC industry standard classifications, and peak solder temperature.

(4) There may be additional marking, which relates to the logo, the lot trace code information, or the environmental category on the device.

(5) Multiple Device Markings will be inside parentheses. Only one Device Marking contained in parentheses and separated by a "~" will appear on a device. If a line is indented then it is a continuation of the previous line and the two combined represent the entire Device Marking for that device.

(6) Lead finish/Ball material - Orderable Devices may have multiple material finish options. Finish options are separated by a vertical ruled line. Lead finish/Ball material values may wrap to two lines if the finish value exceeds the maximum column width.

Important Information and Disclaimer:The information provided on this page represents TI's knowledge and belief as of the date that it is provided. TI bases its knowledge and belief on information provided by third parties, and makes no representation or warranty as to the accuracy of such information. Efforts are underway to better integrate information from third parties. TI has taken and continues to take reasonable steps to provide representative and accurate information but may not have conducted destructive testing or chemical analysis on incoming materials and chemicals. TI and TI suppliers consider certain information to be proprietary, and thus CAS numbers and other limited information may not be available for release.

In no event shall TI's liability arising out of such information exceed the total purchase price of the TI part(s) at issue in this document sold by TI to Customer on an annual basis.

TAPE AND REEL INFORMATION

QUADRANT ASSIGNMENTS FOR PIN 1 ORIENTATION IN TAPE

*All dimensions are nominal

Device	Package Type	Package Drawing	Pins	SPQ	Reel Diameter (mm)	Reel Width W1 (mm)	A0 (mm)	B0 (mm)	K0 (mm)	P1 (mm)	W (mm)	Pin1 Quadrant
BQ24257RGER	VQFN	RGE	24	3000	330.0	12.4	4.25	4.25	1.15	8.0	12.0	Q2
BQ24257RGET	VQFN	RGE	24	250	180.0	12.4	4.25	4.25	1.15	8.0	12.0	Q2
BQ24257YFFR	DSBGA	YFF	30	3000	180.0	8.4	2.09	2.59	0.78	4.0	8.0	Q1
BQ24257YFFT	DSBGA	YFF	30	250	180.0	8.4	2.09	2.59	0.78	4.0	8.0	Q1

TAPE AND REEL BOX DIMENSIONS

*All dimensions are nominal

Device	Package Type	Package Drawing	Pins	SPQ	Length (mm)	Width (mm)	Height (mm)
BQ24257RGER	VQFN	RGE	24	3000	367.0	367.0	35.0
BQ24257RGET	VQFN	RGE	24	250	210.0	185.0	35.0
BQ24257YFFR	DSBGA	YFF	30	3000	182.0	182.0	20.0
BQ24257YFFT	DSBGA	YFF	30	250	182.0	182.0	20.0

EXAMPLE BOARD LAYOUT

YFF0030

DSBGA - 0.625 mm max height

DIE SIZE BALL GRID ARRAY

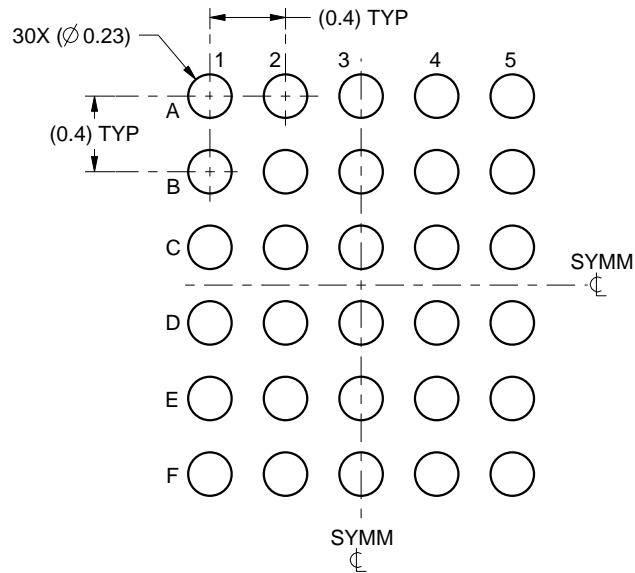

LAND PATTERN EXAMPLE
SCALE:25X

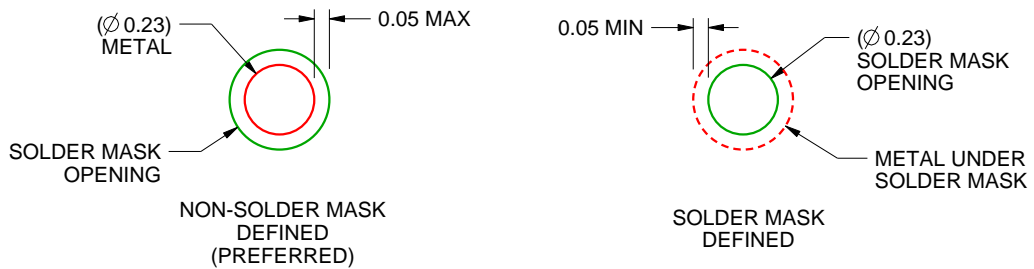

SOLDER MASK DETAILS
NOT TO SCALE

4219433/A 03/2016

NOTES: (continued)

3. Final dimensions may vary due to manufacturing tolerance considerations and also routing constraints. For more information, see Texas Instruments literature number SNVA009 (www.ti.com/lit/snva009).

EXAMPLE STENCIL DESIGN

YFF0030

DSBGA - 0.625 mm max height

DIE SIZE BALL GRID ARRAY

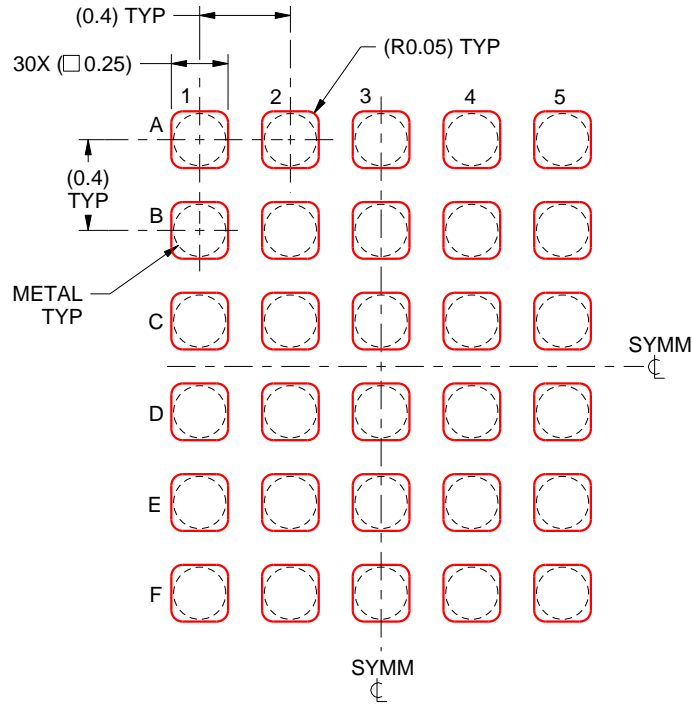

SOLDER PASTE EXAMPLE
BASED ON 0.1 mm THICK STENCIL
SCALE:30X

4219433/A 03/2016

NOTES: (continued)

4. Laser cutting apertures with trapezoidal walls and rounded corners may offer better paste release.

RGE 24

GENERIC PACKAGE VIEW

VQFN - 1 mm max height

PLASTIC QUAD FLATPACK - NO LEAD



Images above are just a representation of the package family, actual package may vary.
Refer to the product data sheet for package details.

4204104/H

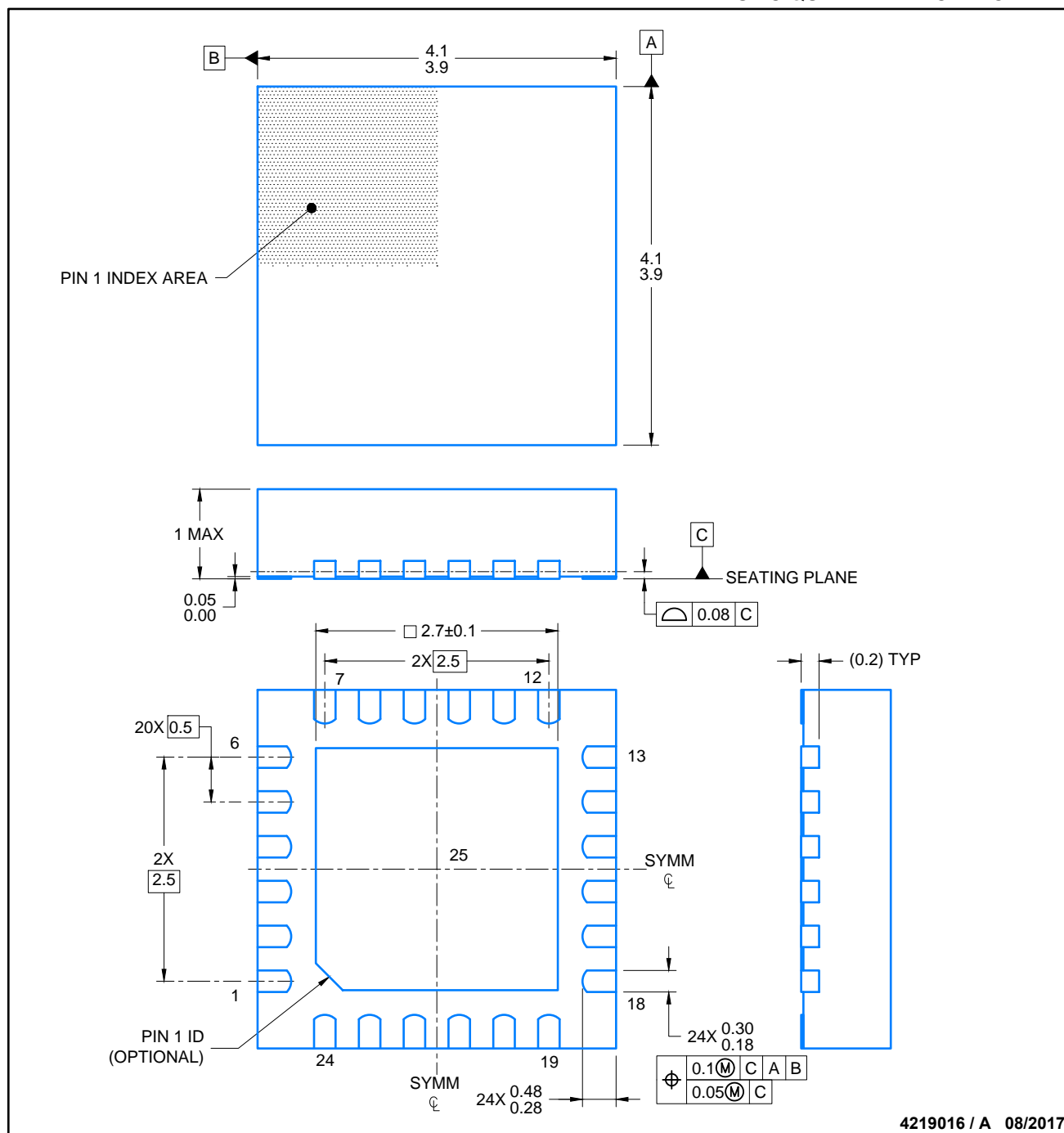

NOTES:

1. All linear dimensions are in millimeters. Any dimensions in parenthesis are for reference only. Dimensioning and tolerancing per ASME Y14.5M.
2. This drawing is subject to change without notice.
3. The package thermal pad must be soldered to the printed circuit board for thermal and mechanical performance.

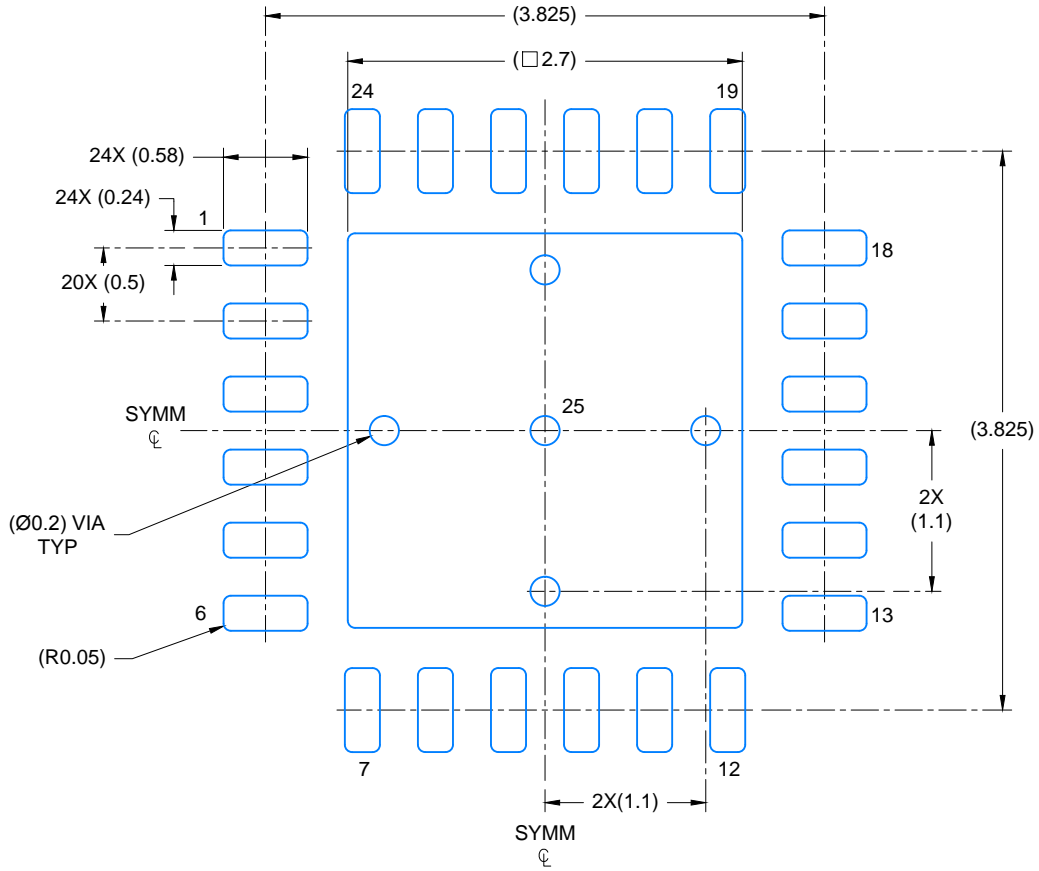

LAND PATTERN EXAMPLE
SCALE: 20X

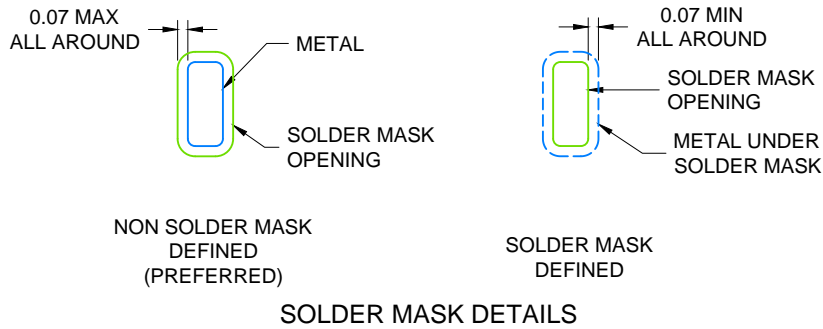

4219016 / A 08/2017

NOTES: (continued)

4. This package is designed to be soldered to a thermal pad on the board. For more information, see Texas Instruments literature number SLUA271 (www.ti.com/lit/slua271).
5. Solder mask tolerances between and around signal pads can vary based on board fabrication site.

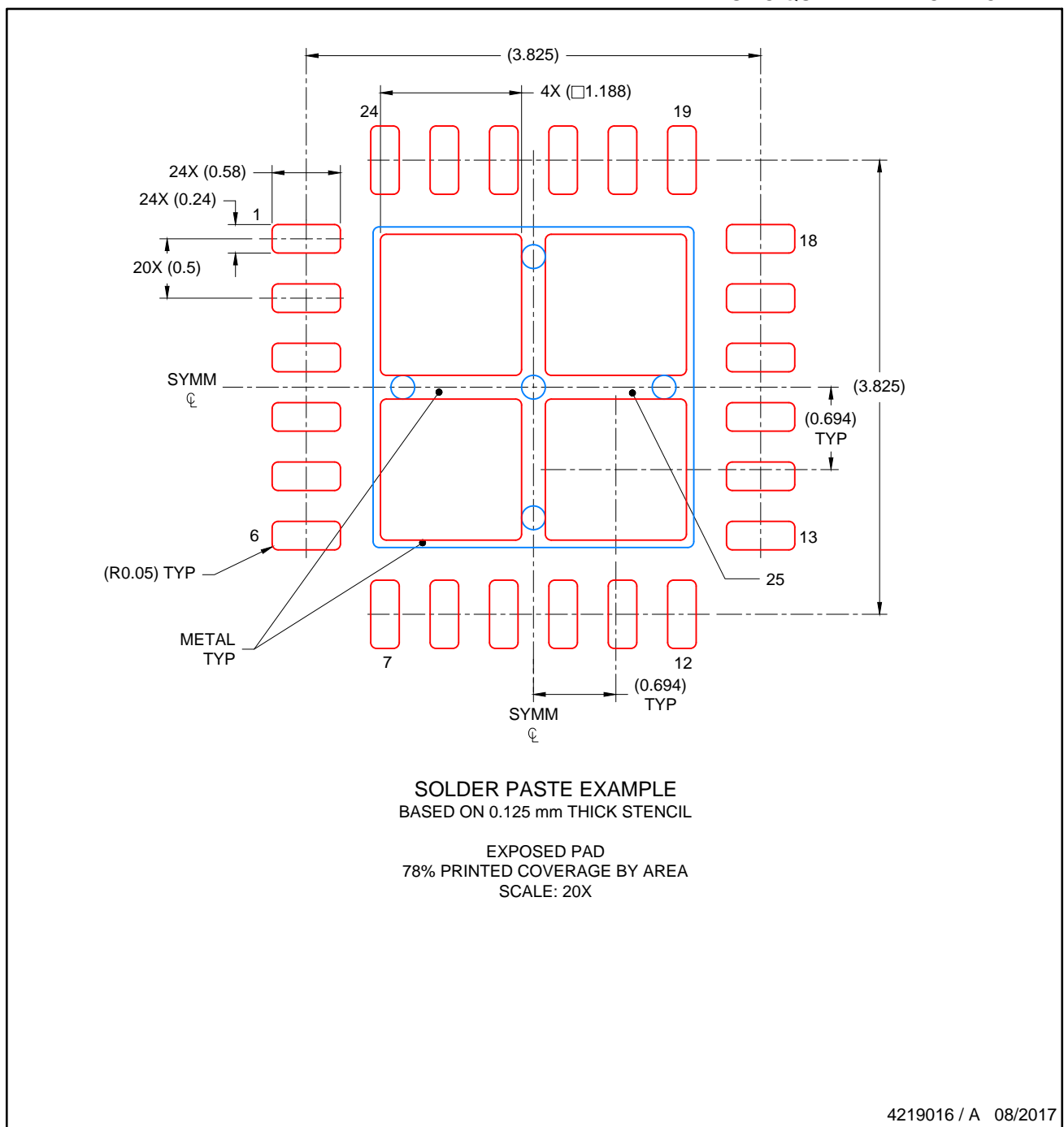

NOTES: (continued)

- 6. Laser cutting apertures with trapezoidal walls and rounded corners may offer better paste release. IPC-7525 may have alternate design recommendations..

IMPORTANT NOTICE AND DISCLAIMER

TI PROVIDES TECHNICAL AND RELIABILITY DATA (INCLUDING DATASHEETS), DESIGN RESOURCES (INCLUDING REFERENCE DESIGNS), APPLICATION OR OTHER DESIGN ADVICE, WEB TOOLS, SAFETY INFORMATION, AND OTHER RESOURCES "AS IS" AND WITH ALL FAULTS, AND DISCLAIMS ALL WARRANTIES, EXPRESS AND IMPLIED, INCLUDING WITHOUT LIMITATION ANY IMPLIED WARRANTIES OF MERCHANTABILITY, FITNESS FOR A PARTICULAR PURPOSE OR NON-INFRINGEMENT OF THIRD PARTY INTELLECTUAL PROPERTY RIGHTS.

These resources are intended for skilled developers designing with TI products. You are solely responsible for (1) selecting the appropriate TI products for your application, (2) designing, validating and testing your application, and (3) ensuring your application meets applicable standards, and any other safety, security, or other requirements. These resources are subject to change without notice. TI grants you permission to use these resources only for development of an application that uses the TI products described in the resource. Other reproduction and display of these resources is prohibited. No license is granted to any other TI intellectual property right or to any third party intellectual property right. TI disclaims responsibility for, and you will fully indemnify TI and its representatives against, any claims, damages, costs, losses, and liabilities arising out of your use of these resources.

TI's products are provided subject to TI's Terms of Sale (www.ti.com/legal/termsofsale.html) or other applicable terms available either on ti.com or provided in conjunction with such TI products. TI's provision of these resources does not expand or otherwise alter TI's applicable warranties or warranty disclaimers for TI products.

Mailing Address: Texas Instruments, Post Office Box 655303, Dallas, Texas 75265
Copyright © 2020, Texas Instruments Incorporated