

Item description

Male connector/plug *WINSTA*® MINI A coding

The *WINSTA*® MINI male connector/plug A coding allows installation of solid and fine-stranded conductors. On PCBs, in control cabinets or for connecting lights – pluggable installation connectors from WAGO allow you to establish connections according to an enormous variety of requirements in next to no time. For greater security in electrical installations, the pluggable installation connector is provided with mechanical protection against mismatching. The pluggable installation connector is protected against ingress by solid granular objects with a diameter of less than 1 mm in accordance with protection type IP40. General mains applications for almost any domain of use can be realised with *WINSTA*® MINI pluggable installation connectors with A coding. Thanks to its particularly minimal dimensions, our *WINSTA*® MINI Pluggable Connection System with Push-in CAGE CLAMP® spring pressure connection technology is specifically suitable in very restricted spaces, i.e., for connections when very little room is available. A range up to 40 mm can be used for the strip length.

Subject to changes. Please also observe the further product documentation!



Push-in CAGE CLAMP® spring pressure connection technology – pluggable installation instead of laborious screw connections!

The WINSTA® Pluggable Connection System is perfectly tailored to the strict requirements of building installation. It makes electrical installation pluggable, and consequently more efficient, even more reliable, and error-free. Using this pre-assembled system reduces assembly times and errors during installation at the construction site. Choose quality and durability – the WINSTA® MINI pluggable installation connector with marking from WAGO makes the electrical installation of electrical components noticeably easier.

- protection against mismatching eliminates errors
- easy tool-free operation, a wide range of coding options
- for any mains application
- ready for immediate use
- convenient installation and commissioning

Data

Electrical data

Ratings per IEC/EN

Ratings per	IEC/EN 60664-1
Nominal voltage (III/3)	250 V
Rated impulse voltage (III/3)	4 kV
Rated current	16 A
Legend (ratings)	(III / 3) ≙ Overvoltage category III / Pollution degree 3

Ratings per UL 1977

Note for the US market	Some versions may also be used for current interruption in accordance with the UL certificate in select applications with currents below 5 A and voltages up to 600 V. For further information, please contact your local sales office.
Rated voltage (UL 1977)	600 V
Rated current UL 1977	14 A

General

Note on contact resistance	approx. 1 mΩ of contact resistance approx. 0.25 mΩ contact transition plug/socket
----------------------------	--

Subject to changes. Please also observe the further product documentation!



Connection data

Connection points	3
Total number of potentials	3
PE function	Preceding PE contact

Connection 1

Connection technology	Push-in CAGE CLAMP®
Actuation type	Operating tool Push-in
Nominal cross-section	1.5 mm ² / 16 AWG
Solid conductor	0.25 ... 1.5 mm ² / 22 ... 16 AWG
Solid conductor; push-in termination	0.75 ... 1.5 mm ² / 20 ... 16 AWG
Stranded conductor	0.25 ... 1 mm ² / 22 ... 18 AWG
Fine-stranded conductor	0.25 ... 1.5 mm ² / 22 ... 16 AWG
Fine-stranded conductor; with insulated ferrule	0.25 ... 0.75 mm ² / 22 ... 20 AWG
Fine-stranded conductor; with uninsulated ferrule	0.25 ... 0.75 mm ² / 22 ... 20 AWG
Fine-stranded conductor; with ferrule; push-in termination	0.75 mm ² / 20 AWG
Strip length	9 mm / 0.35 inches
Pole number	3
Conductor entry direction to mating direction	0°
Strip length (outer insulation)	40 mm

Physical data

Pin spacing	4.4 mm / 0.173 inches
Width	17.9 mm / 0.705 inches
Height	14 mm / 0.551 inches
Depth	63.6 mm / 2.504 inches

Mechanical Data

Application	General mains applications
Coding	A
Variable coding	No
Marking	N \perp L
Potential marking	N \perp L
Mating force of a plug-in connection	approx. 20 ... 70 N (depending on pole number)
Retention force of a plug-in connection	Locked: > 80 N

Subject to changes. Please also observe the further product documentation!



Unmating force of a plug-in connection	Unlocked: approx. 20 ... 70 N (depending on pole number)
Number of mating cycles	200, without resistive load
Protection type	IP40

Plug-in connection

Contact type (pluggable connector)	Male connector/plug
Connector (connection type)	for conductor
Mismating protection	Yes
Note on mismating protection	All <i>WINSTA</i> [®] components are 100% protected against mismating when: a.) plugging different numbers of poles b.) plugging while rotated 180 c.) plugging while laterally staggered d.) plugging one pole
Locking lever	Can be retrofitted
Locking of plug-in connection	locking lever
Note on locking system	All connectors for mounted installations (snap-in versions for lighting fixtures or devices, all types of PCB and distribution connectors) are factory-equipped with locking levers to ensure plugs and sockets are securely locked. Additional locking levers are only required for flying leads (plug/socket).
Strain relief	strain relief housing

Material Data

Note (material data)	Information on material specifications can be found here
Color	black
Cover color	gray
Material group	I
Insulation material	Polyamide (PA66)
Flammability class per UL94	V0
Clamping spring material	Chrome-nickel spring steel (CrNi)
Contact material	Copper or copper alloy; surface-treated
Contact plating	Tin
Fire load	0.23 MJ
Weight	8.5 g

Subject to changes. Please also observe the further product documentation!

Environmental requirements

Processing temperature	-5 ... +40 °C
Continuous operating temperature	-35 ... +85 °C
Note on continuous operating temperature	Insulating parts for temperatures ≤ 105 °C

Commercial data



Product Group	20 (Winsta)
eCl@ss 10.0	27-44-06-05
eCl@ss 9.0	27-44-06-05
ETIM 8.0	EC002560
ETIM 7.0	EC002560
PU (SPU)	50 pcs
Packaging type	box
Country of origin	DE
GTIN	4045454232900
Customs tariff number	85366990990

Environmental Product Compliance

RoHS Compliance Status	Compliant, No Exemption
------------------------	-------------------------

Approvals / Certificates

General approvals

Logo	Approval	Additional Approval Text	Certificate name
	CCA DEKRA Certification B.V.	EN 61535	71- 123231
	CCA DEKRA Certification B.V.	IEC 61535	NL-85020
	cURus Underwriters Laboratories Inc.	UL 1977	E45171

Declarations of conformity and manufacturer's declarations

Logo	Approval	Additional Approval Text	Certificate name
------	----------	--------------------------	------------------

Subject to changes. Please also observe the further product documentation!

WAGO GmbH & Co. KG
 Hansastr. 27
 32423 Minden
 Phone: +49571 887-0 | Fax: +49571 887-169
 Email: info.de@wago.com | Web: www.wago.com

Do you have any questions about our products?
 We are always happy to take your call at +49 (571) 887-44222.



EU-Declaration of Conformity
WAGO GmbH & Co. KG

-

-





UK-Declaration of Conformity
WAGO GmbH & Co. KG





-

-

Approvals for marine applications

Logo	Approval	Additional Approval Text	Certificate name
	ABS American Bureau of Shipping	Steel Vessel Rules	19- HG1869855- PDA
	DNV GL Det Norske Veritas, Germanischer Lloyd	-	TAE00001Z6
	LR Lloyds Register	EN 61535	08/20047 (E2)

Counterpart

	Item no.890-103 Socket; with strain relief housing; 3-pole; Cod. A; 1,50 mm ² ; black	www.wago.com/890-103
	Item no.890-203 Socket; 3-pole; Cod. A; 1,50 mm ² ; black	www.wago.com/890-203
	Item no.890-615 T-distribution connector; 3-pole; Cod. A; 1 input; 2 outputs; 3 locking levers; for flying leads; black	www.wago.com/890-615
	Item no.890-606 T-distribution connector; 3-pole; Cod. A; 1 input; 2 outputs; 2 locking levers; black	www.wago.com/890-606
	Item no.890-634 h-distribution connector; 3-pole; Cod. A; 1 input; 2 outputs; outputs on one side; 2 locking levers; black	www.wago.com/890-634
	Item no.890-636	

Subject to changes. Please also observe the further product documentation!

WAGO GmbH & Co. KG
Hansastr. 27
32423 Minden
Phone: +49571 887-0 | Fax: +49571 887-169
Email: info.de@wago.com | Web: www.wago.com

Do you have any questions about our products?
We are always happy to take your call at +49 (571) 887-44222.



h-distribution connector; 3-pole; Cod. A; 1 input; 2 outputs; outputs on one side; 3 locking levers; for flying leads; black www.wago.com/890-636



Item no.890-703
Snap-in socket; 3-pole; Cod. A; 1,50 mm²; black www.wago.com/890-703



Item no.890-803
Socket for PCBs; straight; 3-pole; Cod. A; black www.wago.com/890-803



Item no.890-803/011-000
Socket for PCBs; angled; 3-pole; Cod. A; black www.wago.com/890-803/011-000



Item no.891-8993/005-101
pre-assembled interconnecting cable; Eca; Socket/plug; 3-pole; Cod. A; 1 m; 1,00 mm²; black www.wago.com/891-8993/005-101



Item no.891-8993/105-101
pre-assembled connecting cable; Eca; Socket/open-ended; 3-pole; Cod. A; 1 m; 1,00 mm²; black www.wago.com/891-8993/105-101

Required accessories

Locking levers

Locking system



Item no.: 890-111
Locking lever; for flying leads; for tool operation; black www.wago.com/890-111



Item no.: 890-101
Locking lever; for manual operation; black www.wago.com/890-101



Item no.: 890-121
Locking lever; for manual operation; white www.wago.com/890-121



Item no.: 890-131
Locking lever; for flying leads; for tool operation; white www.wago.com/890-131

Optional accessories

Tool

Operating tool



Item no.: 210-719
Operating tool; Blade: 2.5 x 0.4 mm; with a partially insulated shaft www.wago.com/210-719

Subject to changes. Please also observe the further product documentation!



Item no.: 890-383
Operating tool; 3-way; green

www.wago.com/890-383

Shield termination

Shield termination



Item no.: 890-523
Shield connecting plate; 3-pole; for sockets and plugs; silver-colored

www.wago.com/890-523

Cover

Cover



Item no.: 897-2001
Protective cap; Type1; for sockets and plugs; PVC; red

www.wago.com/897-2001

Mounting

Mounting accessories



Item no.: 890-310
Mounting carrier; 2- to 5-pole; for flying leads; black

www.wago.com/890-310



Item no.: 890-311
Mounting carrier; 2- to 5-pole; for flying leads; white

www.wago.com/890-311

Downloads

Documentation

Bid Text

890-113 X81 - Datei	2019 Feb 19	xml 3.1 kB	Download
890-113 doc - Datei	2015 Jun 8	doc 23.6 kB	Download

CAD/CAE-Data

CAD data

2D/3D Models 890-113	URL	Download
----------------------	-----	----------

CAE data

EPLAN Data Portal 890-113	URL	Download
---------------------------	-----	----------

Subject to changes. Please also observe the further product documentation!

WAGO GmbH & Co. KG
Hansastr. 27
32423 Minden
Phone: +49571 887-0 | Fax: +49571 887-169
Email: info.de@wago.com | Web: www.wago.com

Do you have any questions about our products?
We are always happy to take your call at +49 (571) 887-44222.

ZUKEN Portal 890-113	URL	Download
----------------------	---------------------	--------------------------

WSCAD Universe 890-113	URL	Download
------------------------	---------------------	--------------------------

Environmental Product Compliance

Compliance Search

Environmental Product Compliance 890-113	URL	Download
--	---------------------	--------------------------

Plug; with strain relief housing; 3-pole; 1,50 mm²; black

Installation Notes

Conductor termination

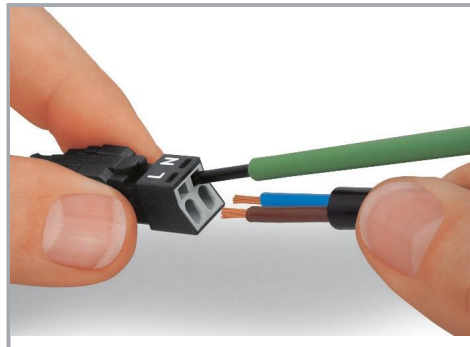
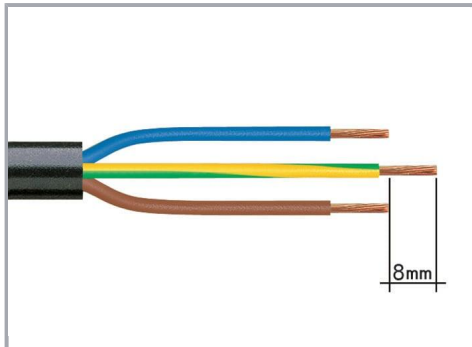

1. Strip length, outer insulation = 30 mm (2-pole), 37 mm (3-pole), 45 mm (4- and 5-pole)

2. Strip length = 9 mm

3. Extended ground conductor = 8 mm

To terminate fine-stranded conductors, open the clamping unit via screwdriver – 2.5 mm blade width – and insert a stripped conductor until it hits the backstop.

Terminate solid conductors by simply pushing them in.

Subject to changes. Please also observe the further product documentation!

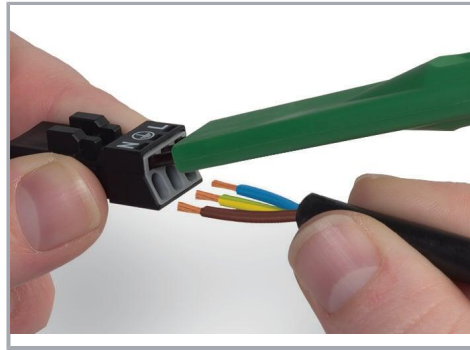
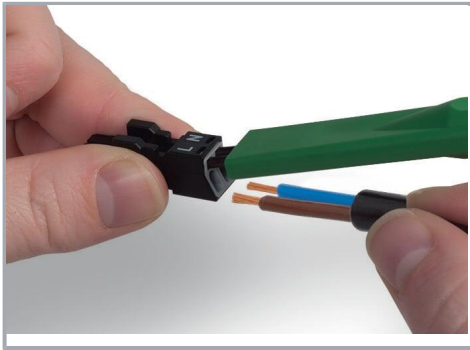

To terminate fine-stranded conductors, open clamping units via operating tool (890-382) and insert stripped conductors until they hit backstop.

To terminate fine-stranded conductors, open clamping units via operating tool (890-383) and insert stripped conductors until they hit backstop.

Terminate solid conductors by simply pushing them in.

Terminate solid conductors by simply pushing them in.

Installation

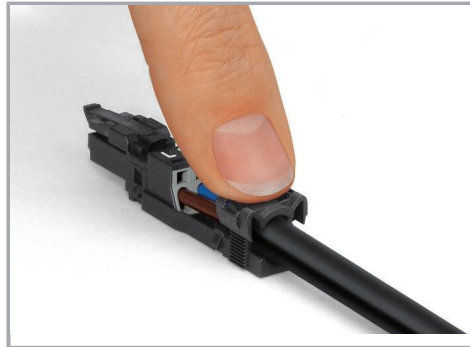
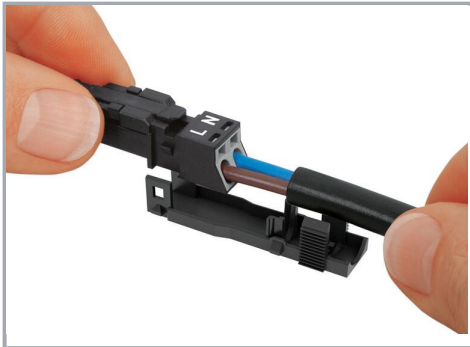

Latch the wired connector into the base of the strain relief housing.

Push down strain relief clamp by hand.

Subject to changes. Please also observe the further product documentation!



Push down strain relief clamp with 2.5 mm screwdriver alternately on both sides.

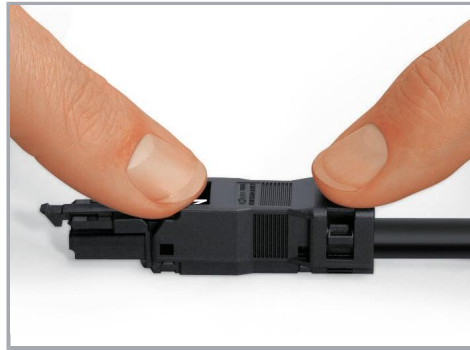

Latch the top of the strain relief housing.



The printed marking of the connector is clearly visible in the openings of the strain relief housing.

Shield termination



Connector with shield termination

Subject to changes. Please also observe the further product documentation!



Apply the shield to the sheathed cable.

Strip length, outer insulation = 30 mm

Shield length = 8 mm



Push the shield connecting plate into the connector until fully inserted.

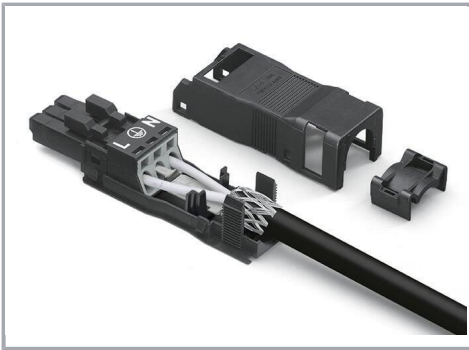

First insert the wired connector into strain relief housing, then snap clamp and cover.

Product family

WINSTA® MINI

[Show all products from the family](#)

Subject to changes. Please also observe the further product documentation!