

ReLog

vibration data logger

User manual & quick start guide
for ReLog S, ReLog M & ReLog L



Important information

Copyright© ReVibe Energy AB 2020. All rights reserved.

Manual version: 002
Firmware version: 0002
VibInspect version: 032



For the latest version of the User Manual & Quick start guide, please scan the QR-code to the right

Safety instructions



When this product has reached the end of its life it must be treated as Waste Electrical & Electronic Equipment (WEEE). Any WEEE marked products must not be mixed with general household waste, but kept separate for the treatment, recovery and recycling of the materials used. Contact your local authority for details of recycling schemes in your area.

Safety guidelines

- Do not discharge the li-ion battery completely as it could lower the capacity of the battery.
- Do not open the casing of the ReLog unless you are qualified as service personnel
- Do not remove and disconnect the li-ion battery from its holder

Table of Contents

| | |
|---|----|
| 1. Quick start guide | 4 |
| 2. Technical specifications | 6 |
| 3. Product overview | 12 |
| – Dimensions | |
| – User interface | |
| – What is included in the box? | |
| – LED indications | |
| 4. Using the ReLog | 16 |
| – Charging the ReLog | |
| – ReLog settings | |
| – Mounting | |
| – Updating the ReLog | |
| 5. VibInspect configuration and analysis software | 22 |
| – Installation & updating | |
| – Viewing & analysing vibrations | |
| – Updating the ReLog | |
| 6. Troubleshooting and Warranty | 24 |

1. Quick start guide

PLUG IN TO CHARGE

Plug in your ReLog to a PC or wall outlet adapter by using the USB cable found in the delivery box. Allow the ReLog to charge until the battery indicator shows green light (up to 9 hours when connected to a USB 2.0 port).

SET SAMPLE RATE



The default sample rate is 32,000 Hz. If you do not want to change this, this step can be skipped.

1. Download and install the VibInspect software
2. Connect the ReLog to your PC and make sure that it is detected
3. Open VibInspect and press "ReLog Settings"
4. Choose the ReLog's root folder from the browser window
5. Set the desired sample rate

MOUNTING THE RELOG

1. Clean the surface/object from dirt, grease or similar
2. Choose a suitable mounting method
3. Attach the ReLog to the surface/object

POWER ON THE RELOG AND START RECORDING

To power on the ReLog, press the On/Off () button. The LED indicator will show a solid green light and then enter standby mode. Press the start/stop () button to start recording. The LED indicator will flash in blue 3 times and then show battery status every 3 seconds.

STOP MEASURING

To stop a recording, simply press the start/stop () button again. The light will once again flash in blue 3 times, and the ReLog will go back to standby mode.

ANALYSING THE VIBRATIONS

Download the VibInspect analysing software through [www.revibeenergy.com / vibinspect-analysing-software/](http://www.revibeenergy.com/vibinspect-analysing-software/) and use the program to better understand the vibrations you have just recorded. For more detailed instructions, see chapter 5.

2. Technical specifications

PHYSICAL & ENVIRONMENTAL

| | |
|---------------------------------|------------------------------|
| Weight | 220 g |
| Dimensions | 103 x 61 x 25.8 mm |
| Operating temperature | -20°C – 60°C (-4°F to 140°F) |
| Calibrated temperature | -20°C – 60°C (-4°F to 140°F) |
| Recommended storage temperature | +10°C – 30°C (50°F to 86°F) |
| Charging temperature | 0°C – 40°C (32°F to 104°F) |
| Shock limit | 2,000 g |
| Casing material | Anodized aluminium |
| IP rating | IP67 |

FEATURES

| | |
|---|-----|
| RTC (Real-time-clock) | Yes |
| Logging while charging over USB (can be connected to power outlet) | Yes |
| CE, RoHS compliant | Yes |

TEMPERATURE SENSOR

| | |
|-------------------------|---|
| Temperature range | -40°C to +150°C (-40°F to 302°F) |
| Accuracy | $\pm 0.20^{\circ}\text{C}$ from -10°C to +85°C (-10 °F to +185°F) at 3.0 V $\pm 0.25^{\circ}\text{C}$ from -20°C to +105°C (-4 °F to +221°F) from 2.7 V to 3.3 V |
| Total temperature drift | 0.00073 °C |
| Resolution | 0.00078 °C |

STORAGE

| | |
|--|--|
| Type of storage | Internal SD card |
| Transfer of data | Via USB cable to PC |
| Storage size | ReLog S: 32 GB ReLog M: 64 GB ReLog L: 128 GB |
| Max. recording length with 32,000 Hz sample rate | ReLog S: 46 hours ReLog M: 93 hours ReLog L: 155 hours |

2. Technical specifications

PRIMARY ACCELEROMETER

| | |
|--|--|
| Accelerometer | Capacitive MEMS |
| Main features | High frequency, high G and low noise |
| Sample rate per axis | 32,000 Hz 16,000 Hz 8,000 Hz 4,000 Hz |
| Bandwidth | -3 dB at 10 kHz |
| Measurement range | +/- 50 g |
| Shock resistance | 10,000 g |
| Resolution | 1.5 mg |
| Noise density | 26 $\mu\text{g}/\sqrt{\text{Hz}}$ |
| Analog anti-aliasing filter cutoff frequency | 10 kHz |
| Digital filter | 32 tap FIR filter |

SECONDARY ACCELEROMETER

| | |
|--|---|
| Accelerometer | Capacitive MEMS |
| Main features | DC accurate, long-term stability and minimal drift versus temperature |
| Sample rate per axis | 4,000 Hz 2,000 Hz 1,000 Hz 500 Hz 250 Hz 125 Hz |
| Bandwidth | -3 dB at 550 Hz |
| Measurement range | +/- 2.048 g +/- 4.096 g +/- 8.192 g |
| Shock resistance | 5,000 g |
| Resolution | 3.9 μg at +/- 2.048 g 7.8 μg +/- 4.096 g 15.6 μg +/- 8.192 g |
| Noise density | 25 $\mu\text{g}/\sqrt{\text{Hz}}$ |
| Analog anti-aliasing filter cutoff frequency | 1.5 kHz |
| Digital filter | Sinc type |
| Drift | 0.15 mg/C maximum, 0.02 mg/C typical |

2. Technical specifications

BATTERY SPECIFICATIONS

| | |
|------------------------------------|--|
| Chemistry | Rechargeable Lithium-Ion |
| Nominal capacity | ReLog S: 2,600 mAh ReLog M: 3,000 mAh ReLog L: 3,400 mAh |
| Minimum capacity | ReLog S: 2,500 mAh ReLog M: 2,900 mAh ReLog L: 3,300 mAh |
| Operating temperature | -20°C – 60°C (-4°F to 140°F) |
| Storage temperature | 1 month: -20°C – 60°C (-4°F to 140°F) 3 months: -20°C – 45°C (-4°F to 49°F) 1 year: -20°C – 20°C (-4°F to 4°F) |
| Battery life at full sampling rate | Approximately 150 hours |

3. Product overview

Dimensions

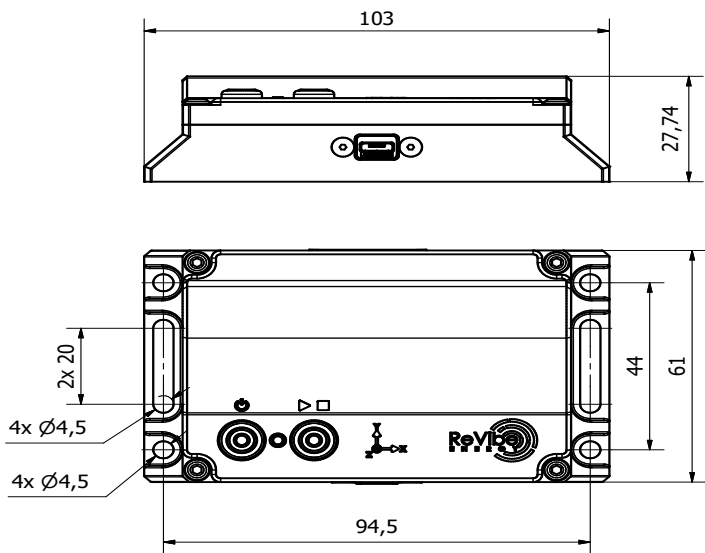

Interface

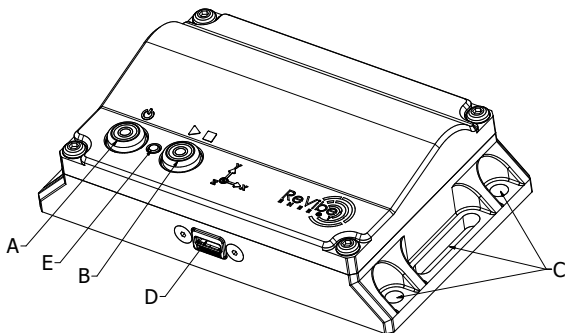

Interface legend

A = On/Off button 

B = Start/stop button 

C = Holes for mounting screws

D = USB interface for file transfer and charging

E = LED indicator



What is included in the box?

When you receive your ReLog, you will find the following items in the box:



















- 1 ReLog vibration data logger
- 1 Connecting USB cable for data transfer and charging
- 1 User manual & Quick start guide
- 4 pcs of mounting magnets
- Mounting tape (3M 950 transfer tape)
- 4 pcs of mounting screws

3. Product overview

Battery LED indicator

| COLOUR | BATTERY CHARGE STATE |
|---|----------------------|
|  | Over 80 % |
|  | 20 % - 80 % |
|  | Under 20 % |

LED functionality indicator

| STATE | INDICATION |
|----------------------|--|
| Powering on |  (1 s) |
| Stand-by |  (solid) +  /  /  (flashing every 3 s) |
| Starting measurement |    (flashing) |
| Measuring |  /  /  (flashing every 3 s) |
| Stopping measurement |    (flashing) |
| Update mode |    (flashing) |
| Powering off |  (3 s) |

4. Using the ReLog

Charging the ReLog

In the box in which you received the ReLog, you will also find a USB cable that you should use to connect the ReLog to a PC.

When you receive your ReLog unit, the charge level of the battery will be below 30%. As a result, if you plan to measure vibrations for a longer period of time, make sure that you give enough time to charge the ReLog properly.

Depending on which version of the ReLog you have in your hands, the charge time to fully charge the battery will vary a bit as the different versions of the ReLog have different battery sizes. The maximum charging time should not exceed 9 hours for the largest battery size.

ReLog settings

There are two ways of setting the sample rate and choosing accelerometer for the ReLog:

Option 1 - Using VibInspect (recommended)

Having the ReLog plugged in to your PC, open VibInspect and press the "ReLog settings" button. Choose the ReLog root folder, which will be listed as a USB flash drive. Please note that the location of the USB/External drives might vary depending on the settings of your computer and whether other flash drives are connected.

Once completed, a new dialogue box will appear where you can set different measurement parameters. First, you can choose to use either the primary or the secondary accelerometer depending on whether you are doing low-acceleration and low-frequency measurements or high-acceleration and high-frequency measurements.

For the primary accelerometer, you can choose between the sample rates 32,000, 16,000, 8,000, and 4,000 Hz, and for the secondary accelerometer, you can choose between 4,000, 2,000, 1,000, 500, 250, and 125 Hz. The secondary accelerometer also has three selectable measurement ranges: 8.192, 4.094, and 2.048 g. Lastly, you can choose whether or not to log temperature and battery voltage by toggling yes/no in the corresponding box. When you are pleased with the settings, press OK and a dialog box will tell you that the settings were successfully saved.

At factory setting, the ReLog uses the primary accelerometer at 32 kHz and logs both temperature and battery voltage.

Option 2 - use the _settings file

When connecting the ReLog to a PC, you can find the settings file in the ReLog root folder (“_settings”). You can use any text editor to directly edit the measurement settings in this file. The structure is that of an .ini file where key value pairs are separated with an equals sign. An example of the settings file is shown below

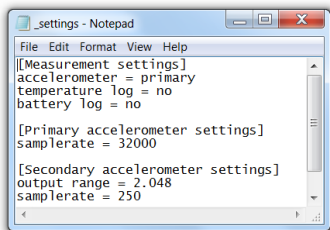

The available values to each parameter is shown in bold in the previous paragraph “Option 1 -Using VibInSpect (recommended)”.

4. Using the ReLog

Mounting

How you mount the ReLog is the most important aspect for you as a user when it comes to making sure that the measurements will be as good as they possibly can be. Why? Simply because if the vibration transfer is not perfect it will mean that the ReLog cannot fully utilise its capabilities and measure the vibrations accurately.

To avoid inaccurate results, the following information should be taken into account.

Preparations before mounting:

Make sure that the surface on which the ReLog will be mounted is free from the following:

- Oil
- Grease
- Dirt
- Excessive amounts of dust
- Water/moist

To ensure this, clean the surface with an industrial cleaner. Make sure that you, after having cleaned the surface, wipe it off properly so that there is no trace of liquids or moisture on the surface.

Done? Then you are ready to proceed to the next step!

Mounting methods

There are numerous ways to mount an accelerometer (we will cover most of them below) and as stated above, the choice of method has a big impact on the results of the measurements. We would recommend them in the order as follows:

- Mounting with screws/studs
- Mounting with adhesive tape
- Mounting with magnets
- Mounting with wax/glue

Mounting with screws/studs

Using screws/studs is the best option but it does require drilling holes in the object that you would like to monitor. If you can do this, great! You will find that this will ensure most accurate results when measuring at higher frequencies. We recommend using two screws/studs on each side of the ReLog to ensure that the unit is firmly attached to the object.

Mounting by double-sided tape

This will most likely be the go-to option for most users of the ReLog as it is likely that you do not wish to drill holes into the object you are measuring on. Each ReLog comes with several strips of double-sided tape from 3M that you attach to the bottom of the ReLog.

Mounting with magnets

Using magnets to mount the ReLog is a third approach if one of the two above does not work for you.

There are many upsides to using magnets, such as them making it very easy to mount and demount the ReLog. However, when using magnets you will limit your ability to measure higher frequencies as magnets filter away most vibrations found in frequencies above 1000 Hz. If higher frequencies are important for your analysis, please use screws/studs or double-sided tape.

Mounting with wax/glue

If none of the above fits your purpose you can always use wax/glue to mount the ReLog. Please do keep in mind that when you use wax/glue it can be fairly tricky to remove all remains from the ReLog after the measurement has been completed.

Please also keep in mind that most wax filters out high-frequency vibrations, so the resolution on your measurements will be worse if you are looking to analyse high frequencies.

Other mounting methods?

From experience, we know that each environment is different from the previous one and that sometimes you have to be a bit creative when it comes to mounting the ReLog. We strongly recommend that you use the mounting alternatives suggested above, but if you have any questions around your specific environment please do reach out to us and we will be happy to advise what we feel would be best.

4. Using the ReLog

Measuring

Below, you will find an instruction on how to proceed to get started with your measurements.

Turn the ReLog on

Turning on the ReLog is a simple task! Simply press the On/off button () and the LED indicator will show a steady green light, followed by a steady blue light with battery status indication every 3 seconds. The ReLog is now in standby mode.

Start measurements

To start measuring, press the Start/stop button () once. The LED indicator will flash in blue 3 times. The ReLog is now measuring. During measurement, the LED indicator flashes to indicate the battery status every 3 seconds.

Stop measurements

To stop a measurement, simply press the Start/stop button () again. The LED indicator will once again flash in blue 3 times, and the ReLog will go back to standby mode.

To turn the logger off, press and hold the On/off button () for 3 seconds when the logger is in stand-by mode.

5. VibInspect software

Installation & updating

Start by downloading the VibInspect software from revibeenergy.com/vibinspect-analysing-software/.

Go ahead and open the .msi file that will be located in your download folder. The installer will be started and you can simply follow the given instructions to install the software.

Once installed, Vibinspect will automatically check for updates on our server every time it is started. Please allow updates to be installed as we are continuously adding new features and improving the stability of the software, to ensure we continue to provide a great analysing tool for you.

Viewing & analysing vibrations

Step 1

Once VibInspect is running, you will see a top menu with a number of choices:

Before you have opened a measurement file, "Open" and "ReLog settings" are the only two buttons that you can press.

"ReLog Settings" - Press this button to prompt a dialogue box where you can choose the sampling frequency you would like to use.

"Open" - Press this button to open a dialogue window where you can choose which file you want to open. If it is a file that has been recorded with the ReLog, simply locate the root folder of the ReLog which will be shown as an external drive and locate the file you would like to analyse.

Step 2

Once you have opened a measurement file, you can choose between the following options:

"Export" - Used to export the measurement file and to convert from .wav format to .csv format.

"Downsample" - Reduces the sampling rate of the signal. Useful for reducing the file size, if the signal was sampled with an excessively high sampling rate. Please note that in a signal sampled at rate f , the highest observable frequency is $f/2$, which is called the Nyquist frequency.

"FFT" - Calculates the discrete Fourier transform of the signal. This provides information about the average spectral content in the signal. The resolution of the FFT is directly proportional to the length of the measurement and the sample rate used.

“PSD” - The PSD is based on the FFT algorithm, but normalizes the values to frequency bin width. Practically, this reduces the influence of sampling duration on the spectrum. If a random signal is sampled for 10 seconds, or 100 seconds, the spectral content will appear to be different if using FFT, although the signal is similar throughout the measurement. With the PSD however, they will be similar, despite the difference in signal length.

“Spectrogram” - A spectrogram is computed by calculating several FFTs, each for an individual segment of the time-domain signal. The segments together span the entire signal, and may be overlapping. This gives insight into how the frequency content changes over time in the signal. It may be useful for e.g. tracking how the operating speed of a motor changes throughout the measurement.

Step 3

The Vibinspect allows the user to perform multiple analyses on the same measurement file. Simply press FFT, PSD, or Spectrogram to perform additional analyses.

It is also possible to open several measurement files at the same time.

Updating the ReLog

Firmware upgrades that improve battery life, introduce functionality, increase stability and fix potential bugs are continually implemented to make sure that ReLog meets expectations and requirements.

New firmware updates along with features and fixes are announced in VibInspect. The current firmware version of your ReLog device is shown in the VibInspect software when connecting it to a PC.

An update is performed by first setting the ReLog in update mode. This is done by holding the Start/stop (▶■) button while inserting the USB cable into a PC. A steady teal light indicates that the device has entered update mode. Open VibInspect and follow the instructions under the “ReLog Settings” tab to proceed with updating the unit.

6. Troubleshooting and Warranty

Troubleshooting

Initial note:

Sometimes it can happen that the ReLog displays an abnormal behavior that you did not expect to see. As a first resort, always reset the ReLog by turning it off and on again. If the ReLog does not respond to this, charge the unit for 1 hour by connecting it to a PC and try again.

My ReLog does not react and the LED indicator is not blinking

If the ReLog does not respond when you turn it on, please verify that there is enough energy in the battery. To ensure this, connect the ReLog to a PC and allow it to charge for 1 hour. This will not charge the battery to 100% but will give you enough power to verify functionality.

If the ReLog still is unresponsive after this, make a note of the measures you have taken and contact us at ReVibe for further support at contact@revibeenergy.com. Please describe the problem as detailed as possible and let us know the serial number of your unit (displayed on the label on the side of ReLog) and we will get back to you with suggested actions.

The ReLog does not appear when I connect it to a PC

Please allow some time to pass (up to 20 seconds) as it sometimes might take some time for your computer to properly read and accept the ReLog as an external device. This issue could, in particular, occur when you are using the ReLog L, as the ReLog L has such a large internal memory that it might take some time for your PC to scan the memory card and recognise the ReLog as an external device.

If this problem does not go away by itself by waiting for 20 seconds, disconnect the ReLog and connect it to the PC again. If this does not solve the issue, please reach out to us at contact@revibeenergy.com and describe the issue in an email where you also include your product serial number.

The ReLog shows a bright red light

A bright red light indicates that the ReLog has entered a general error state. This should not occur and might be due to a firmware bug or faulty hardware. By pressing the On/off button (), the ReLog resets, hopefully without any errors. The research and development team would appreciate it if you make a note of what happened prior to the event and tell us more about the unit so that we can fix the issue and if possible implement a firmware patch (contact@revibeenergy.com).

Product Warranty

For product warranty information, please see <https://revibeenergy.com/terms-of-service/>



Copyright© ReVibe Energy AB 2020