

SERIES: PX078-500-M | **DESCRIPTION:** NON-ISOLATED DC SWITCHING REGULATOR

FEATURES

- ultra-thin SMD package
- open frame
- efficiency up to 95%
- no-load input current as low as 0.2 mA
- -40°C ~ 85°C temperature range
- designed to meet EN/UKCA 62368
- output short circuit protection

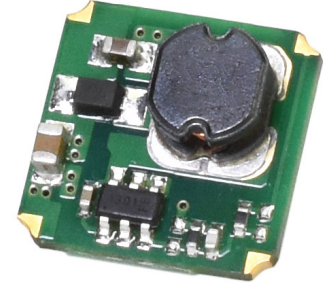

MODEL

MODEL	input voltage ¹		output voltage (Vdc)	output current max (mA)	output power max (W)	ripple & noise ² max (mVp-p)	efficiency ³ typ (%)
	typ (Vdc)	range (Vdc)					
PX07803-500-M-TR	24	4.75~36	3.3	500	1.65	100	85
PX07805-500-M-TR	24	6.5~36	5	500	2.5	100	90
PX07806-500-M-TR	24	8~36	6.5	500	3.25	100	91
PX07809-500-M-TR	24	12~36	9	500	4.5	100	93
PX07812-500-M-TR	24	15~36	12	500	6.0	100	94
PX07815-500-M-TR	24	19~36	15	500	7.5	100	95

Notes:

1. For input voltages higher than 30 Vdc, a 22 μ F / 50 V input capacitor is required.
2. Tested at nominal input, 30~100% load for 3.3 Vdc model, 20 MHz bandwidth.
At loads below 30%, the max ripple and noise of the 3.3 Vdc output will be 200 mVp-p, and a load below 20% for the other outputs the levels increase to 250 mVp-p..
3. Measured at min V_{in} , full load.
4. All specifications are measured at $T_a=25^\circ\text{C}$, humidity < 75%, nominal input voltage, and rated output load unless otherwise specified.

PART NUMBER KEY

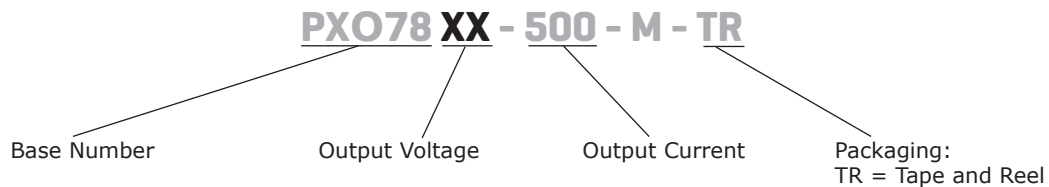

INPUT

parameter	conditions/description	min	typ	max	units
operating input voltage			24	36	Vdc
input reverse polarity protection	no				
no-load input current			0.2	1.5	mA
filter	capacitor filter				

OUTPUT

parameter	conditions/description	min	typ	max	units
maximum capacitive load				680	μF
voltage accuracy	at full load, input voltage range		±2	±4	%
	3.3 Vdc output model all other models		±2	±3	%
line regulation	at full load, input voltage range		±0.3	±0.5	%
load regulation	at nominal input, 10~100% load		±0.6	±1	%
switching frequency	at nominal input voltage, full load		700		kHz
transient recovery time	at nominal input voltage, 25% load step change		0.2	1	ms
transient response deviation	at nominal input voltage, 25% load step change		±50	±250	mV
temperature coefficient	at full load		±0.02		%/°C

PROTECTIONS

parameter	conditions/description	min	typ	max	units
short circuit protection	continuous, auto recovery				

SAFETY AND COMPLIANCE

parameter	conditions/description	min	typ	max	units
safety approvals	designed to meet 62368: EN/IEC/UKCA				
conducted emissions	CISPR32/EN55032 CLASS B (see Fig. 4-2 for recommended circuit)				
radiated emissions	CISPR32/EN55032 CLASS B (see Fig. 4-2 for recommended circuit)				
ESD	IEC/EN 61000-4-2 Contact ±4kV, perf. Criteria B				
radiated immunity	IEC/EN 61000-4-3 10V/m, perf. Criteria B				
EFT/burst	IEC/EN 61000-4-4 100kHz±1kV (see Fig. 4-1 for recommended circuit), perf. Criteria B				
surge	IEC/EN 61000-4-5 ±1kV (see Fig. 4-1 for recommended circuit), perf. Criteria B				
conducted immunity	IEC/EN 61000-4-6 3Vr.m.s, perf. Criteria B				
MTBF	as per MIL-HDBK-217F, 25°C		2,000 000		hours
RoHS	yes				

ENVIRONMENTAL

parameter	conditions/description	min	typ	max	units
operating temperature	see derating curve	-40		85	°C
storage temperature		-55		125	°C
storage humidity	non-condensing	5		95	%

SOLDERABILITY

parameter	conditions/description	min	typ	max	units
reflow soldering	Peak temp. ≤245°C, maximum duration time ≤60s over 217°C. Please refer to IPC/JEDEC J-STD-020D.1			260	°C

MECHANICAL

parameter	conditions/description	min	typ	max	units
dimensions	12 x 12 x 4.5 [0.472 x 0.472 x 0.177 inch]				mm
weight			0.75		g
cooling method	natural convection				

MECHANICAL DRAWING

units: mm [inch]
tolerance: ±0.25[±0.010]

PIN-OUT	
PIN	FUNCTION
1	+Vin
2	NC
3	+Vo
4	GND

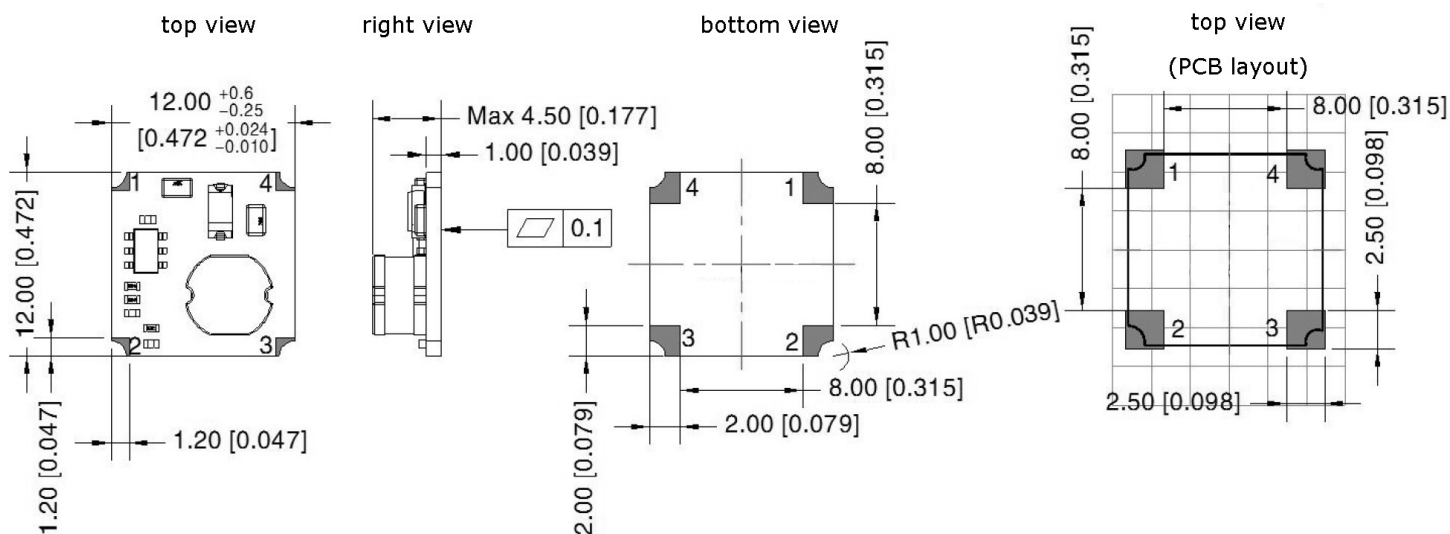

DERATING CURVE

Figure 1

TEMPERATURE DERATING CURVE

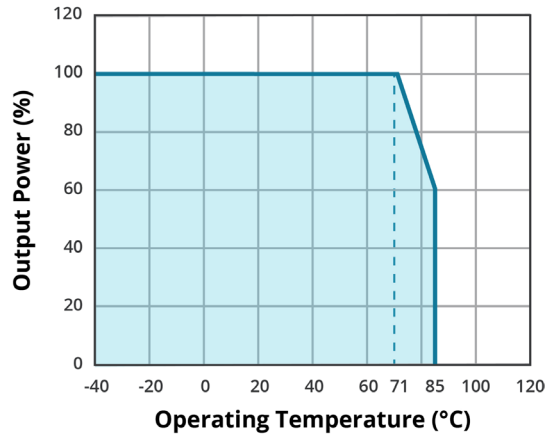

EFFICIENCY CURVES

EFFICIENCY VS INPUT VOLTAGE
PX07805-500-M
(full load)

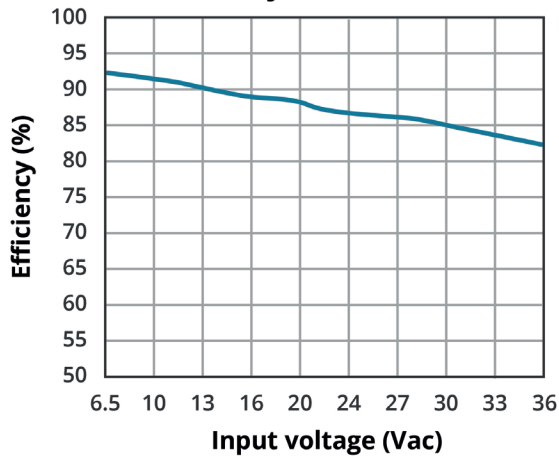

EFFICIENCY VS OUTPUT LOAD
PX07805-500-M
(Vin = 24 V)

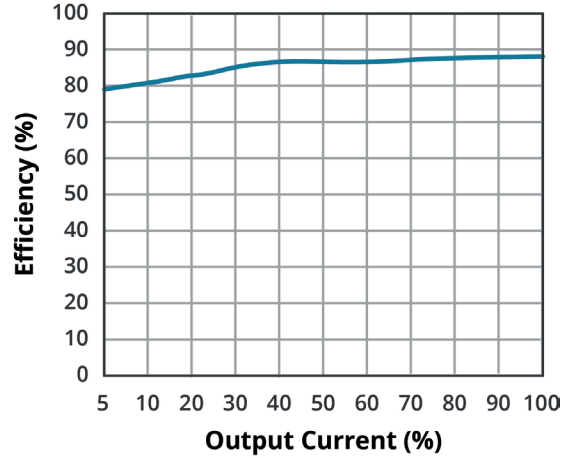

EFFICIENCY VS INPUT VOLTAGE
PX07815-500-M
(full load)

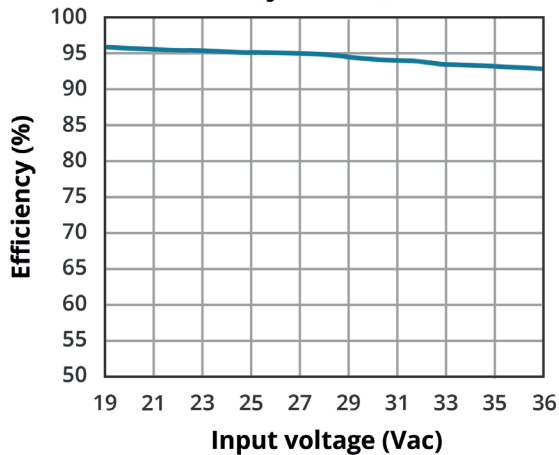

EFFICIENCY VS OUTPUT LOAD
PX07815-500-M
(Vin = 24 V)

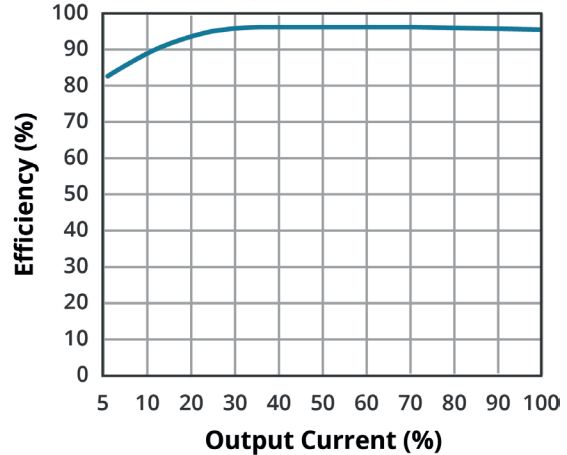

TYPICAL APPLICATION CIRCUIT

Figure 2

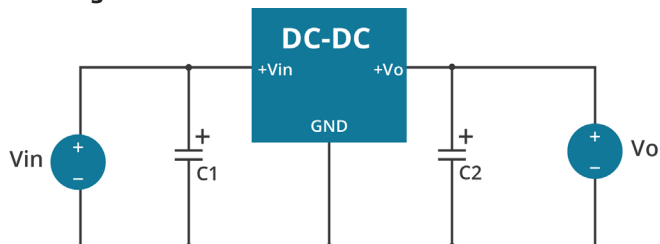

Table 1

External Capacitor Table		
Model Number	C1 (ceramic capacitor)	C2 (ceramic capacitor)
PXO7803-500-M-TR	10 μ F/50 V	22 μ F/10 V
PXO7805-500-M-TR	10 μ F/50 V	22 μ F/10 V
PXO7806-500-M-TR	10 μ F/50 V	22 μ F/16 V
PXO7809-500-M-TR	10 μ F/50 V	22 μ F/16 V
PXO7812-500-M-TR	10 μ F/50 V	22 μ F/25 V
PXO7815-500-M-TR	10 μ F/50 V	22 μ F/25 V

- Note:
1. The required C1 and C2 capacitors must be connected as close as possible to the terminals of the module.
 2. Refer to Table 1 for C1 and C2 capacitor values. For certain applications, increased values and/or tantalum or low ESR electrolytic capacitors may also be used instead.
 3. Converter cannot be used for hot swap or with output in parallel.
 4. To further reduce the output ripple and noise, we suggested the use of a "LC" filter at the output terminals, with an inductor value (L) of 10 μ H-47 μ H.

Figure 3

External "LC" output filter circuit diagram

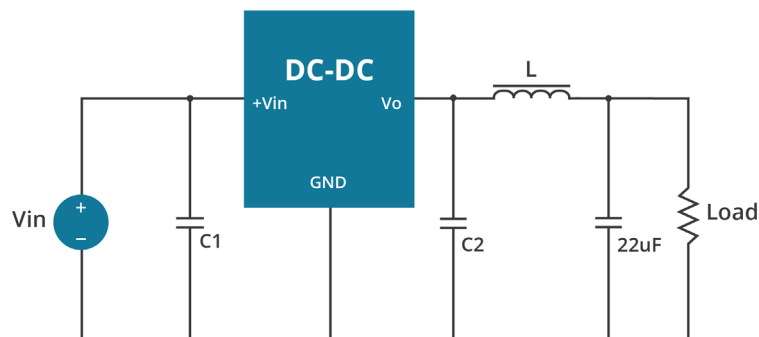

EMC RECOMMENDED CIRCUIT

Figure 4

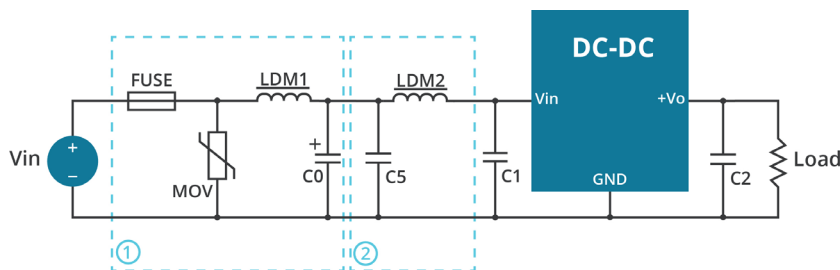

Table 2

Recommended external circuit components	
FUSE	choose according to actual input current
MOV	S20K30
LDM1	82 μ H
C0	680 μ F/50 V
C1 / C2	see Table 1
C5	4.7 μ F/50 V
LDM2	22 μ H

- Note: For EMC tests we use Part ① in Fig. 4 for immunity and part ② for emissions test. Selecting based on needs.

REVISION HISTORY

rev.	description	date
1.0	initial release	08/30/2022

The revision history provided is for informational purposes only and is believed to be accurate.



Headquarters
20050 SW 112th Ave.
Tualatin, OR 97062
800.275.4899

Fax 503.612.2383
cui.com
techsupport@cui.com

CUI offers a two (2) year limited warranty. Complete warranty information is listed on our website.

CUI reserves the right to make changes to the product at any time without notice. Information provided by CUI is believed to be accurate and reliable. However, no responsibility is assumed by CUI for its use, nor for any infringements of patents or other rights of third parties which may result from its use.

CUI products are not authorized or warranted for use as critical components in equipment that requires an extremely high level of reliability. A critical component is any component of a life support device or system whose failure to perform can be reasonably expected to cause the failure of the life support device or system, or to affect its safety or effectiveness.