

PECL and LVDS Low Phase Noise XO (32.5 to 130MHz output)

FEATURES

- 65MHz to 130MHz Crystal input.
- Output range: 32.5MHz – 130MHz (no PLL).
- Low Injection Power for crystal, 50uW.
- Complementary outputs: PECL or LVDS.
- Selectable OE Logic
- Supports 2.5V or 3.3V-Power Supply.
- Available in die form.
- Thickness 8 mil.

DESCRIPTION

The PL620-30 is a XO IC specifically designed to drive fundamental or 3rd OT crystals from 65MHz to 130MHz, with selectable PECL or LVDS outputs and OE logic (enable high or enable low). Its design was optimized to tolerate higher limits of interelectrode capacitance and bonding capacitance to improve yield. It achieves very low current into the crystal resulting in better overall stability.

DIE SPECIFICATIONS

Name	Value
Size	62 x 65 mil
Reverse side	GND
Pad dimensions	80 micron x 80 micron
Thickness	8 mil

BLOCK DIAGRAM

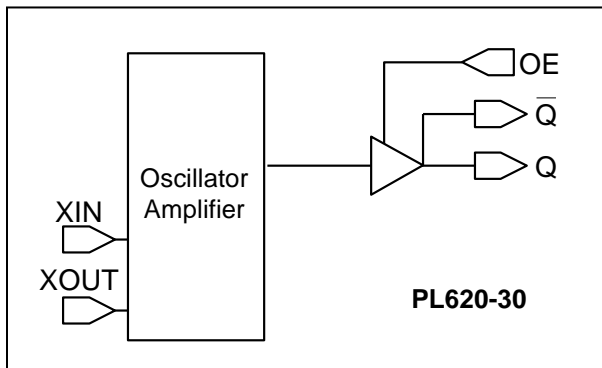

DIE CONFIGURATION

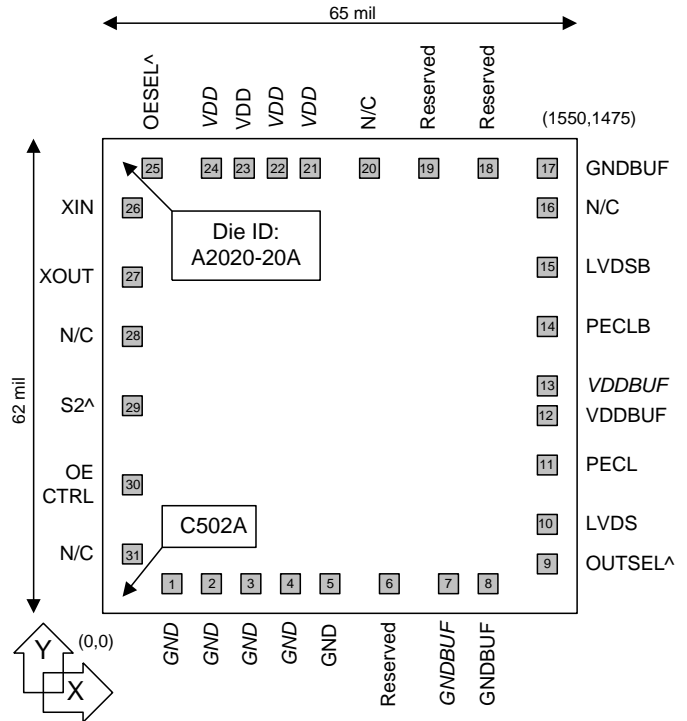

OUTPUT SELECTION AND ENABLE

OUTSEL (Pad #9)	Selected Output
0	LVDS
1	PECL (default)

OESEL (Pad #25)	OE_CTRL (Pad #30)	State
0	0	Tri-state
	1	Output enabled (default)
1 (default)	0	Output enabled (default)
	1	Tri-state

Pad #9, #25: Bond to GND to set to "0". Internal pull up.

Pad #30: Logical states defined by PECL levels if OESEL is "1"
Logical states defined by CMOS levels if OESEL is "0"

OUTPUT FREQUENCY SELECTOR

S2	Output
0	Input/2
1(Default)*	Input

*Internally set to 'Default' through 60KΩ pull-up resistor

PECL and LVDS Low Phase Noise XO (32.5 to 130MHz output) ELECTRICAL SPECIFICATIONS

1. Absolute Maximum Ratings

PARAMETERS	SYMBOL	MIN.	MAX.	UNITS
Supply Voltage	V_{DD}		4.6	V
Input Voltage, dc	V_i	-0.5	$V_{DD}+0.5$	V
Output Voltage, dc	V_o	-0.5	$V_{DD}+0.5$	V
Storage Temperature	T_s	-65	150	°C
Ambient Operating Temperature*	T_A	-40	85	°C
Junction Temperature	T_j		125	°C
Lead Temperature (soldering, 10s)			260	°C
ESD Protection, Human Body Model			2	kV

Exposure of the device under conditions beyond the limits specified by Maximum Ratings for extended periods may cause permanent damage to the device and affect product reliability. These conditions represent a stress rating only, and functional operations of the device at these or any other conditions above the operational limits noted in this specification is not implied.

2. Crystal Specifications

PARAMETERS	SYMBOL	CONDITIONS	MIN.	TYP.	MAX.	UNITS
Built-in Capacitance	CX+	65MHz to 130MHz ($V_{DD}=3.3V$)			2	pF
	CX-				2	
Inter-electrode capacitance	C_0			2.6		
Oscillation Frequency	OF	Fund.	65		130	MHz

3. General Electrical Specifications

PARAMETERS	SYMBOL	CONDITIONS	MIN.	TYP.	MAX.	UNITS
Supply Current (Loaded Outputs)	I_{DD}	PECL/LVDS			100/80	mA
Operating Voltage	V_{DD}		2.25		3.63	V
Output Clock Duty Cycle		@ 1.25V (LVDS) @ $V_{DD} - 1.3V$ (PECL)	45 45	50 50	55 55	%
Short Circuit Current				±50		mA

4. Jitter Specifications

PARAMETERS	CONDITIONS	MIN.	TYP.	MAX.	UNITS
Period jitter RMS	77.76MHz		2.5		ps
Period jitter peak-to-peak	77.76MHz		18.5		ps
Integrated jitter RMS	Integrated 12 kHz to 20 MHz at 77.76MHz		0.5		ps

5. Phase Noise Specifications

PARAMETERS	FREQUENCY	@10Hz	@100Hz	@1kHz	@10kHz	@100kHz	UNITS
Phase Noise relative to carrier	77.76MHz	-75	-95	-125	-145	-155	dBc/Hz

PECL and LVDS Low Phase Noise XO (32.5 to 130MHz output)
6. LVDS Electrical Characteristics

PARAMETERS	SYMBOL	CONDITIONS	MIN.	TYP.	MAX.	UNITS
Output Differential Voltage	V_{OD}	$R_L = 100 \Omega$ (see figure)	247	355	454	mV
V_{DD} Magnitude Change	ΔV_{OD}		-50		50	mV
Output High Voltage	V_{OH}			1.4	1.6	V
Output Low Voltage	V_{OL}		0.9	1.1		V
Offset Voltage	V_{OS}		1.125	1.2	1.375	V
Offset Magnitude Change	ΔV_{OS}		0	3	25	mV
Power-off Leakage	I_{OXD}	$V_{out} = V_{DD}$ or GND $V_{DD} = 0V$		± 1	± 10	μA
Output Short Circuit Current	I_{OSD}			-5.7	-8	mA

7. LVDS Switching Characteristics

PARAMETERS	SYMBOL	CONDITIONS	MIN.	TYP.	MAX.	UNITS
Differential Clock Rise Time	t_r	$R_L = 100 \Omega$ $C_L = 10 \text{ pF}$ (see figure)	0.2	0.7	1.0	ns
Differential Clock Fall Time	t_f		0.2	0.7	1.0	ns

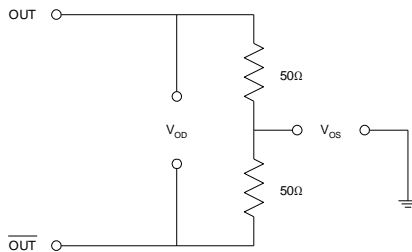
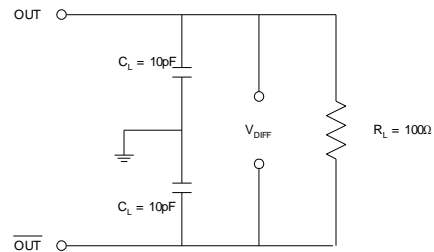
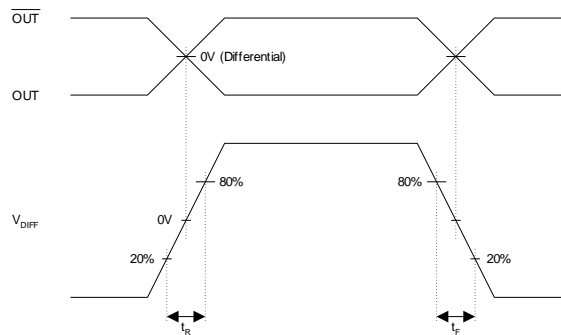
LVDS Levels Test Circuit

LVDS Switching Test Circuit

LVDS Transition Time Waveform

PECL and LVDS Low Phase Noise XO (32.5 to 130MHz output)

8. PECL Electrical Characteristics

PARAMETERS	SYMBOL	CONDITIONS	MIN.	MAX.	UNITS
Output High Voltage	V_{OH}	$R_L = 50 \Omega$ to $(V_{DD} - 2V)$ (see figure)	$V_{DD} - 1.025$	$V_{DD} - 0.750$	V
Output Low Voltage	V_{OL}		$V_{DD} - 1.900$	$V_{DD} - 1.620$	V

9. PECL Switching Characteristics

PARAMETERS	SYMBOL	CONDITIONS	MIN.	TYP.	MAX.	UNITS
Clock Rise Time	t_r	@20/80% - PECL	0.3	0.6	1.5	ns
Clock Fall Time	t_f	@80/20% - PECL	0.3	0.5	1.5	ns

PECL Levels Test Circuit

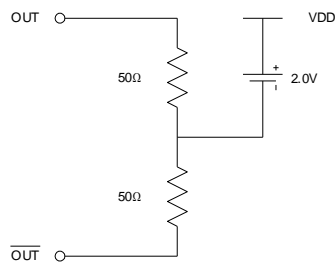

PECL Output Skew

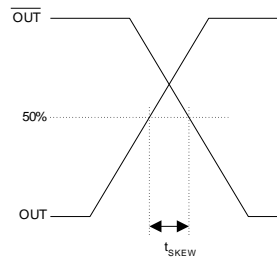

PECL Transition Time Waveform

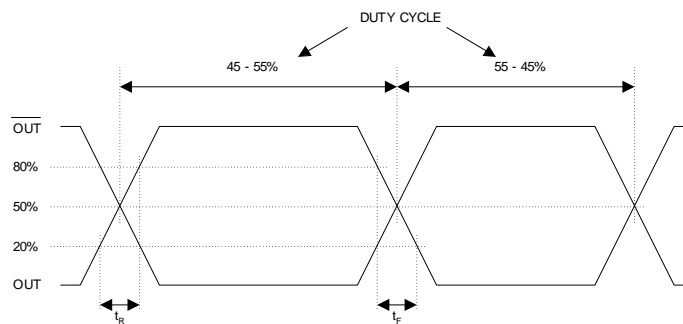

PECL and LVDS Low Phase Noise XO (32.5 to 130MHz output)
PAD ASSIGNMENT

Pad #	Name	X (μm)	Y (μm)	Description
1	<i>Optional GND</i>	248	109	Optional Ground.
2	<i>Optional GND</i>	361	109	Optional Ground.
3	<i>Optional GND</i>	473	109	Optional Ground.
4	<i>Optional GND</i>	587	109	Optional Ground.
5	GND	702	109	Ground.
6	<i>Reserved</i>	874	109	Reserved for future use.
7	<i>Optional GNDBUF</i>	1042	109	Optional Ground, buffer circuitry.
8	GNDBUF	1171	109	Ground, buffer circuitry.
9	OUTSEL	1400	125	Output type selector. Internal pull up. See Output Selection and Enable table on page 1. Internal pull up.
10	LVDS	1400	259	LVDS output.
11	PECL	1400	476	PECL output.
12	VDDBUF	1400	616	Power supply, buffer circuitry.
13	<i>Optional VDDBUF</i>	1400	716	Optional Power supply, buffer circuitry.
14	PECLB	1400	871	Complementary PECL output.
15	LVDSB	1400	1089	Complementary LVDS output.
16	<i>Not connected</i>	1400	1227	Not Connected.
17	GNDBUF	1389	1365	Ground, buffer circuitry.
18	<i>Reserved</i>	1232	1365	Reserved for future use.
19	<i>Reserved</i>	1042	1365	Reserved for future use.
20	<i>Not connected</i>	854	1365	Not Connected.
21	<i>Optional VDD</i>	659	1365	Optional Power supply.
22	<i>Optional VDD</i>	559	1365	Optional Power supply.
23	VDD	459	1365	Power supply.
24	<i>Optional VDD</i>	358	1365	Optional Power supply.
25	OESEL	194	1365	Used to choose between PECL and CMOS OE logic levels. See Output Selection and Enable table on page 1. Internal pull up
26	XIN	109	1223	Crystal input. See Crystal Specifications on page 2.
27	XOUT	109	1017	Crystal output. See Crystal Specifications on page 2.
28	<i>Not connected</i>	109	858	Not Connected.
29	S2	109	646	Used to select output divider. Internal pull up.
30	OE_CTRL	109	397	Used to enable/disable the output(s). See Output Selection and Enable table on page 1.
31	<i>Not connected</i>	109	181	Not connected.

Note: for optimal Phase Noise performance, it is recommended to bond all optional VDD and GND pads.

PECL and LVDS Low Phase Noise XO (32.5 to 130MHz output)

ORDERING INFORMATION

For part ordering, please contact our Sales Department:

2180 Fortune Drive, San Jose, CA 95131, USA

Tel: (408) 944-0800 Fax: (408) 474-1000

PART NUMBER

The order number for this device is a combination of the following:
Device number, Package type and Operating temperature range

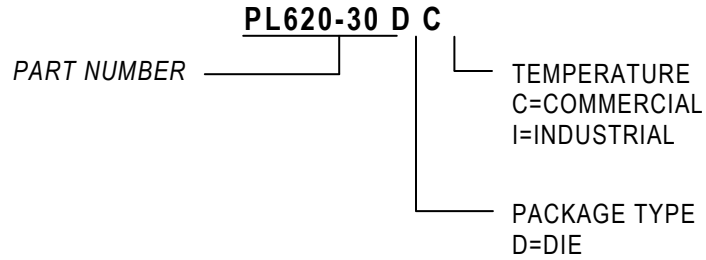

<u>Order Number</u>	<u>Marking</u>	<u>Package Option</u>
PL620-30DC	P620-30DC	Die – Waffle Pack

Micrel Inc., reserves the right to make changes in its products or specifications, or both at any time without notice. The information furnished by Micrel is believed to be accurate and reliable. However, Micrel makes no guarantee or warranty concerning the accuracy of said information and shall not be responsible for any loss or damage of whatever nature resulting from the use of, or reliance upon this product.

LIFE SUPPORT POLICY: *Micrel's products are not authorized for use as critical components in life support devices or systems without the express written approval of the President of Micrel Inc.*