

## ANT-W63-MON-ccc WiFi 6 Monopole Whip Antenna

The Linx ANT-W63-MON series antenna is a compact monopole tilt/swivel whip antenna designed for superior performance in the 2.4 GHz, 5 GHz and 6 GHz bands supporting both WiFi 6 and WiFi 6E.

The ANT-W63-MON antennas work with multiple ground plane configurations and the hinged design allows for the antenna to be positioned for optimum performance.

The antenna is available with an SMA plug (male pin) or RP-SMA plug (female socket) connector.



### Features

- Performance at 2.4 GHz
  - VSWR:  $\leq 2.2$
  - Peak Gain: 3.2 dBi
  - Efficiency: 65%
- Performance at 5.150 GHz to 7.125 GHz
  - VSWR:  $\leq 2.3$
  - Peak Gain: 4.2 dBi
  - Efficiency: 62%
- Hinged design with detents for straight, 45 degree and 90 degree positioning

### Applications

- WiFi/WLAN coverage
  - WiFi 6E (802.11ax)
  - WiFi 6 (802.11ax)
  - WiFi 5 (802.11ac)
  - WiFi 4 (802.11n)
  - 802.11b/g
- 2.4 GHz ISM applications
  - Bluetooth®
  - ZigBee®
- U-NII bands 1-8
- C-V2X (Cellular Vehicle to Everything)
- DSRC (Dedicated Short Range Communications)
- Internet of Things (IoT) devices
- Smart Home networking
- Sensing and remote monitoring

### Ordering Information

Part Number	Description
ANT-W63-MON-RPS	WiFi 6/WiFi 6E monopole whip antenna with RP-SMA plug (female socket)
ANT-W63-MON-SMA	WiFi 6/WiFi 6E monopole whip antenna with SMA plug (male pin)

Available from Linx Technologies and select distributors and representatives.

Table 1. Electrical Specifications

ANT-W63-MON	ISM/WiFi	WiFi/U-NII 1-3	WiFi 6E
Frequency Range	2400 MHz to 2485 MHz	5150 MHz to 5850 MHz	5925 MHz to 7125 MHz
VSWR (max.)	2.4	2.3	2.0
Peak Gain (dBi)	3.2	4.2	3.4
Average Gain (dBi)	-2.1	-2.4	-3.3
Efficiency (%)	65	62	51
Impedance	50 Ω		
Polarization	Linear		
Radiation	Omnidirectional		
Wavelength	1/4-wave		
Electrical Type	Monopole		
Max Power	5 W		

Electrical specifications and plots measured with a 150 mm x 90 mm (5.91 in x 3.54 in) reference ground plane, edge bent orientation.

Table 2. Mechanical Specifications

Parameter	Value
Connection	SMA plug (male pin) or RP-SMA plug (female socket)
Operating Temp. Range	-40 °C to +130 °C
Weight	8.4 g (0.30 oz)
Dimensions	71.1 mm x Ø9.3 mm (2.80 in x Ø0.37 in)

Product Dimensions

Figure 1 provides dimensions of the ANT-W63-MON-ccc antenna. The antenna whip can be tilted 90 degrees, and has a detent at 45 degrees enabling the antenna to be oriented in any direction. The rotating base allows for continuous positioning through 360 degrees even while installed.

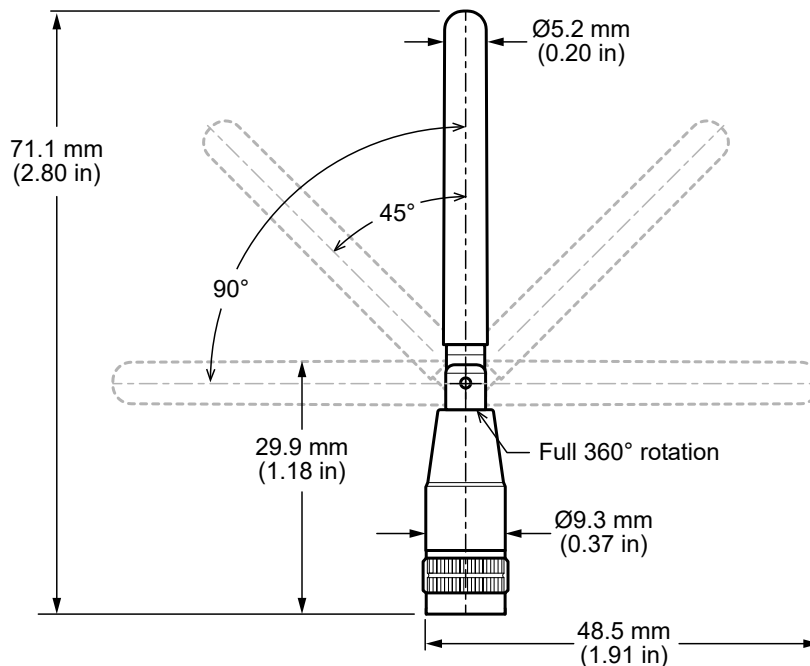

Figure 1. ANT-W63-MON-ccc Antenna Dimensions

**Ground Plane**

1/4-Wave monopole antennas require an associated ground plane counterpoise for best performance. The size and location of the ground plane relative to the antenna will affect the overall performance of the antenna in the final design. The proximity of other circuit elements and packaging near the antenna will also affect the final performance.

For further discussion and guidance on the importance of the ground plane counterpoise, please refer to Linx Application Note, AN-00501: *Understanding Antenna Specifications and Operation*.

**Antenna Orientation**

The ANT-W63-MON antenna is characterized in two antenna orientations as shown in Figure 2. The two orientations with the antenna on the edge of the ground plane bent 90 degrees and on the edge of the ground plane straight, represent the most common orientations in end-product use. Performance data is provided for installation on a 150 mm x 90 mm ground plane and on a 102 mm x 102 mm ground plane.

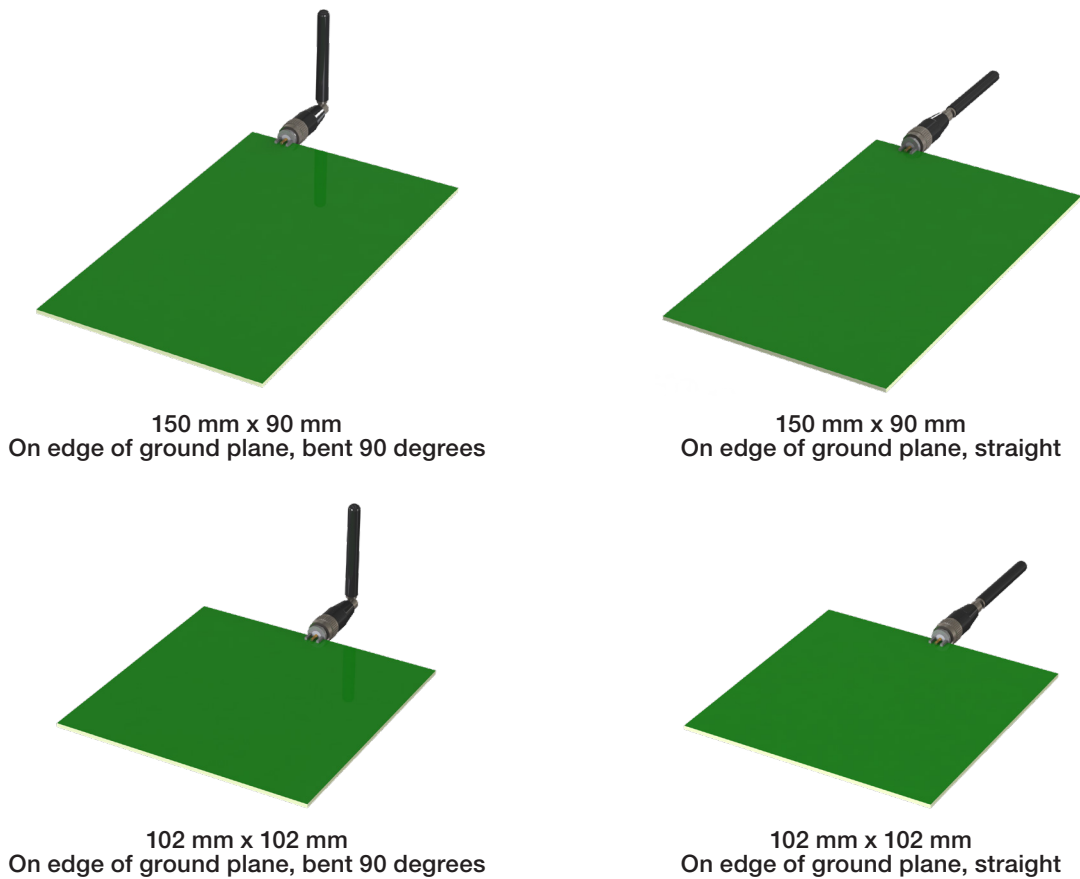

Figure 2. ANT-W63-MON-ccc Test Orientations

Edge of Ground Plane, Bent 90 Degrees (150 mm x 90 mm Ground Plane)

The charts on the following pages represent data taken with the antenna oriented at the edge of the ground plane, bent 90 degrees (Edge-Bent), as shown in Figure 3.

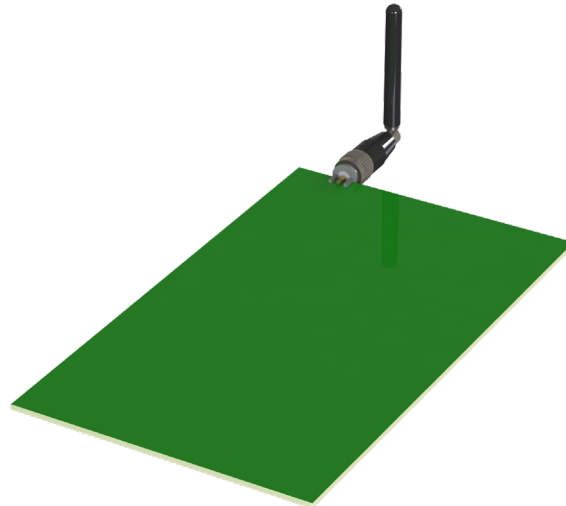

Figure 3. ANT-W63-MON-ccc on Edge of Ground Plane, Bent 90 Degrees (Edge-Bent)

VSWR

Figure 4 provides the voltage standing wave ratio (VSWR) across the antenna bandwidth. VSWR describes the power reflected from the antenna back to the radio. A lower VSWR value indicates better antenna performance at a given frequency. Reflected power is also shown on the right-side vertical axis as a gauge of the percentage of transmitter power reflected back from the antenna.

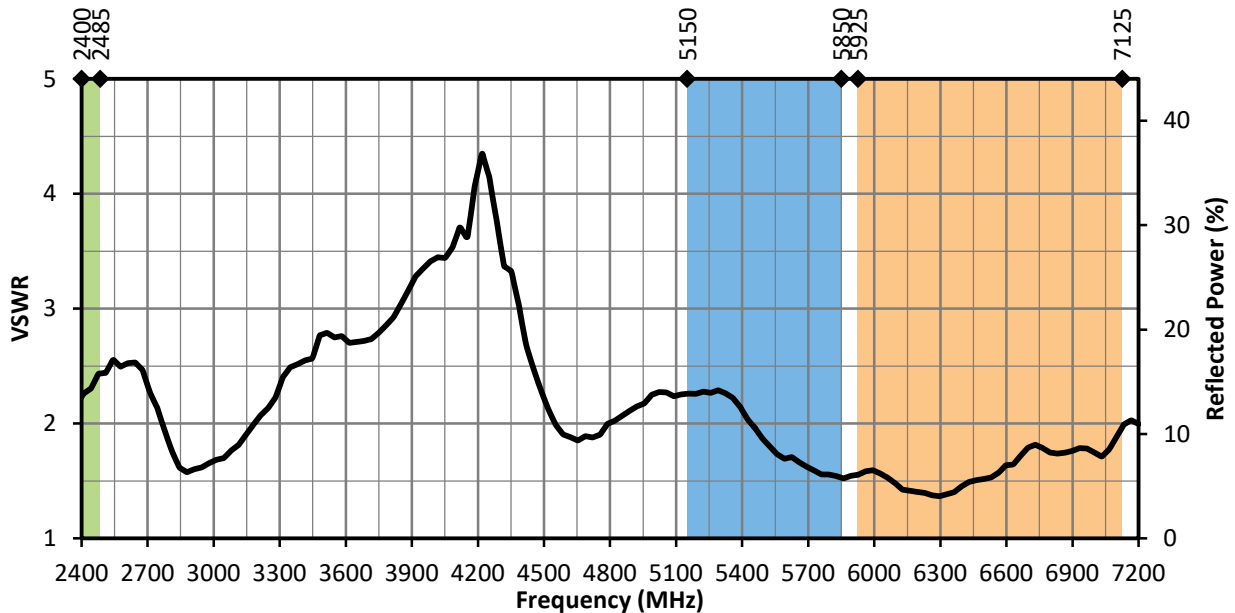

Figure 4. ANT-W63-MON VSWR, Edge-Bent

Return Loss

Return loss (Figure 5), represents the loss in power at the antenna due to reflected signals. Like VSWR, a lower return loss value indicates better antenna performance at a given frequency.

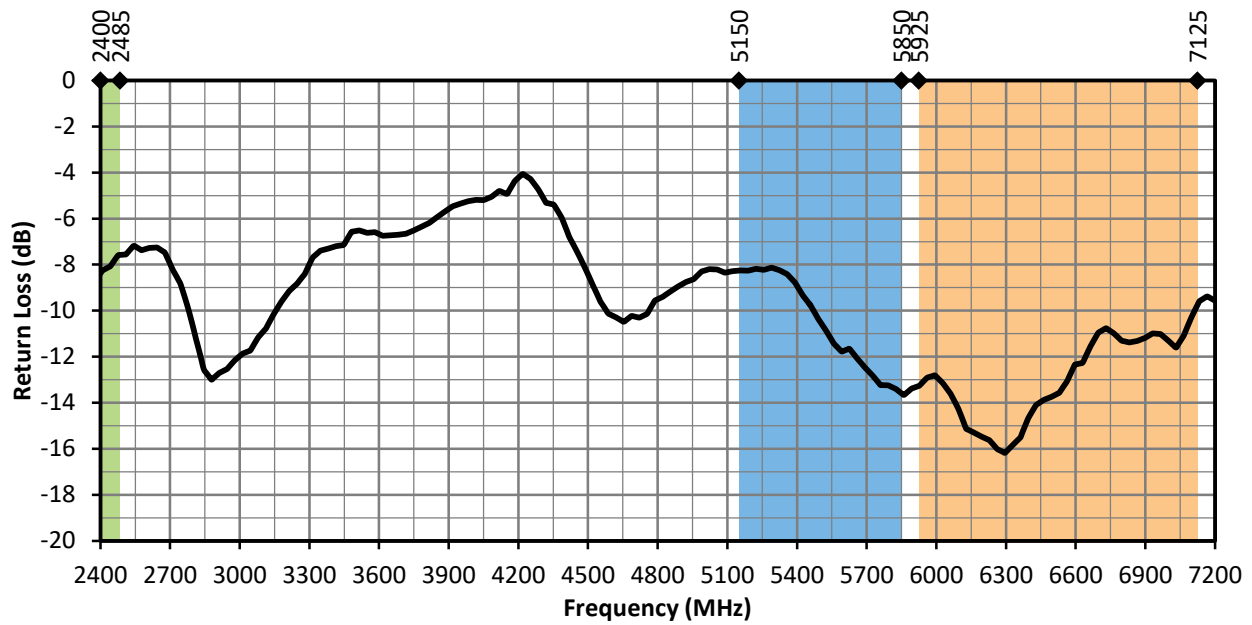

Figure 5. ANT-W63-MON Return Loss, Edge-Bent

Peak Gain

The peak gain across the antenna bandwidth is shown in Figure 6. Peak gain represents the maximum antenna input power concentration across 3-dimensional space, and therefore peak performance at a given frequency, but does not consider any directionality in the gain pattern.

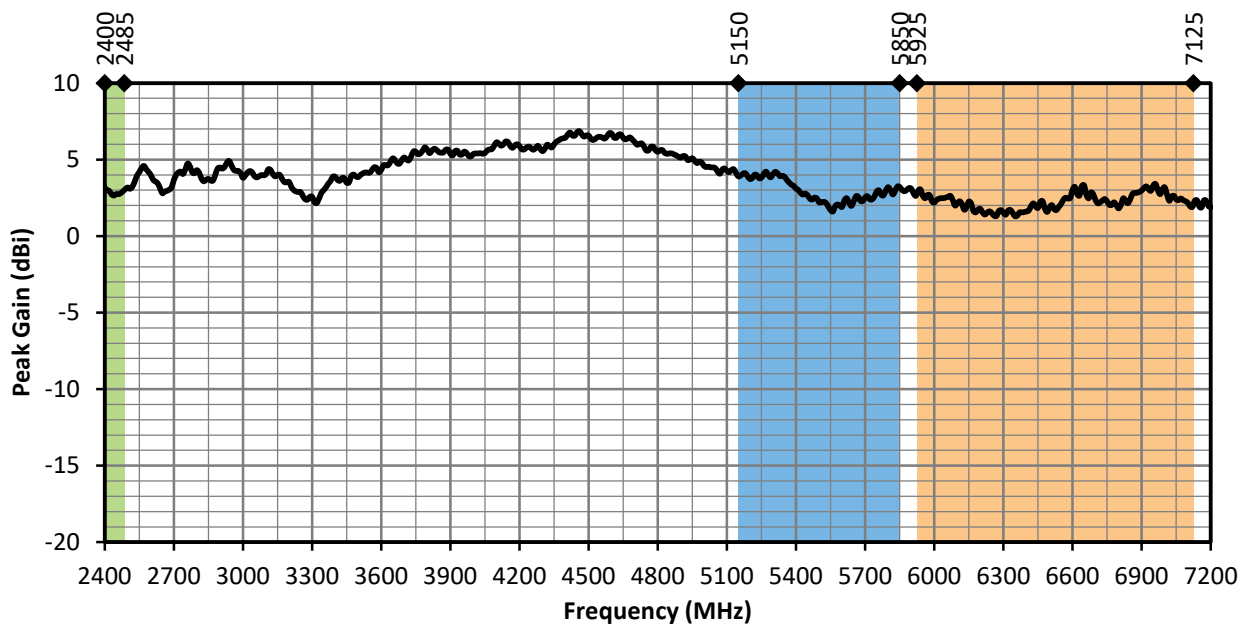

Figure 6. ANT-W63-MON Peak Gain, Edge-Bent

### Average Gain

Average gain (Figure 7), is the average of all antenna gain in 3-dimensional space at each frequency, providing an indication of overall performance without expressing antenna directionality.

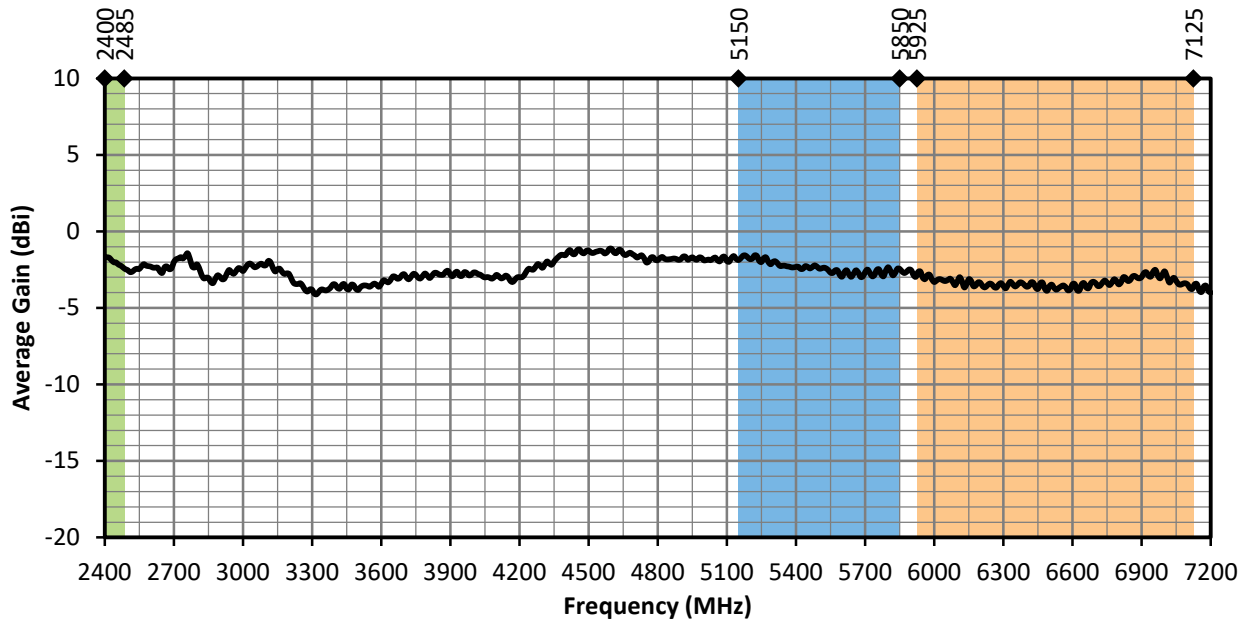

Figure 7. ANT-W63-MON Antenna Average Gain, Edge-Bent

### Radiation Efficiency

Radiation efficiency (Figure 8), shows the ratio of power delivered to the antenna relative to the power radiated at the antenna, expressed as a percentage, where a higher percentage indicates better performance at a given frequency.

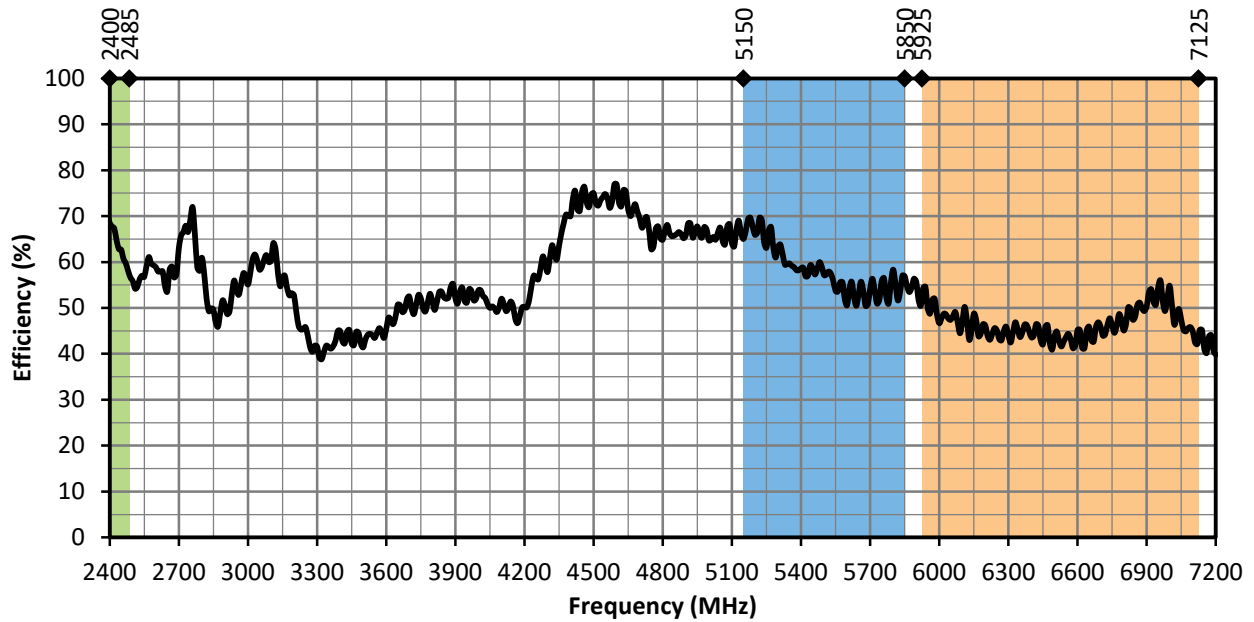

Figure 8. ANT-W63-MON Antenna Efficiency, Edge-Bent

Radiation Patterns

Radiation patterns provide information about the directionality and 3-dimensional gain performance of the antenna by plotting gain at specific frequencies in three orthogonal planes. Antenna radiation patterns for an Edge-Bent orientation are shown in Figure 9 using polar plots covering 360 degrees. The antenna graphic at the top of the page provides reference to the plane of the column of plots below it. Note: when viewed with typical PDF viewing software, zooming into radiation patterns is possible to reveal fine detail.

Radiation Patterns - Edge-Bent



XZ-Plane Gain



YZ-Plane Gain

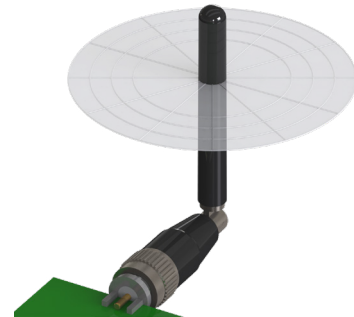

XY-Plane Gain

2400 MHz to 2485 MHz (2450 MHz)

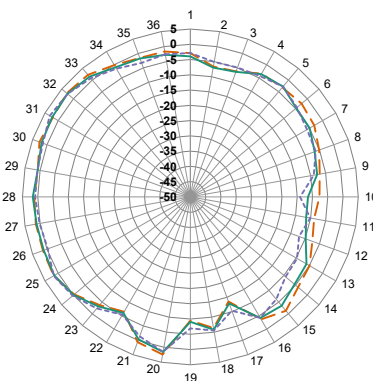

XZ-Plane Gain

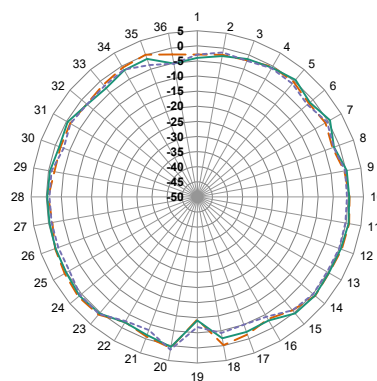

YZ-Plane Gain

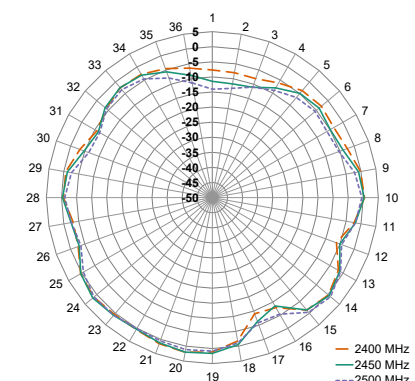

XY-Plane Gain

— 2400 MHz  
— 2450 MHz  
- - 2500 MHz

5150 MHz to 5850 MHz (5500 MHz)

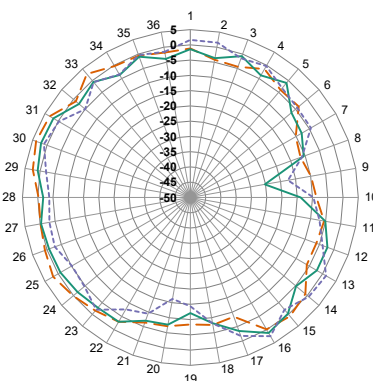

XZ-Plane Gain

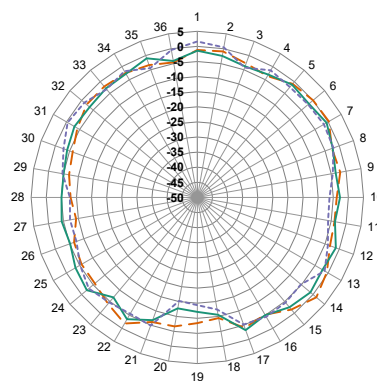

YZ-Plane Gain

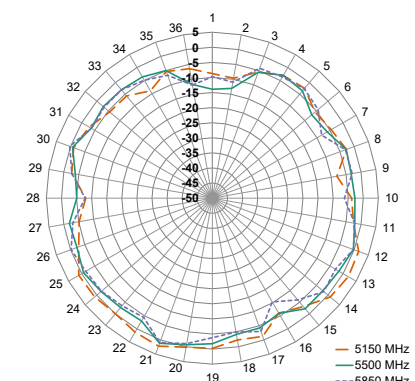

XY-Plane Gain

— 5150 MHz  
— 5500 MHz  
- - 5850 MHz

Radiation Patterns - Edge-Bent

5925 MHz to 7125 MHz (6500 MHz)

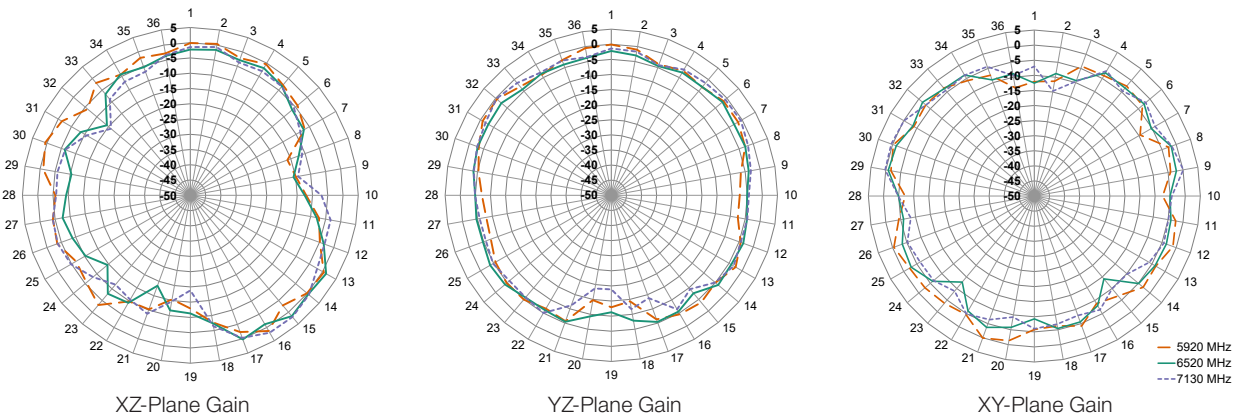

Figure 9. Radiation Patterns for ANT-W63-MON-ccc, Edge-Bent



Straight, Edge of Ground Plane (150 mm x 90 mm Ground Plane)

The charts on the following pages represent data taken with the antenna oriented straight, as shown in Figure 10.



Figure 10. ANT-W63-MON-ccc Straight, Edge of Ground Plane (Straight)

VSWR

Figure 11 provides the voltage standing wave ratio (VSWR) across the antenna bandwidth. VSWR describes the power reflected from the antenna back to the radio. A lower VSWR value indicates better antenna performance at a given frequency. Reflected power is also shown on the right-side vertical axis as a gauge of the percentage of transmitter power reflected back from the antenna.

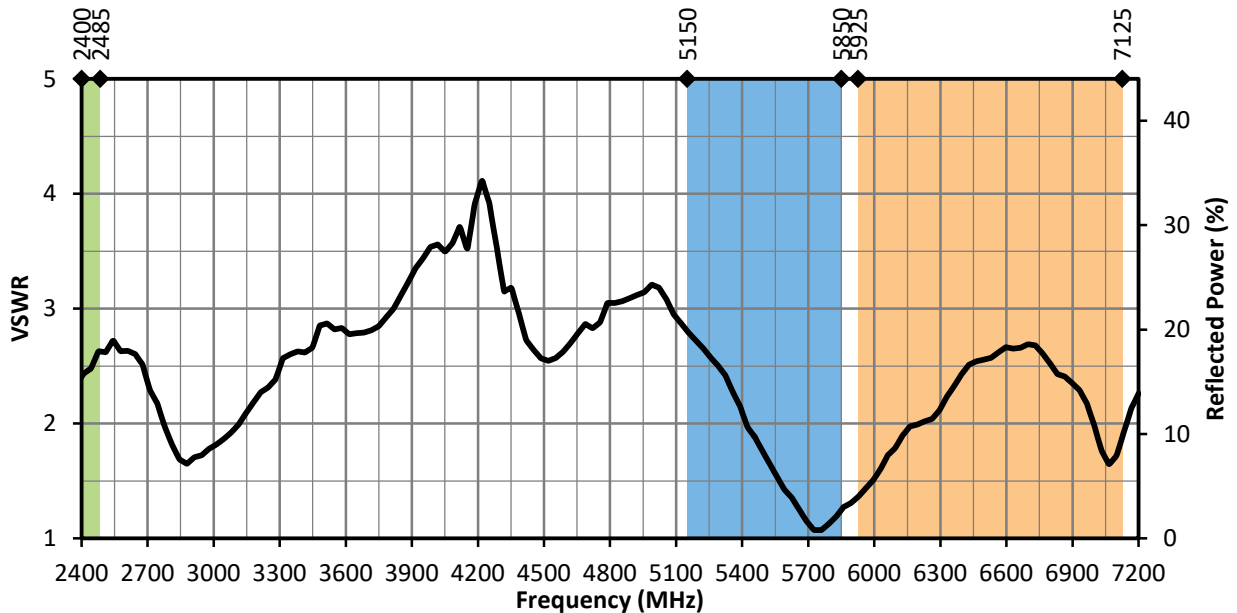

Figure 11. ANT-W63-MON VSWR, Straight

### Return Loss

Return loss (Figure 12), represents the loss in power at the antenna due to reflected signals. Like VSWR, a lower return loss value indicates better antenna performance at a given frequency.

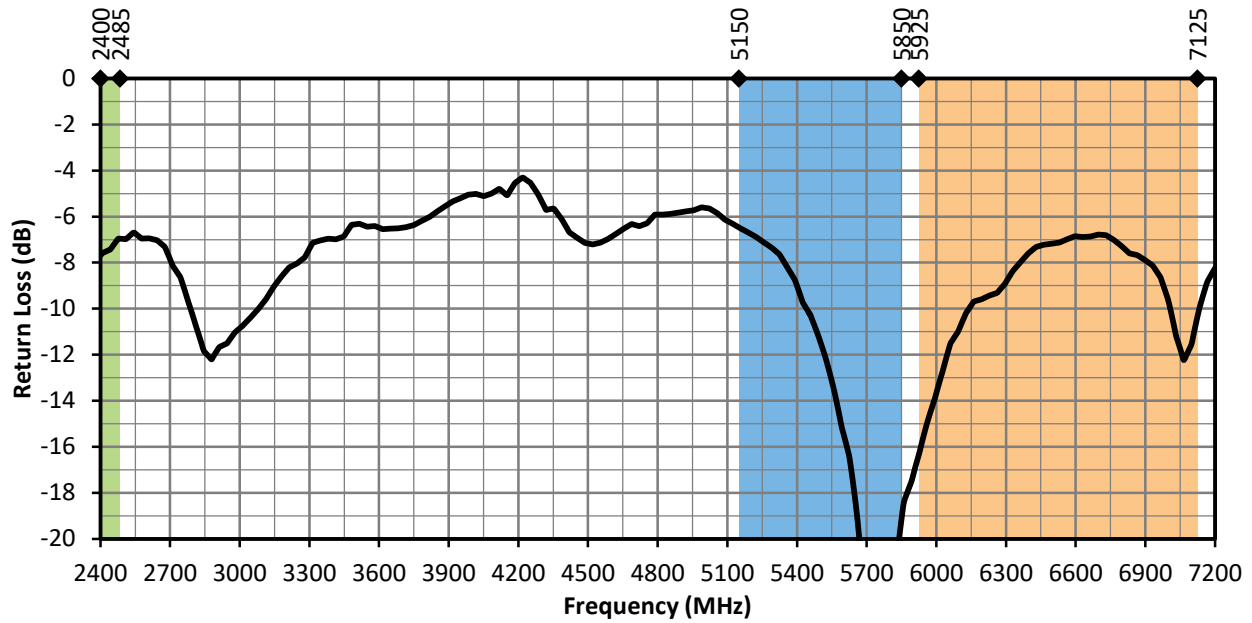

Figure 12. ANT-W63-MON Return Loss, Straight

### Peak Gain

The peak gain across the antenna bandwidth is shown in Figure 13. Peak gain represents the maximum antenna input power concentration across 3-dimensional space, and therefore peak performance at a given frequency, but does not consider any directionality in the gain pattern.

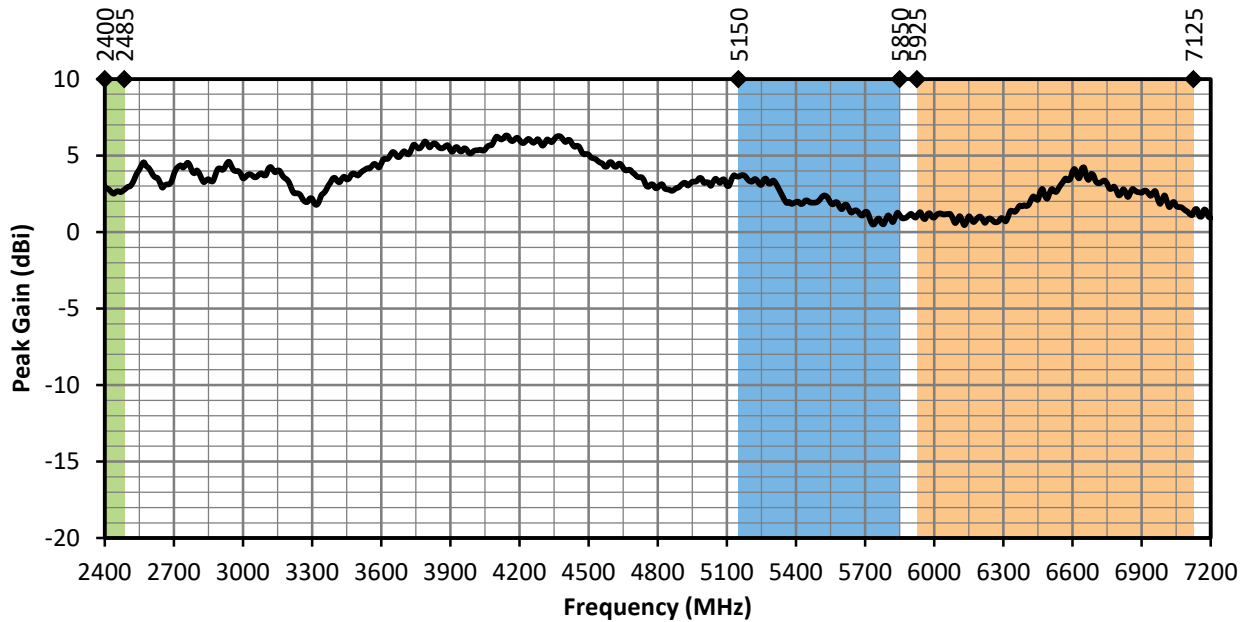

Figure 13. ANT-W63-MON Peak Gain, Straight

### Average Gain

Average gain (Figure 14), is the average of all antenna gain in 3-dimensional space at each frequency, providing an indication of overall performance without expressing antenna directionality.

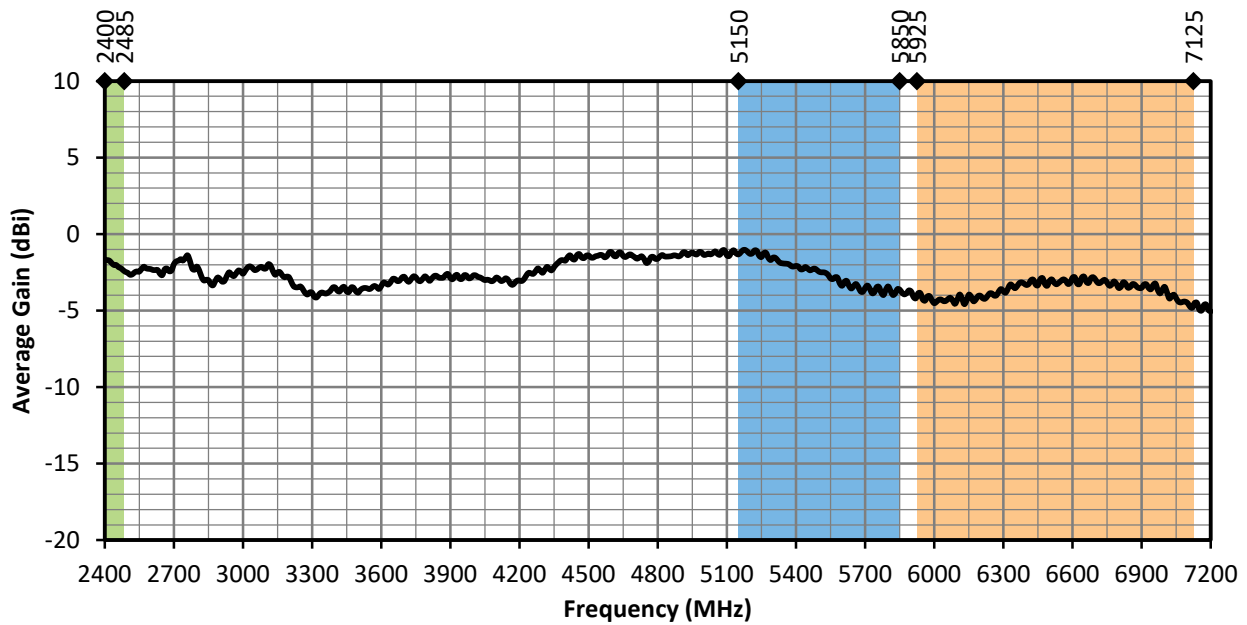

Figure 14. ANT-W63-MON Antenna Average Gain, Straight

### Radiation Efficiency

Radiation efficiency (Figure 15), shows the ratio of power delivered to the antenna relative to the power radiated at the antenna, expressed as a percentage, where a higher percentage indicates better performance at a given frequency.

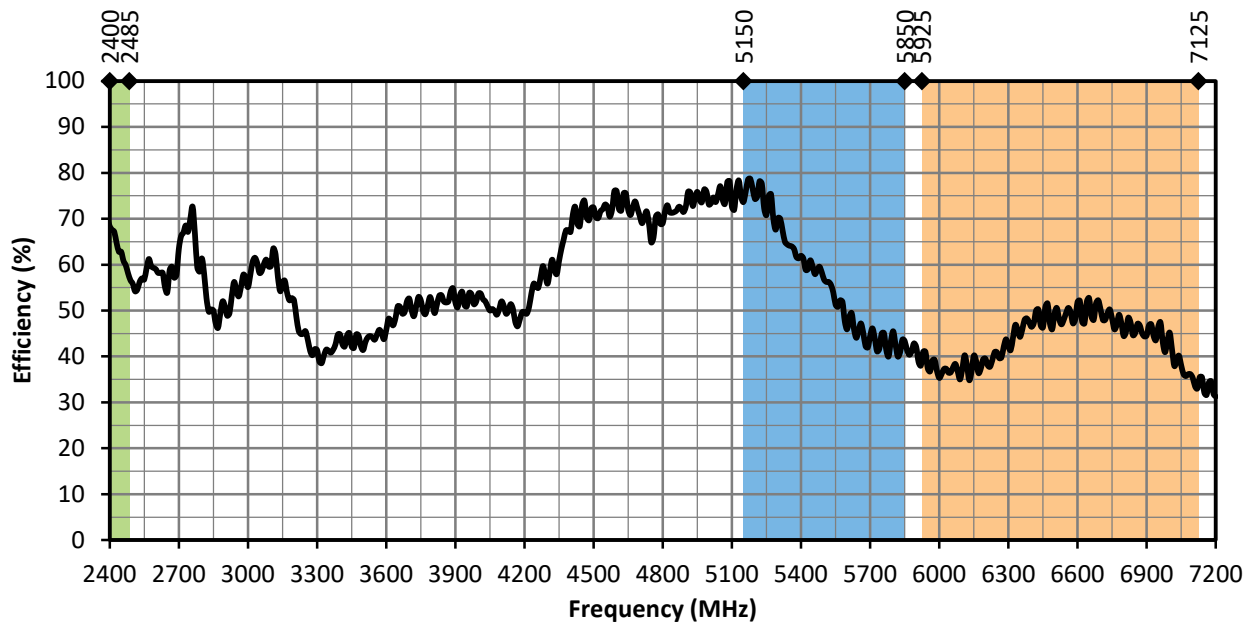
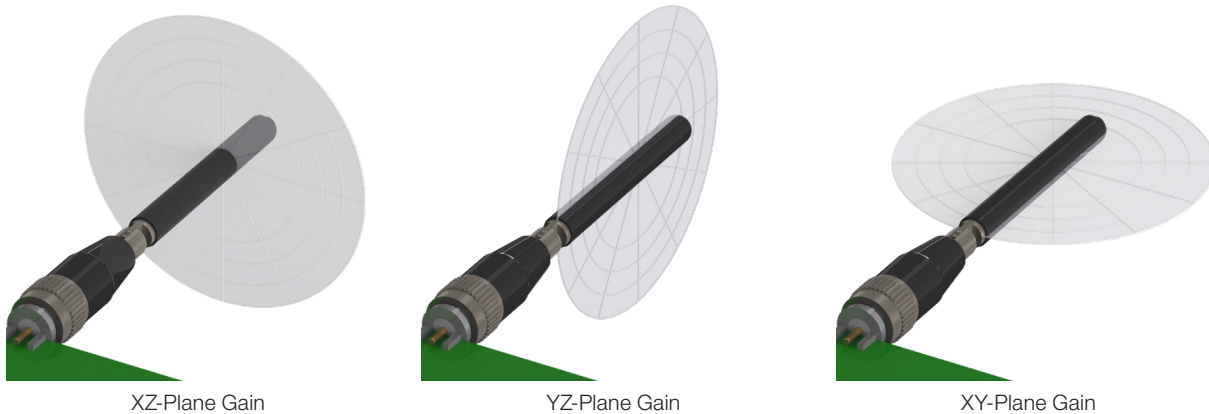

Figure 15. ANT-W63-MON Antenna Efficiency, Straight

Radiation Patterns

Radiation patterns provide information about the directionality and 3-dimensional gain performance of the antenna by plotting gain at specific frequencies in three orthogonal planes. Antenna radiation patterns for an edge straight orientation are shown in Figure 16 using polar plots covering 360 degrees. The antenna graphic at the top of the page provides reference to the plane of the column of plots below it. Note: when viewed with typical PDF viewing software, zooming into radiation patterns is possible to reveal fine detail.

Radiation Patterns - Straight



2400 MHz to 2485 MHz (2450 MHz)

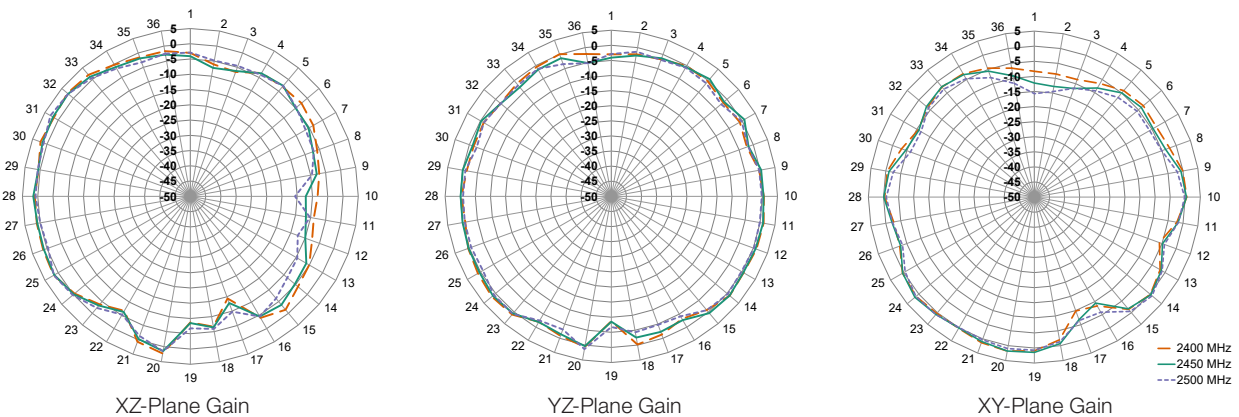

5150 MHz to 5850 MHz (5500 MHz)

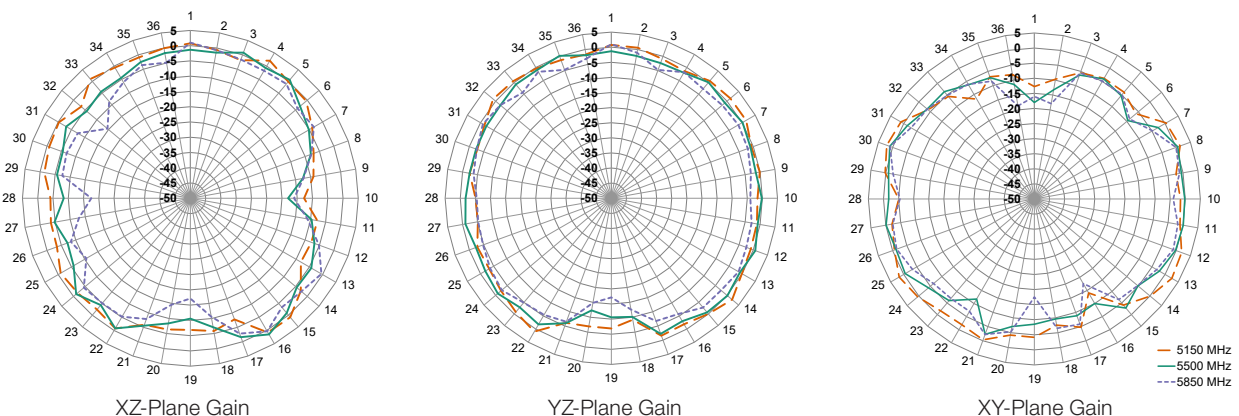

Radiation Patterns - Straight  
5925 MHz to 7125 MHz (6500 MHz)

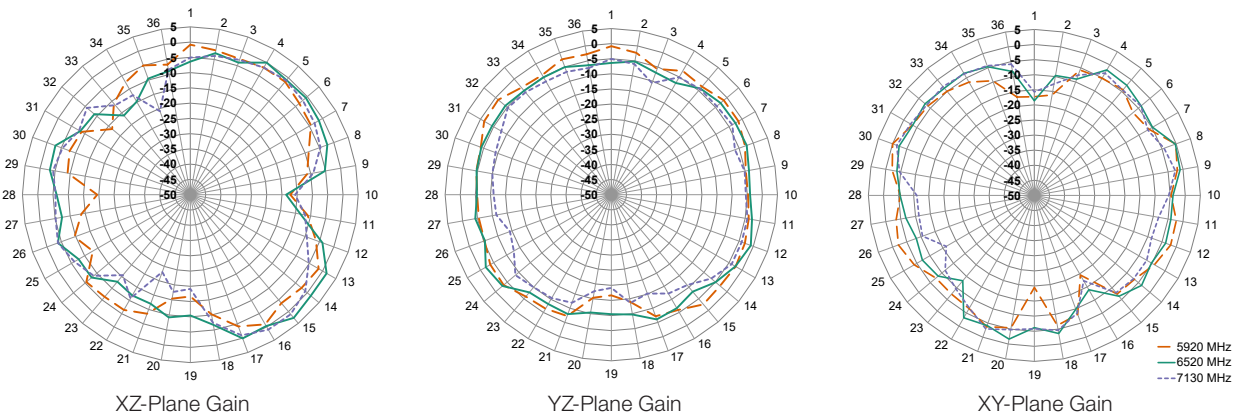

Figure 16. Radiation Patterns for ANT-W63-MON-ccc, Straight

Edge of Ground Plane, Bent 90 Degrees (102 mm x 102 mm Ground Plane)

The charts on the following pages represent data taken with the antenna oriented at the edge of the ground plane, bent 90 degrees (Edge-Bent), as shown in Figure 17.



Figure 17. ANT-W63-MON-ccc on Edge of Ground Plane, Bent 90 Degrees (Edge-Bent)

VSWR

Figure 18 provides the voltage standing wave ratio (VSWR) across the antenna bandwidth. VSWR describes the power reflected from the antenna back to the radio. A lower VSWR value indicates better antenna performance at a given frequency. Reflected power is also shown on the right-side vertical axis as a gauge of the percentage of transmitter power reflected back from the antenna.

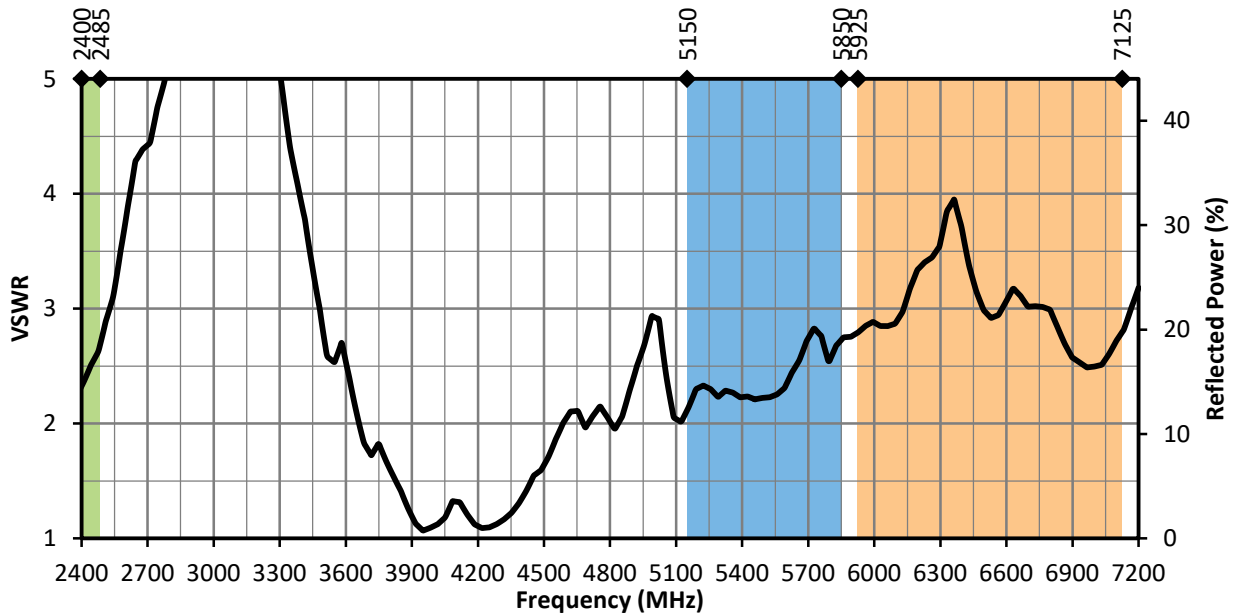

Figure 18. ANT-W63-MON VSWR, Edge-Bent

Return Loss

Return loss (Figure 19), represents the loss in power at the antenna due to reflected signals. Like VSWR, a lower return loss value indicates better antenna performance at a given frequency.

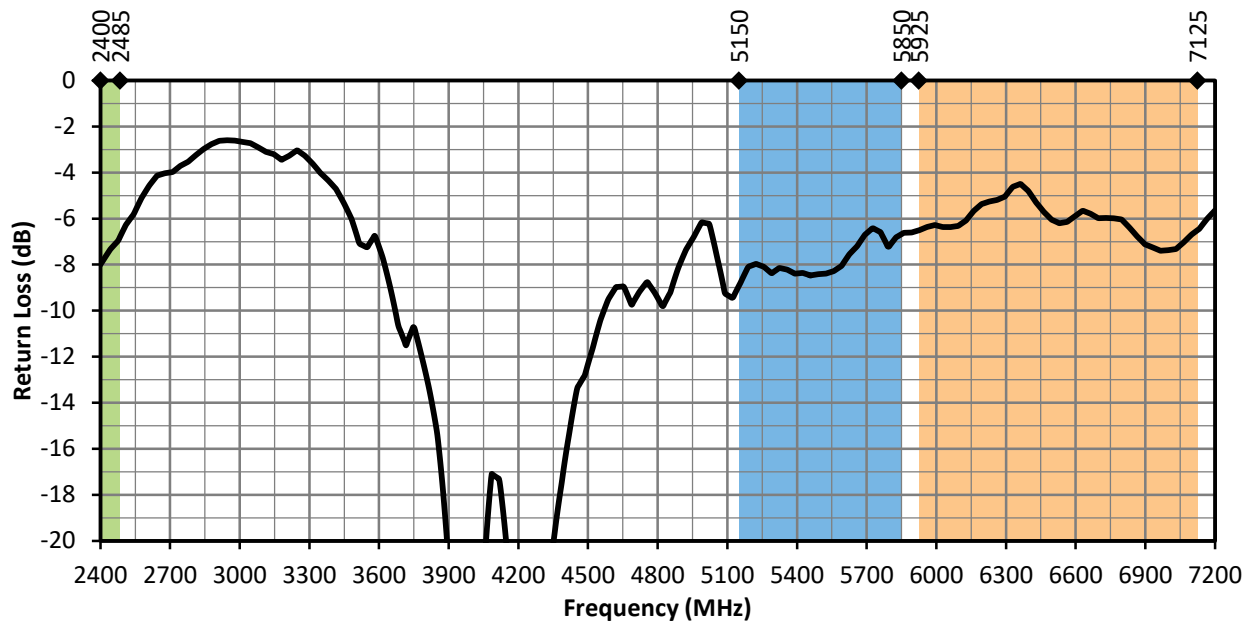

Figure 19. ANT-W63-MON Return Loss, Edge-Bent

Peak Gain

The peak gain across the antenna bandwidth is shown in Figure 20. Peak gain represents the maximum antenna input power concentration across 3-dimensional space, and therefore peak performance at a given frequency, but does not consider any directionality in the gain pattern.

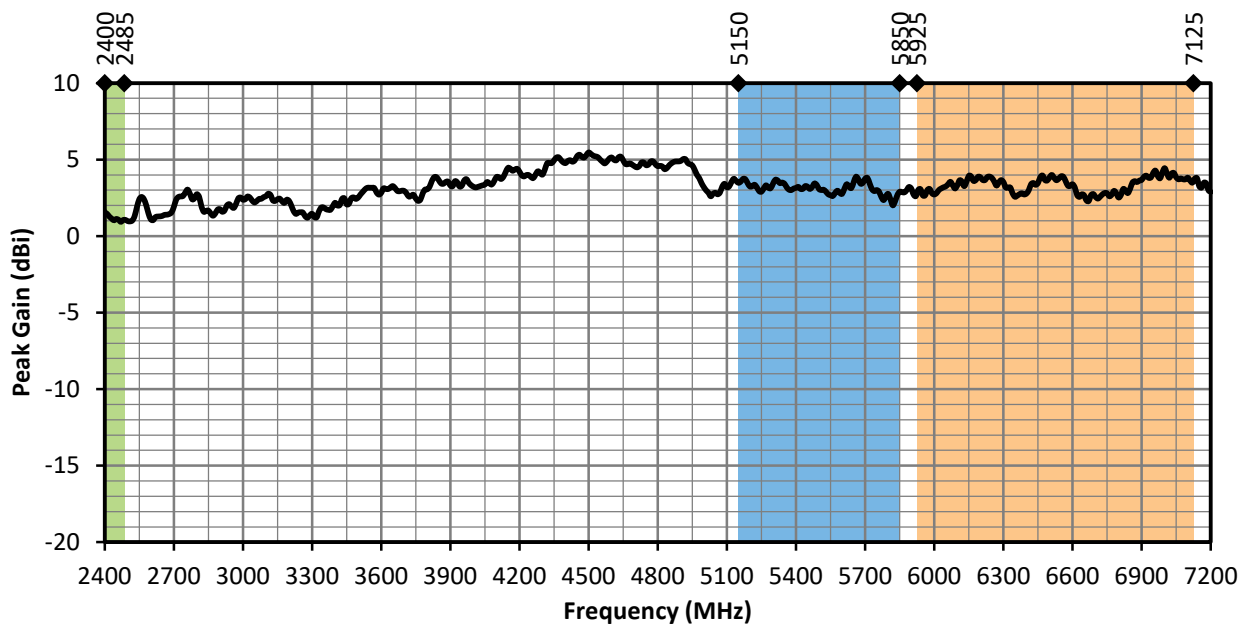

Figure 20. ANT-W63-MON Peak Gain, Edge-Bent

### Average Gain

Average gain (Figure 21), is the average of all antenna gain in 3-dimensional space at each frequency, providing an indication of overall performance without expressing antenna directionality.

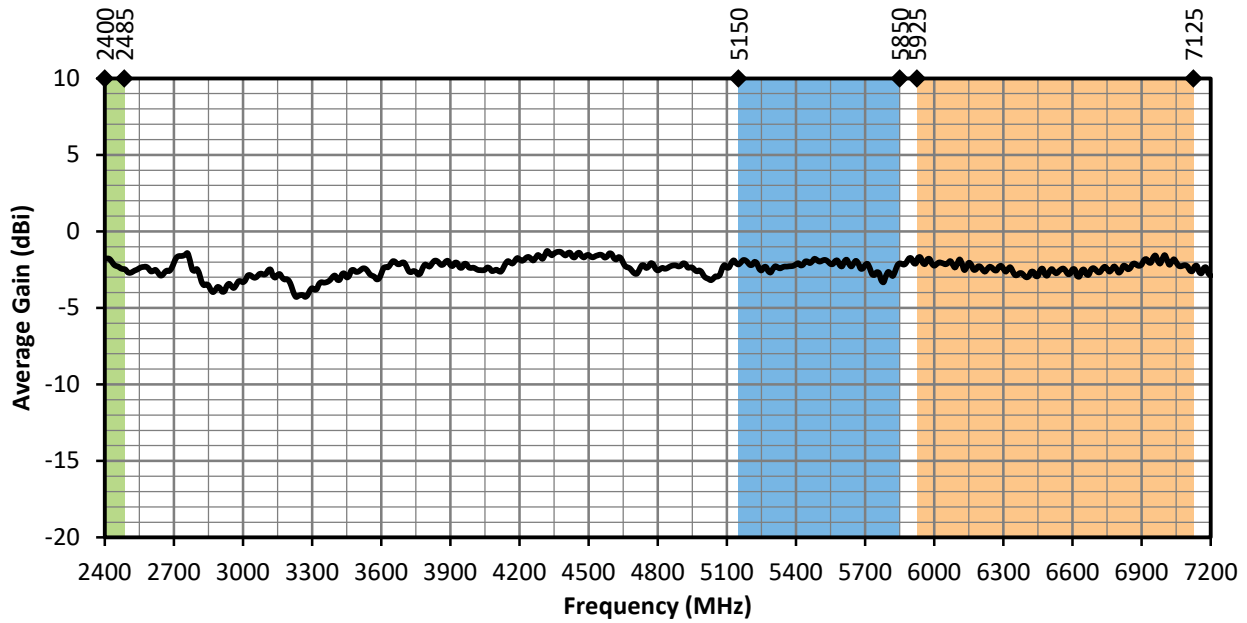

Figure 21. ANT-W63-MON Antenna Average Gain, Edge-Bent

### Radiation Efficiency

Radiation efficiency (Figure 22), shows the ratio of power delivered to the antenna relative to the power radiated at the antenna, expressed as a percentage, where a higher percentage indicates better performance at a given frequency.

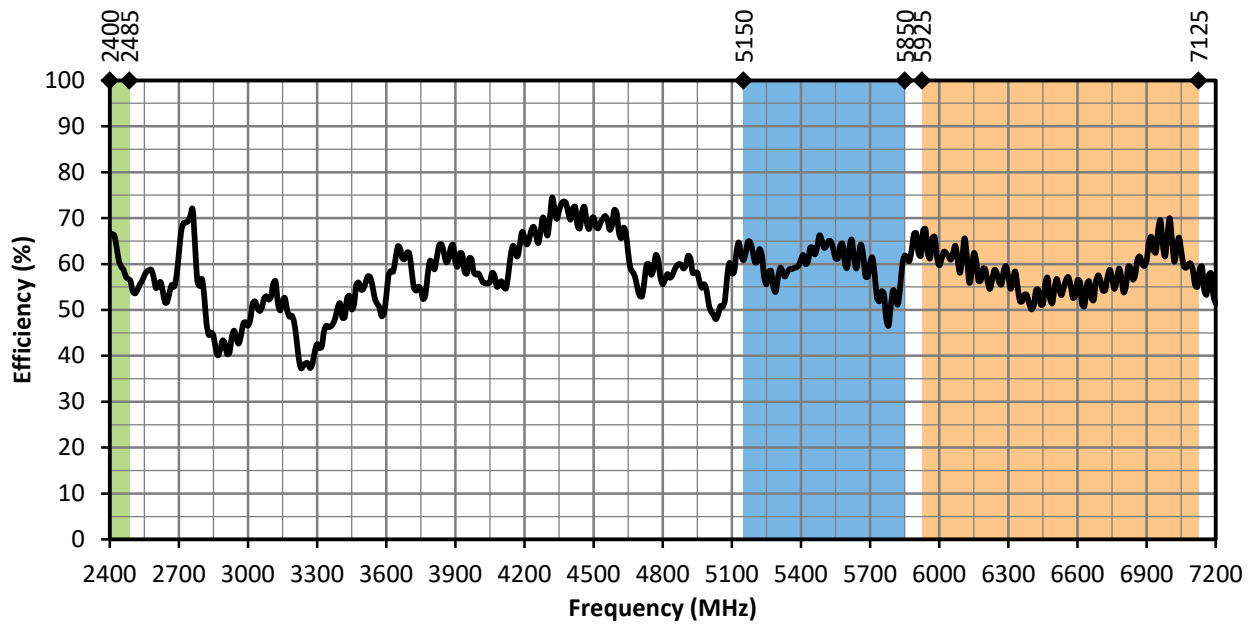

Figure 22. ANT-W63-MON Antenna Efficiency, Edge-Bent



### Radiation Patterns

Radiation patterns provide information about the directionality and 3-dimensional gain performance of the antenna by plotting gain at specific frequencies in three orthogonal planes. Antenna radiation patterns for an Edge-Bent orientation are shown in Figure 9 using polar plots covering 360 degrees. The antenna graphic at the top of the page provides reference to the plane of the column of plots below it. Note: when viewed with typical PDF viewing software, zooming into radiation patterns is possible to reveal fine detail.

### Radiation Patterns - Edge-Bent



XZ-Plane Gain



YZ-Plane Gain

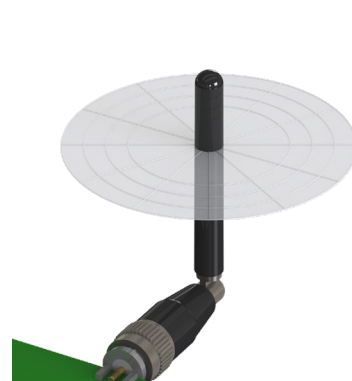

XY-Plane Gain

### 2400 MHz to 2485 MHz (2450 MHz)

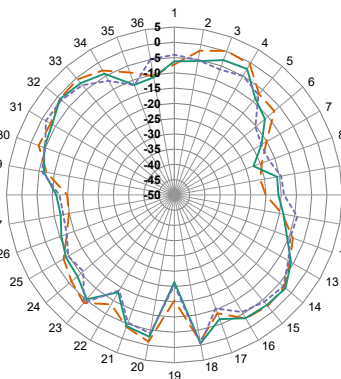

XZ-Plane Gain

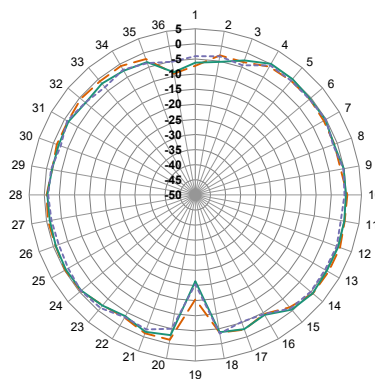

YZ-Plane Gain

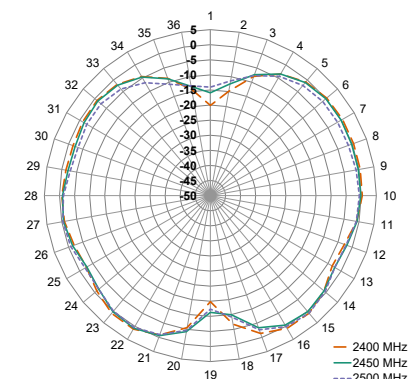

XY-Plane Gain

### 5150 MHz to 5850 MHz (5500 MHz)

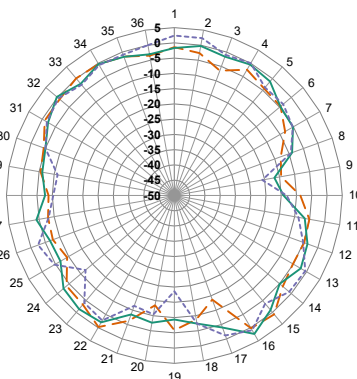

XZ-Plane Gain

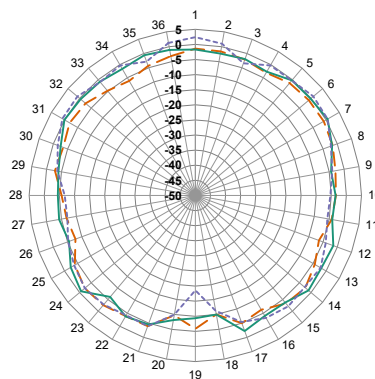

YZ-Plane Gain

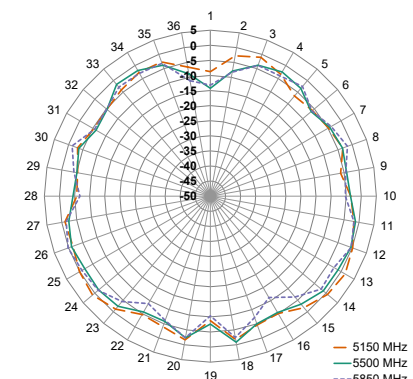

XY-Plane Gain

Radiation Patterns - Edge-Bent

5925 MHz to 7125 MHz (6500 MHz)

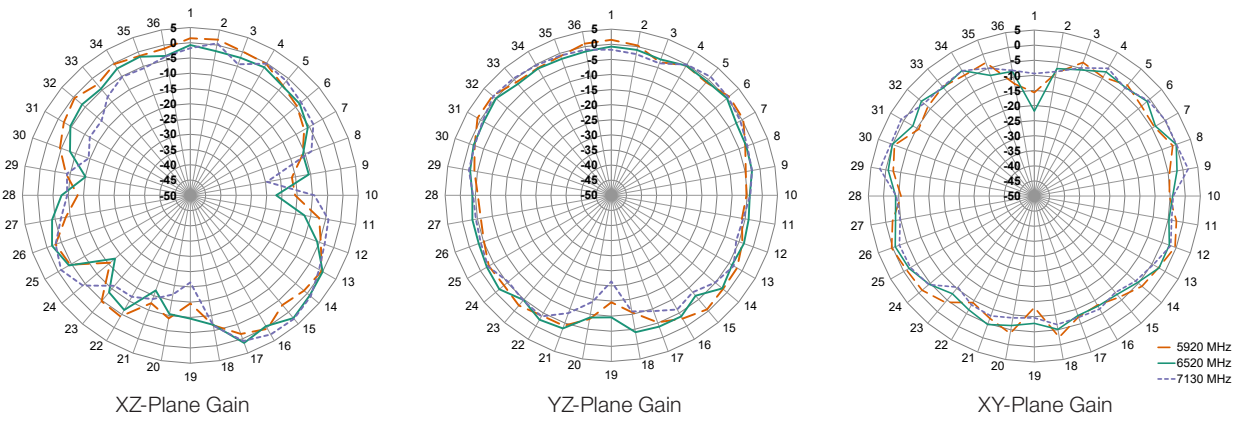

Figure 23. Radiation Patterns for ANT-W63-MON-ccc, Edge-Bent

Straight, Edge of Ground Plane (102 mm x 102 mm Ground Plane)

The charts on the following pages represent data taken with the antenna oriented straight, as shown in Figure 24.

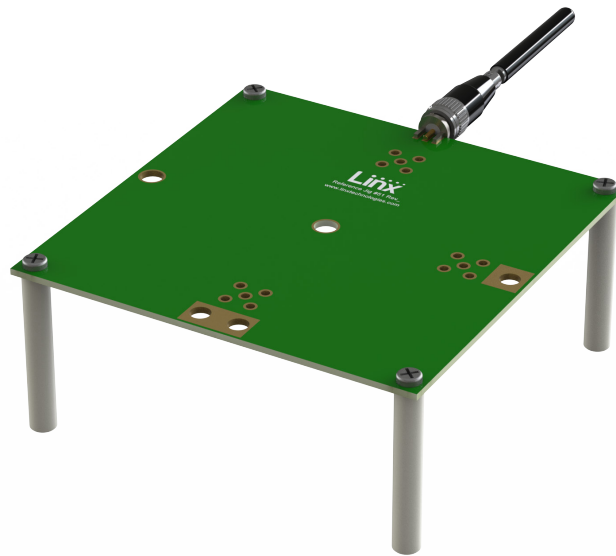

Figure 24. ANT-W63-MON-ccc Straight, Edge of Ground Plane (Straight)

VSWR

Figure 25 provides the voltage standing wave ratio (VSWR) across the antenna bandwidth. VSWR describes the power reflected from the antenna back to the radio. A lower VSWR value indicates better antenna performance at a given frequency. Reflected power is also shown on the right-side vertical axis as a gauge of the percentage of transmitter power reflected back from the antenna.

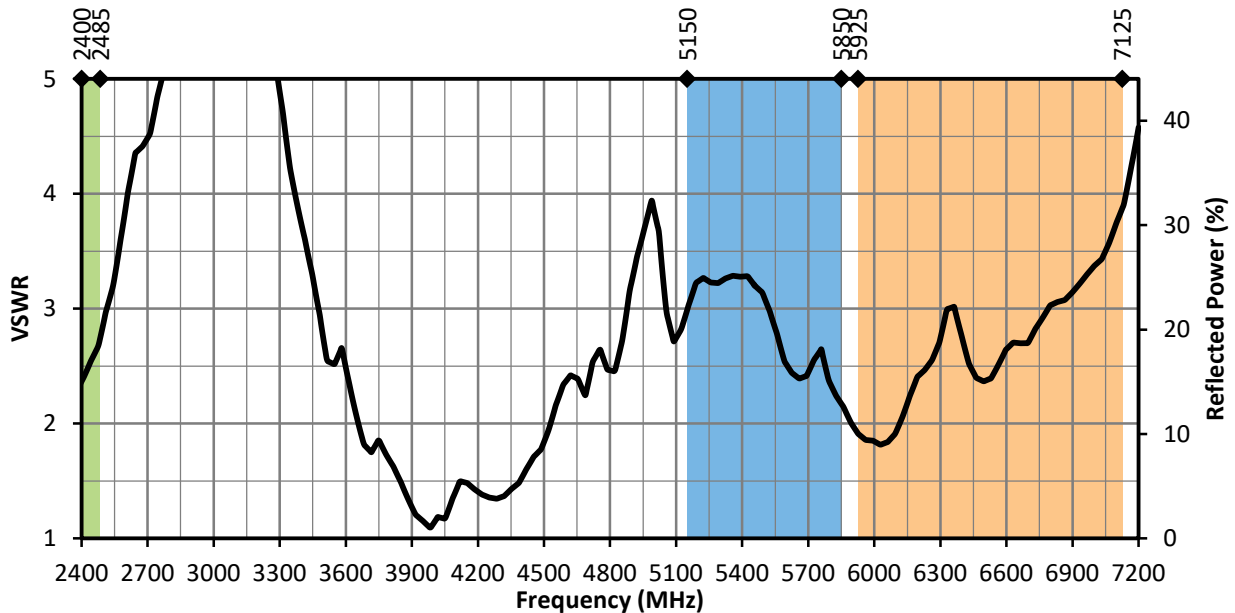

Figure 25. ANT-W63-MON VSWR, Straight

### Return Loss

Return loss (Figure 26), represents the loss in power at the antenna due to reflected signals. Like VSWR, a lower return loss value indicates better antenna performance at a given frequency.

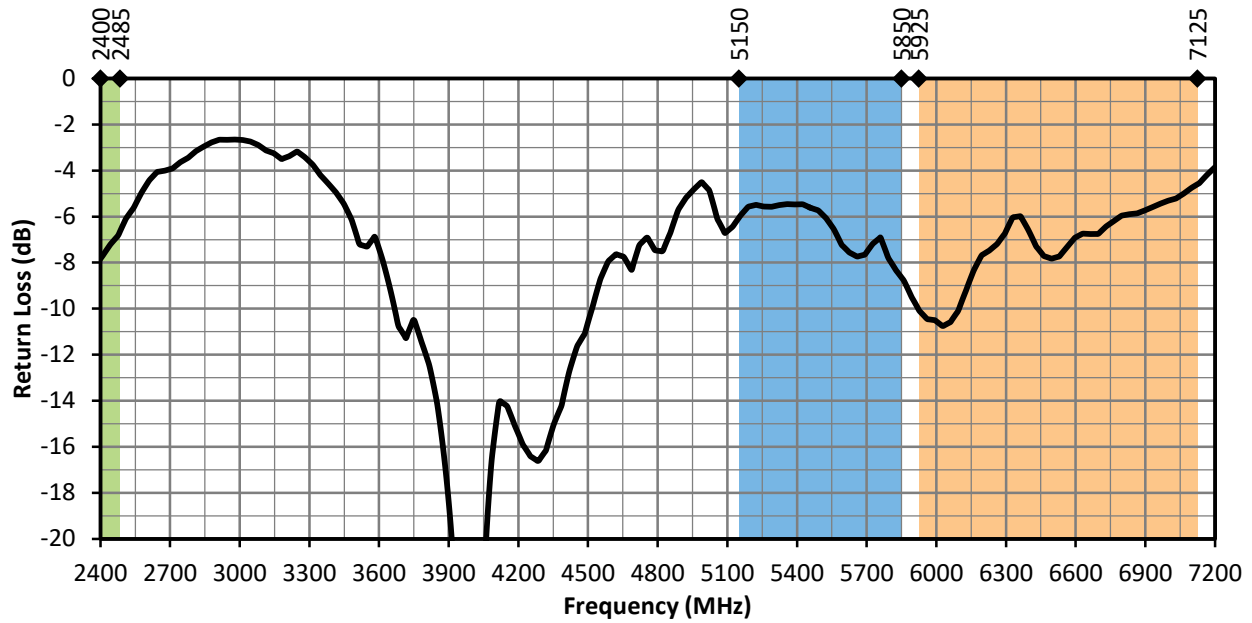

Figure 26. ANT-W63-MON Return Loss, Straight

### Peak Gain

The peak gain across the antenna bandwidth is shown in Figure 27. Peak gain represents the maximum antenna input power concentration across 3-dimensional space, and therefore peak performance at a given frequency, but does not consider any directionality in the gain pattern.

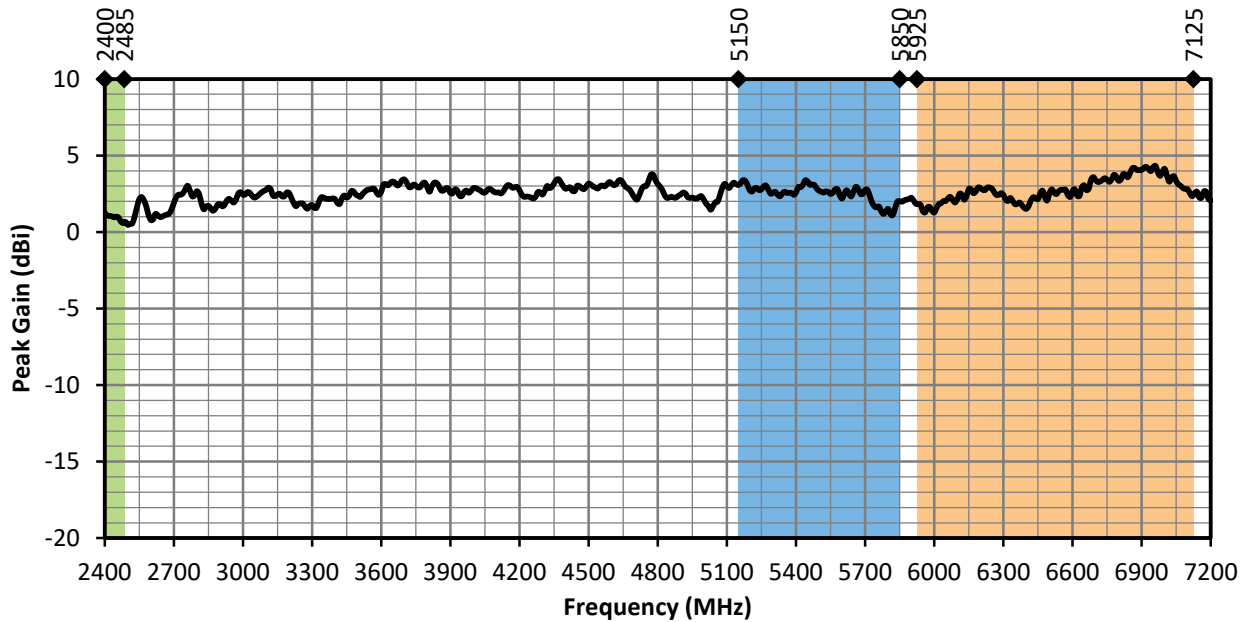

Figure 27. ANT-W63-MON Peak Gain, Straight

### Average Gain

Average gain (Figure 28), is the average of all antenna gain in 3-dimensional space at each frequency, providing an indication of overall performance without expressing antenna directionality.

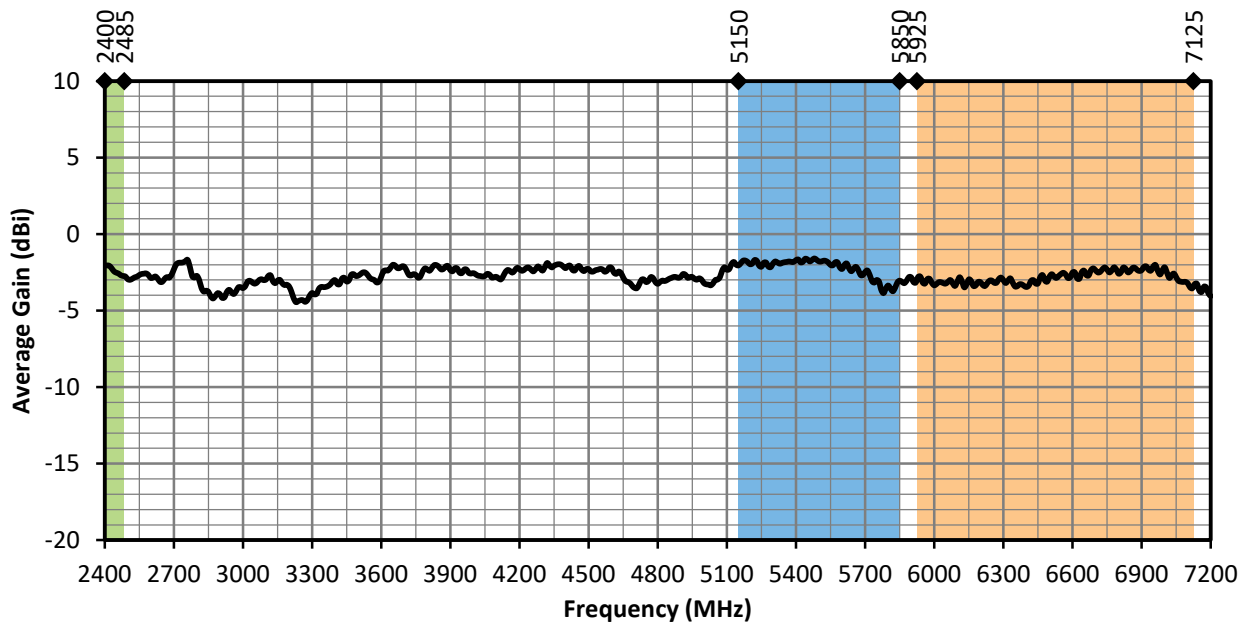

Figure 28. ANT-W63-MON Antenna Average Gain, Straight

### Radiation Efficiency

Radiation efficiency (Figure 29), shows the ratio of power delivered to the antenna relative to the power radiated at the antenna, expressed as a percentage, where a higher percentage indicates better performance at a given frequency.

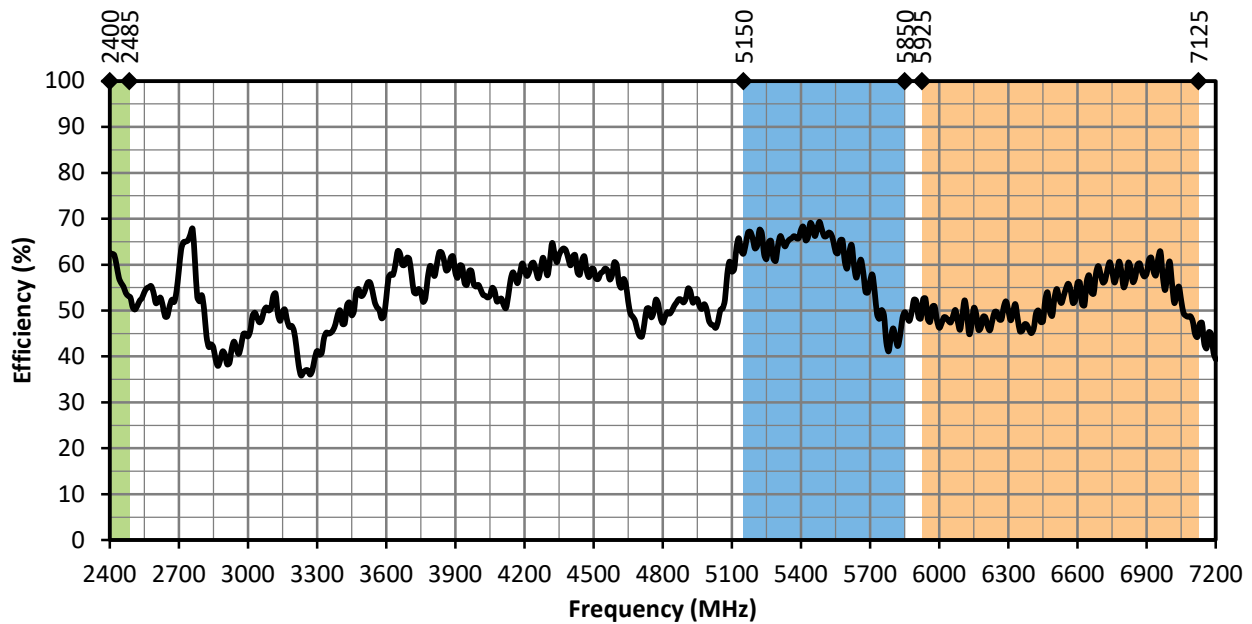
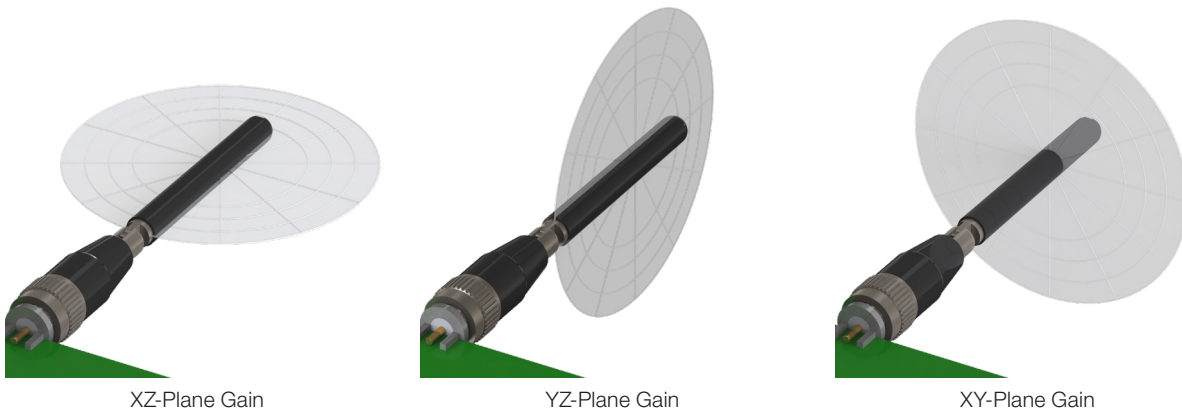

Figure 29. ANT-W63-MON Antenna Efficiency, Straight

### Radiation Patterns

Radiation patterns provide information about the directionality and 3-dimensional gain performance of the antenna by plotting gain at specific frequencies in three orthogonal planes. Antenna radiation patterns for an edge straight orientation are shown in Figure 30 using polar plots covering 360 degrees. The antenna graphic at the top of the page provides reference to the plane of the column of plots below it. Note: when viewed with typical PDF viewing software, zooming into radiation patterns is possible to reveal fine detail.

### Radiation Patterns - Straight



### 2400 MHz to 2485 MHz (2450 MHz)

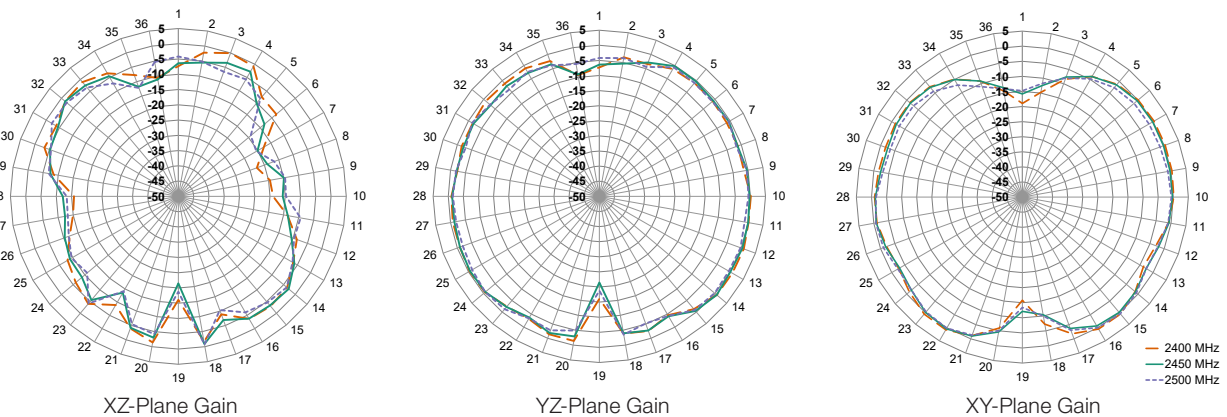

### 5150 MHz to 5850 MHz (5500 MHz)

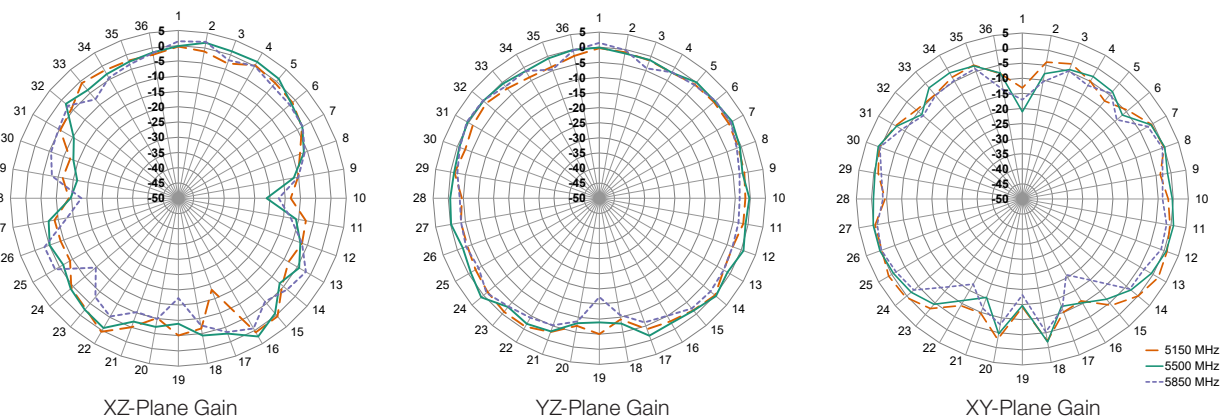

Radiation Patterns - Straight  
5925 MHz to 7125 MHz (6500 MHz)

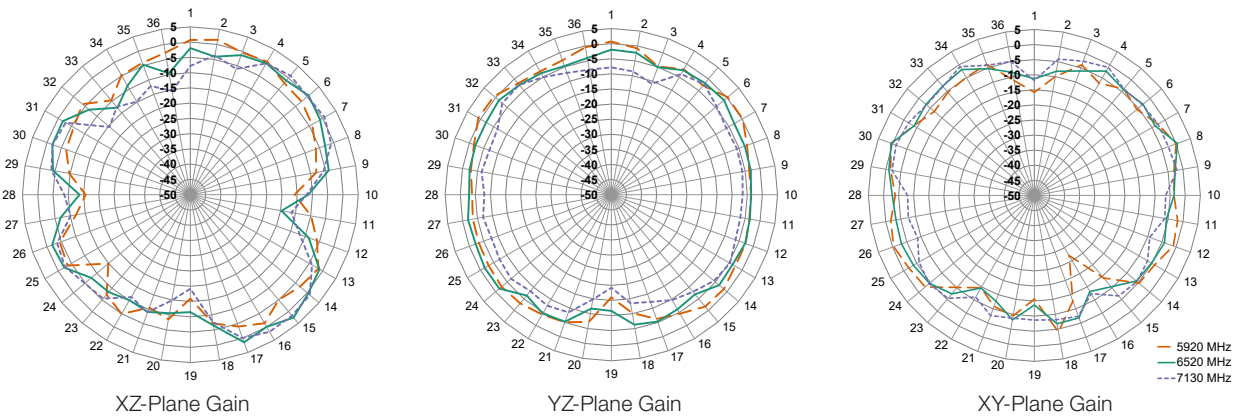

Figure 30. Radiation Patterns for ANT-W63-MON-ccc, Straight

---

**Website:** <http://linxtechnologies.com>  
**Linx Offices:** 159 Ort Lane, Merlin, OR, US 97532  
**Phone:** +1 (541) 471-6256  
**E-MAIL:** [info@linxtechnologies.com](mailto:info@linxtechnologies.com)

---

Linx Technologies reserves the right to make changes to the product(s) or information contained herein without notice. No liability is assumed as a result of their use or application. No rights under any patent accompany the sale of any such product(s) or information.

Wireless Made Simple is a registered trademark of Linx Acquisitions LLC. Bluetooth is a registered trademark of Bluetooth SIG, Inc. ZigBee is a registered trademark of ZigBee Alliance, Inc. Other product and brand names may be trademarks or registered trademarks of their respective owners.

Copyright © 2022 Linx Technologies

All Rights Reserved

Doc# DS22010-172ANT Replaces (DS21243-172ANT)

