

Features:

- Very High Power Density: 21.18W/in³
- U-Channel & Enclosed versions available
- Medical and I.T.E Approvals
- Small 2" x 3" Package
- Efficiencies up to 92%
- Suitable for BF Applied Part Applications
- Meets DoE Level VI Requirements
- No Load Power Consumption <150 mW
- Wide Operating Temperature Range from -20°C to +70°C¹

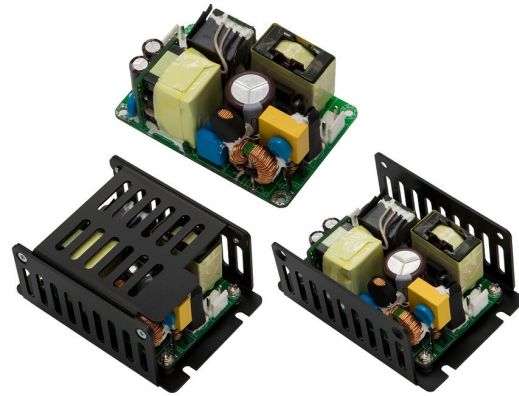

Description:

The PPWAM150 series of single output AC/DC converters is designed for use in both medical and industrial applications. Available in eight different standard output voltages spanning most of the SELV range, this power dense 2"x3" platform offers up to 150W of continuous throughput whilst maintaining Class B emissions compliance and DoE Level VI efficiency. Open frame, U-Channel, and enclosed versions are available.

Model Number ³	Output Voltage	Maximum Load with Convection Cooling	Maximum Load with 10CFM Forced Air	Ripple & Noise (Vp-p) ⁴	Output Regulation	Total Power (Convection)	Total Power (Forced Air)
PPWAM150-12A	12V	8.34A	12.5A	120mV	±3%	100W	150W
PPWAM150-13A	15V	6.67A	10.0A	240mV	±3%	100W	150W
PPWAM150-13-1A	18V	5.56A	8.34A	240mV	±3%	100W	150W
PPWAM150-14A	24V	4.17A	6.25A	240mV	±3%	100W	150W
PPWAM150-15A	28V	3.58A	5.36A	280mV	±2%	100W	150W
PPWAM150-17A	36V	2.78A	4.17A	300mV	±2%	100W	150W
PPWAM150-18A	48V	2.09A	3.13A	300mV	±2%	100W	150W
PPWAM150-19A	54V	1.86A	2.78A	300mV	±2%	100W	150W

NOTES:

1. See derating curves on the third page for operation above 50°C (forced air) and 40°C (convection only)
2. Testing isolation with an AC generator is not recommended. Either perform isolation testing with a DC voltage, or consult with our engineering staff for AC test considerations.
3. Model number ending with "A" indicates open frame format.
Replace "A" with "B" to indicate U-channel format.
Replace "A" with "C" indicate enclosed format.
4. Measured at 20MHz bandwidth with a 47µF electrolytic and 0.1µF ceramic capacitor in parallel with the DC output rails.

Specifications	
Input	
Input Voltage	90-264VAC
Input Frequency	47-63Hz
Input Current	2A max @ 115VAC 1A max @ 230VAC
Inrush Current	50A max @115VAC 100A max @ 230VAC
Power Factor	>0.9 (Full Load)
Output	
Total Output Power	150W with 10CFM Forced Air 100W Convection Only
Output Voltage	See models and ratings table
Hold Up Time	10mS maximum
Efficiency	Up to 92% Average Active Mode
Output Regulation	See models and ratings table
Minimum Load	No Minimum Load
Protection Features	
Overvoltage Protection	Latch Off
Overcurrent Protection	Hiccup Mode; OCP Threshold typically 105-160%
Short Circuit Protection	Hiccup Mode
Environmental	
Operating Temperature	-20°C to +70°C ¹
Storage Temperature	-20°C to +85°C
Humidity	10% - 90% RH
Operating Altitude	<5,000m (3,000m Medical)
General Specifications	
Dimensions Open Frame U-Channel Enclosed	2"W x 3"L x 1.18"H 2.52" x 3.57" x 1.5" 2.52" x 3.57" x 1.55"
Weight Open Frame U-Channel Enclosed	0.34 lbs. 0.44 lbs. 0.47 lbs.
No-Load Power Consumptions	<150mW
MTBF	250K hours per Tellcordia (Bellcore TR-332) at full load and 25°C ambient
Maximum Efficiency	>92%
Meets Efficiency Level	DoE Level VI

Specifications Continued	
Safety	
Approvals USA/Canada	UL60601-1 Ed. 3.1 UL62368-1
Approvals Europe	EN60601-1 Ed. 3.1 EN62368-1 CB to IEC62368-1 and IEC60601-1
Isolation: <ul style="list-style-type: none"> • Input to Output • Input to Ground • Output to Ground 	4000VAC / 5656VDC ² (2 x MOPP) 2000VAC / 2828VDC ² (1 x MOPP) 1500VAC / 2121VDC ² (1 x MOPP)
Earth Leakage Current	<100µA at 264Vac
EMC	
Emissions	
Radiated	EN55011 Class B EN55024 EN55032 Class B FCC Part 15 Class B FCC Part 18 Class B CE
Conducted	EN55011 Class B EN55024 EN55032 Class B FCC Part 15 Class B FCC Part 18 Class B CE
Susceptibility	
Harmonic Currents Voltage Flicker Electrostatic Discharge Radiated Immunity EFT/Burst Surge Immunity Conducted Immunity Magnetic Field Dips/Interruptions	IEC/EN60601-1-2: 2007 IEC 61000-3-2: Class A IEC 61000-3-3 IEC 61000-4-2: 15kV Air, 8kV contact IEC 61000-4-3: 10V/m IEC 61000-4-4: +/-2kV IEC 61000-4-5: 2005 1kV diff, 2kV com IEC 61000-4-6: 10Vrms IEC 61000-4-8: 30A/m IEC 61000-4-11: 30% reduction for 500ms, 100% reduction for 10ms

Diagrams

Derating Curve

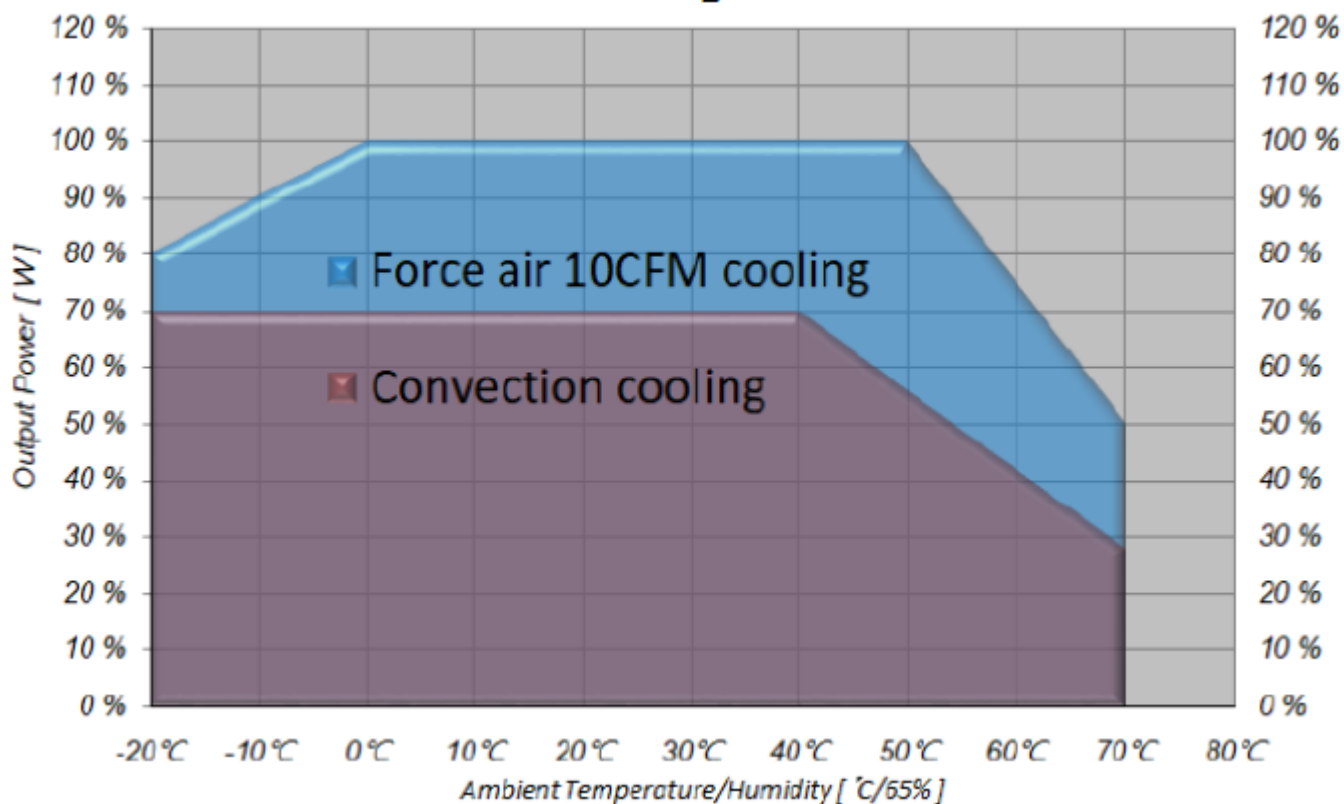

Mechanical Drawings (Open Frame)

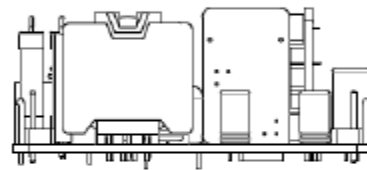
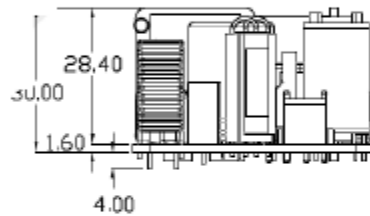
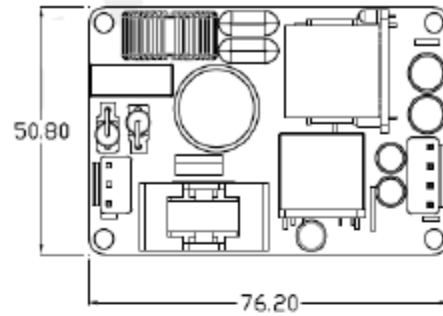

Mechanical Drawings (U-Channel)

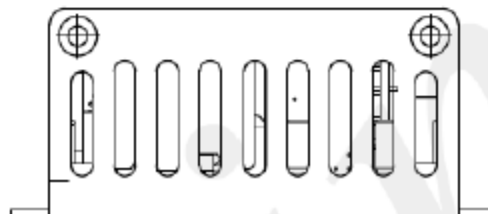
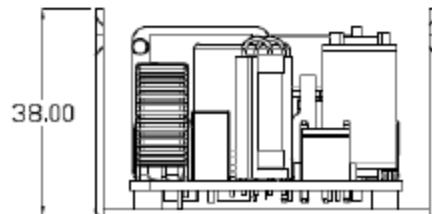
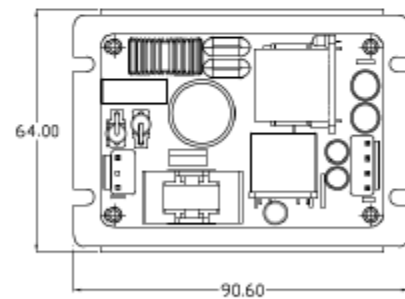

Mechanical Drawings (Enclosed)

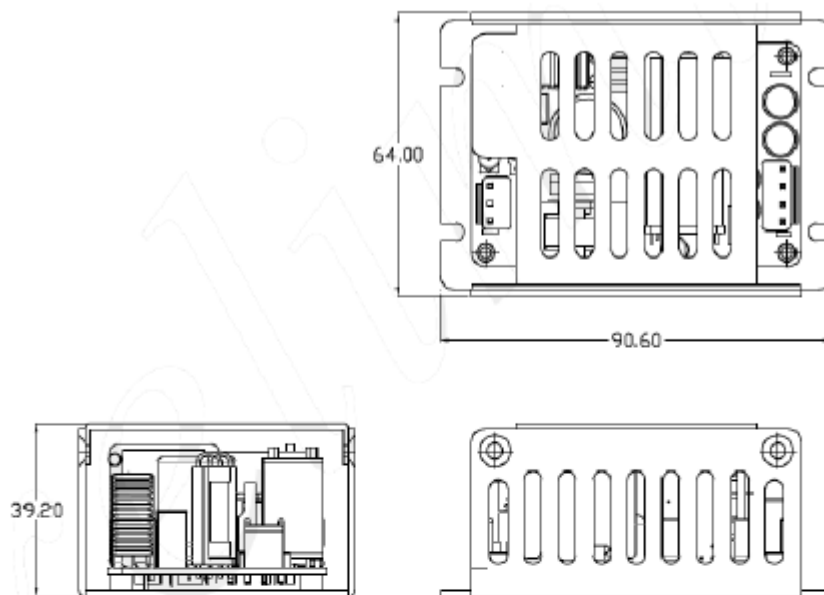

Outline Drawings

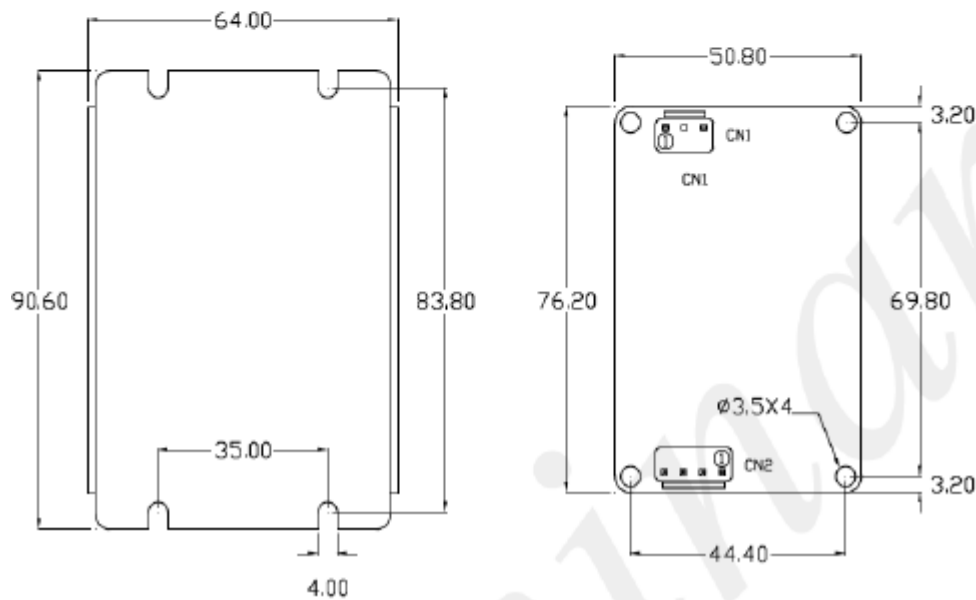

Connector Data

CN1 : Input Connector (pitch : 3.96mm)

JST B3P-VH-B or equivalent

Mates with JST VHR-3N or equivalent

Pin #	Signal
1	AC Line
2	AC Neutral

CN2 : Main Output Connector (pitch : 3.96mm / 3.81mm)

JST B4P-VH-B or equivalent

Mates with JST VHR-4N or equivalent

Pin #	Signal
1	GND
2	GND
3	+Vout
4	+Vout

Eurostyle P.C.B. 3.81mm Terminal Block
16-24 AWG (1.5mm²) Wire range

Pin #	Signal
1	GND
2	GND
3	+Vout
4	+Vout