

User Manual

# MIOe-3672/ MIOe-3674

2 or 4-port Industrial GbE PoE  
Network Card

**ADVANTECH**

*Enabling an Intelligent Planet*

---

## Copyright

The documentation and the software included with this product are copyrighted 2014 by Advantech Co., Ltd. All rights are reserved. Advantech Co., Ltd. reserves the right to make improvements in the products described in this manual at any time without notice. No part of this manual may be reproduced, copied, translated or transmitted in any form or by any means without the prior written permission of Advantech Co., Ltd. Information provided in this manual is intended to be accurate and reliable. However, Advantech Co., Ltd. assumes no responsibility for its use, nor for any infringements of the rights of third parties, which may result from its use.

## Acknowledgements

Award is a trademark of Award Software International, Inc.

VIA is a trademark of VIA Technologies, Inc.

IBM, PC/AT, PS/2 and VGA are trademarks of International Business Machines Corporation.

Intel and Pentium are trademarks of Intel Corporation.

Microsoft Windows® is a registered trademark of Microsoft Corp.

RTL is a trademark of Realtek Semi-Conductor Co., Ltd.

ESS is a trademark of ESS Technology, Inc.

UMC is a trademark of United Microelectronics Corporation.

SMI is a trademark of Silicon Motion, Inc.

Creative is a trademark of Creative Technology LTD.

All other product names or trademarks are properties of their respective owners.

## Product Warranty (2 years)

Advantech warrants to you, the original purchaser, that each of its products will be free from defects in materials and workmanship for two years from the date of purchase.

This warranty does not apply to any products which have been repaired or altered by persons other than repair personnel authorized by Advantech, or which have been subject to misuse, abuse, accident or improper installation. Advantech assumes no liability under the terms of this warranty as a consequence of such events.

Because of Advantech's high quality-control standards and rigorous testing, most of our customers never need to use our repair service. If an Advantech product is defective, it will be repaired or replaced at no charge during the warranty period. For out-of-warranty repairs, you will be billed according to the cost of replacement materials, service time and freight. Please consult your dealer for more details.

If you think you have a defective product, follow these steps:

1. Collect all the information about the problem encountered. (For example, CPU speed, Advantech products used, other hardware and software used, etc.) Note anything abnormal and list any onscreen messages you get when the problem occurs.
2. Call your dealer and describe the problem. Please have your manual, product, and any helpful information readily available.
3. If your product is diagnosed as defective, obtain an RMA (return merchandise authorization) number from your dealer. This allows us to process your return more quickly.
4. Carefully pack the defective product, a fully-completed Repair and Replacement Order Card and a photocopy proof of purchase date (such as your sales receipt) in a shippable container. A product returned without proof of the purchase date is not eligible for warranty service.
5. Write the RMA number visibly on the outside of the package and ship it prepaid to your dealer.

## Declaration of Conformity

### CE

This product has passed the CE test for environmental specifications when shielded cables are used for external wiring. We recommend the use of shielded cables. This kind of cable is available from Advantech. Please contact your local supplier for ordering information.

### FCC Class A

Note: This equipment has been tested and found to comply with the limits for a Class A digital device, pursuant to part 15 of the FCC Rules. These limits are designed to provide reasonable protection against harmful interference when the equipment is operated in a commercial environment. This equipment generates, uses, and can radiate radio frequency energy and, if not installed and used in accordance with the instruction manual, may cause harmful interference to radio communications. Operation of this equipment in a residential area is likely to cause harmful interference in which case the user will be required to correct the interference at his own expense.

---

## Safety Precaution - Static Electricity

Follow these simple precautions to protect yourself from harm and the products from damage.

- To avoid electrical shock, always disconnect the power from your PC chassis before you work on it. Don't touch any components on the CPU card or other cards while the PC is on.
- Disconnect power before making any configuration changes. The sudden rush of power as you connect a jumper or install a card may damage sensitive electronic components.

## Technical Support and Assistance

1. Visit the Advantech web site at [www.advantech.com/support](http://www.advantech.com/support) where you can find the latest information about the product.
2. Contact your distributor, sales representative, or Advantech's customer service center for technical support if you need additional assistance. Please have the following information ready before you call:
  - Product name and serial number
  - Description of your peripheral attachments
  - Description of your software (operating system, version, application software, etc.)
  - A complete description of the problem
  - The exact wording of any error messages

## Document Feedback

To assist us in making improvements to this manual, we would welcome comments and constructive criticism. Please send all such - in writing to: [support@advantech.com](mailto:support@advantech.com)

# Contents

<b>Chapter 1</b>	<b>Introduction.....</b>	<b>1</b>
1.1	Description .....	2
1.2	Features .....	2
1.3	Specifications .....	3
1.4	Ordering Information .....	3
1.5	Unpacking Checklist.....	3
<b>Chapter 2</b>	<b>Hardware Configuration.....</b>	<b>5</b>
2.1	Initial Inspection .....	6
2.2	Hardware View.....	7
	Figure 2.1 MIOe-3674 Silk Screen .....	7
	Figure 2.2 MIOe-3672 Silk Screen .....	7
	Figure 2.3 MIOe-3674 LED Indicator.....	8
2.3	Pin Assignments .....	8
2.3.1	Ethernet Connectors .....	8
	Figure 2.4 10P Connector Pin assignments .....	8
2.3.2	Ethernet LED Indicator Pin Assignments.....	9
	Figure 2.5 Ethernet LED Indicator Pin Assignments .....	9
2.3.3	PoE LED Indicator Pin Assignments.....	9
	Figure 2.6 PoE LED Connections.....	9
2.3.4	PoE 12 V Input Pin Assignments .....	10
	Figure 2.7 Power Input Connectors Pin Assignments .....	10
2.4	Card Installation .....	10
<b>Chapter 3</b>	<b>Driver Setup and Installation.....</b>	<b>11</b>
3.1	Introduction .....	12
3.2	Driver Setup .....	12
3.2.1	Steps for Windows XP/Vista/7 Driver Setup .....	12
3.3	Configuring Devices for Win XP/Vista/7.....	16
3.3.1	Jumbo Frame.....	16
3.3.2	Receive Buffer .....	18
3.3.3	Transmit Buffers.....	19
3.4	Remove PCI Express GbE PoE Device and Driver .....	20



# Chapter 1

## Introduction

This chapter provides detailed specifications for the PCI Express GbE PoE cards.

Sections include:

- Description
- Features
- Specifications
- Ordering Information
- Selection Guide

---

## 1.1 Description

Advantech MIOe-3672/ MIOe-3674 is a PCI Express by 4 (MIOe interface) with PoE (Power over Ethernet) and jumbo frame support for independent Gigabit Ethernet ports. Advantech GbE PoE cards leverage the "Plug and Play" capability defined in the PCI Express bus specification. The card requires one PCI Express by 1 or 4 MIO slot within the personal computer and provides independent Gigabit Ethernet Ports via an Intel i350 Gigabit Ethernet controller. Multiple Gigabit Ethernet Vision device connections are supported for standard Gigabit Ethernet Vision data transfer rates of up to 1000 Mbps.

MIOe-3672 and MIOe-3674 feature 802.3af PoE standard, combining power supply, jumbo frame package, power isolation and IEEE 1588(precise time protocol) to enable synchronization with multi-camera or PD acquisition.

Each port of MIOe-3672 and MIOe-3674 can deliver up to 15.4 W of power (external 12 VDC is needed) and 1000 Mb/s bandwidth over a CAT-5/CAT-6/CAT-7 cable of up to 100 meters. It features 9 kB jumbo frame and link aggregation, which conduct exceptional performance for continuously receiving large amount of image data.

The PoE technology significantly reduces the installation and maintenance cost by eliminating the power wire. Combining PoE and the Gigabit bandwidth, MIOe-3672 and MIOe-3674 are the perfect fit for your vision applications!

## 1.2 Features

- IEEE802.3af compliant, supporting classes 0,1,2,3,4
- Support for four independent GbE ports
- Powered Device (PD) auto-detection and classification
- Built-in 2.25KV isolation protection on LAN ports and power, ESD 8KV and EFT 2KV
- IEEE 1588 compliant
- PCI Express x4 compliant
- Support for Link aggregation
- Support for jumbo frames (9014 Bytes)
- Inrush current, current limit, and short-circuit protection



## 1.3 Specifications

- **Power Over Ethernet Port**
  - 2 or 4 Gigabit Ethernet Media Access Control (MAC) and physical layer (PHY) ports.
  - Full controller compliance with IEEE 802.3.af standard for maximum 15.4 watts, with power up to 48 V over existing Ethernet infrastructure, with no modifications required
  - Standard IEEE 802.3 Ethernet interface provided for 1000BASE-T, 100BASE-TX, and 10BASE-T applications (802.3, 802.3u, and 802.3ab, 802.3x)
  - 9014 bytes jumbo frame support
- **Bus Interface**
  - PCIe bus spec. 1.2 compliant
- **Power Requirements**
  - Input voltage: 12 VDC, (w/ PC system power)
  - Input current:
    - Max. 6 A @ 12 VDC (supporting up to 4 ports at 15.4 Watt per PoE port)
    - Max. 3 A @ 12 VDC (supporting up to 2 ports at 15.4 Watt per PoE port)
  - Surge Protection: 1 kV
  - Connector: AT/ATX System power input or 8-pin box header
- **Isolation Protection**
  - 2.25KV isolation on LAN and power
- **ESD/EFT**
  - 8KV ESD and 2KV EFT
- **Physical**
  - Dimensions (W x D): 145 x 114 mm
  - Operating Temperature:
    - 0°C to 50°C (normal)
    - 0°C to 60°C \* (Ambient; 0 CFS airflow)
  - Safety Compliance: CE/FCC

**Note!** *With an external heat sink. Airflow required for operation in 60°C ambient temperature.*



## 1.4 Ordering Information

- MIOe-3672: 2-port 10/100/1000 BaseT(X) 802.3af (PoE) Compliant Ethernet ports
- MIOe-3674: 4-port 10/100/1000 BaseT(X) 802.3af (PoE) Compliant Ethernet ports

## 1.5 Unpacking Checklist

Ensure that the following items are included in the package.

- MIOe-3672 or MIOe-3674 unit
- Driver Installation CD-ROM
- 2\*2P / B4P Cable



# Chapter 2

## Hardware Configuration

This chapter provides information on the hardware configuration of PCI Express GbE PoE cards.

Sections include:

- Initial Inspection
- Jumper and Switch Locations
- Jumper Settings
- Card Installation

---

## 2.1 Initial Inspection

You should find the following items inside the shipping package:

- MIOe-3672 or MIOe-3674 unit
- Driver Installation CD-ROM
- 2\*2P / B4P Cable

We carefully inspected the MIOe-3672 or MIOe-3674 mechanically and electrically before we shipped it. It should be free of marks and scratches and in perfect working order on receipt.

As you unpack the MIOe-3672 or MIOe-3674 check it for signs of shipping damage (damaged box, scratches, dents, etc.). If it is damaged or it fails to meet specifications, notify our service department or your local sales representative immediately. Also notify the carrier. Retain the shipping carton and packing material for inspection by the carrier. After inspection we will make arrangements to repair or replace the unit.

When you handle the MIOe-3672 or MIOe-3674, remove it from its protective packaging by grasping the edge of the card. Keep the anti-vibration packing. Whenever you remove the card from the PC, store it in this package for protection.

**Warning!** *Discharge your body's static electric charge by touching the back of the grounded chassis of the system unit (metal) before handling the board. You should avoid contact with materials that hold a static charge such as plastic, vinyl and styrofoam. Handle the board only by its edges to avoid static damage to its integrated circuits. Avoid touching the exposed circuit connectors. We also recommend that you use a grounded wrist strap and place the card on a static dissipative mat whenever you work with it.*



## 2.2 Hardware View

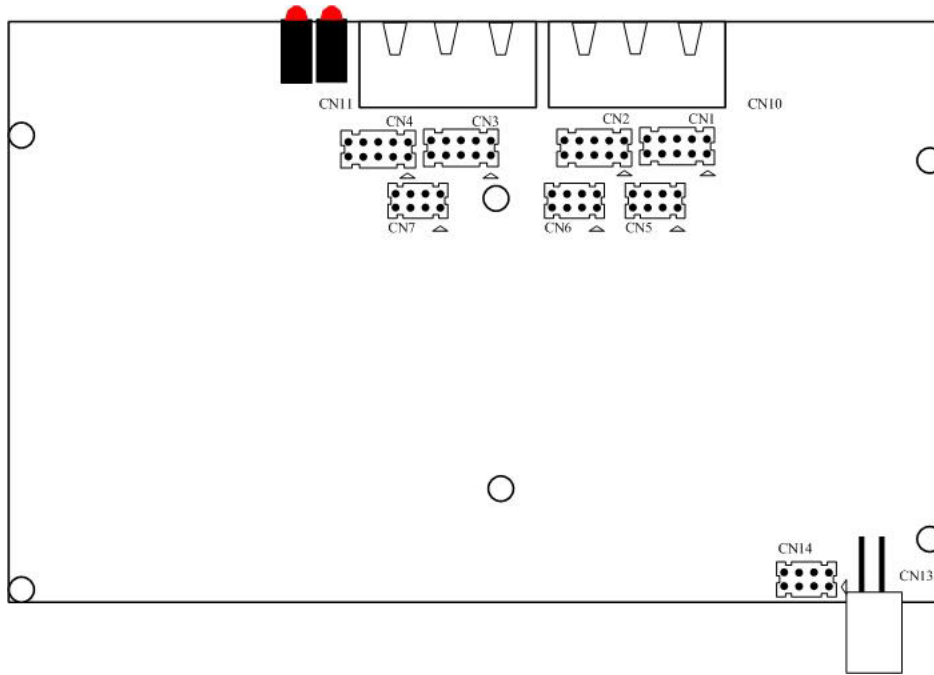

Figure 2.1 MIOe-3674 Silk Screen

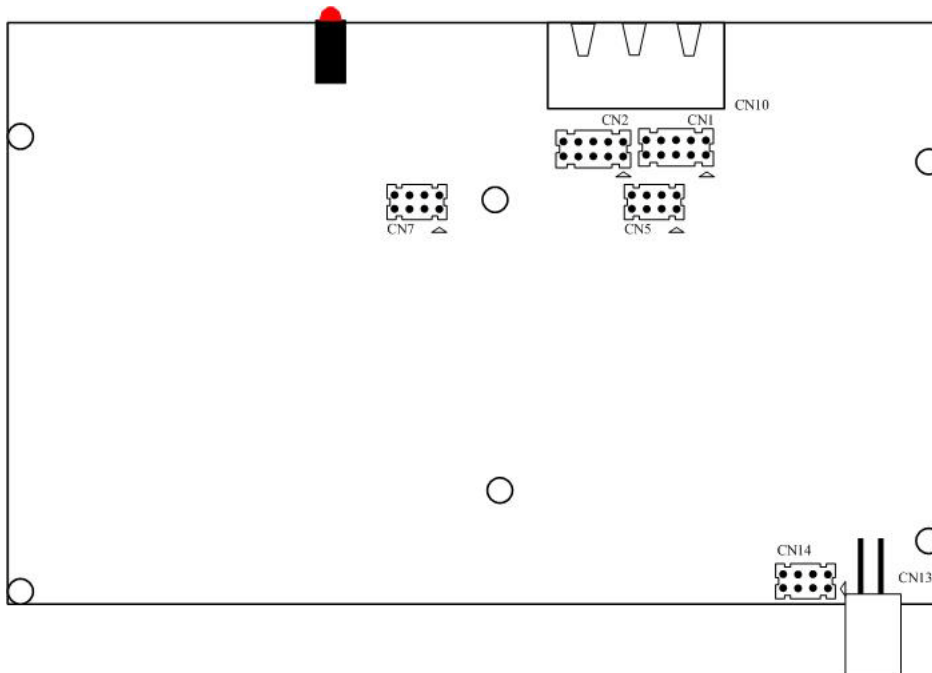
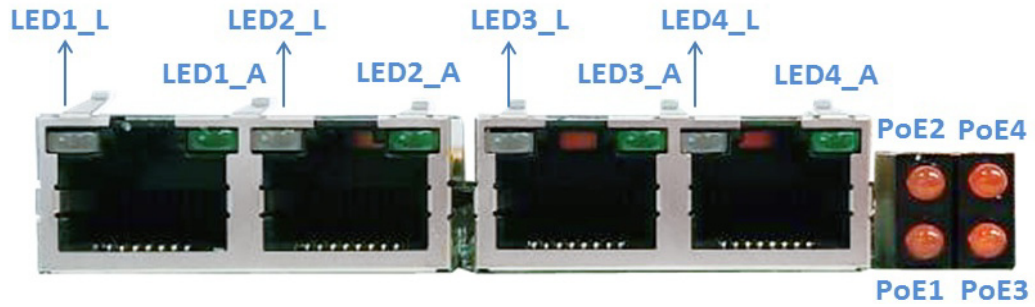

Figure 2.2 MIOe-3672 Silk Screen



LED	Description	Behavior
LEDx_L	10/100/1000 Link	Orange: 1 Gbps; Green: 100 Mbps OFF: 10 Mbps or no link
LEDx_A	Activity	Blink: receiving or transmitting packets ON: idle OFF: no link
PoEx	PoE	ON Indicates POE is enabled

Figure 2.3 MIOe-3674 LED Indicator

## 2.3 Pin Assignments

### 2.3.1 Ethernet Connectors

Figure 2.4 shows the pin assignment of the CN1-CN4 connectors, they correspond to the Ethernet signals of Ch0 to Ch3.

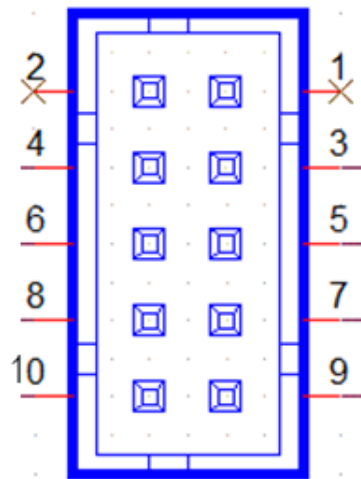

PIN	Ethernet		PoE
	10/100	1,000	
1	NA		
2	NA		
3	NC	DD+	NC
4	NC	DD-	NC
5	NC	DC+	NC
6	NC	DC-	NC
7	RX+	DB+	48V -
8	RX-	DB-	48V -
9	TX+	DA+	48V +
10	TX-	DA-	48V +

Figure 2.4 10P Connector Pin assignments

## 2.3.2 Ethernet LED Indicator Pin Assignments

Figure 2.5 shows CN5 and CN6 pin assignments that provide extra LED wiring for customer to monitor each Ethernet port status.

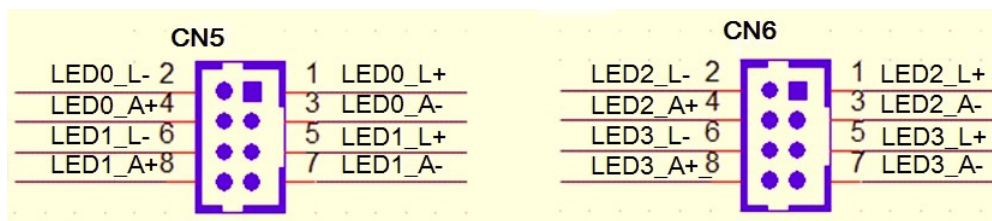

LED	Description	Behavior
LEDx_L	100/100/1000 Link	Orange: 1Gbps Green: 100 Mbps OFF: 10 Mbps or no link
LEDx_A	Activity	Blink: receiving or transmitting packets ON: idle OFF: no link

Figure 2.5 Ethernet LED Indicator Pin Assignments

## 2.3.3 PoE LED Indicator Pin Assignments

Figure 2.6 shows CN7 pin assignments that provide extra LED wiring for customer to monitor each PoE port status.

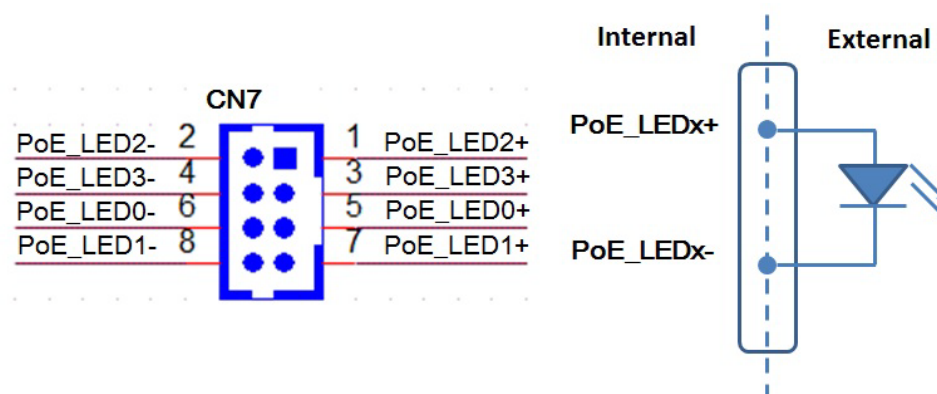

Figure 2.6 PoE LED Connections

## 2.3.4 PoE 12 V Input Pin Assignments

CN13 and CN14 are connectors for PoE 12 V input. When using PoE function, users have to connect 12V power to either one as power supply.

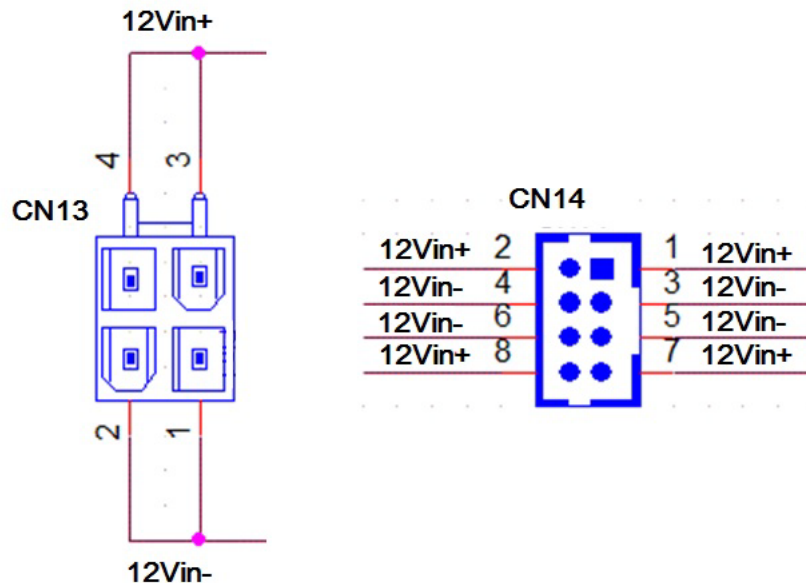

Figure 2.7 Power Input Connectors Pin Assignments

## 2.4 Card Installation

**Note!** We strongly recommend that you install the software driver before you install the hardware into your system, since this will guarantee a smooth and trouble-free installation process.



Turn off your PC's power supply whenever you install or remove the PCI Express GbE PoE card or its cables. Static electricity can easily damage computer equipment. Ground yourself by touching the chassis of the computer (metal) before you touch any boards. See the static warning on Ch.2

1. Turn off the computer and all peripheral devices (such as printers and monitors).
2. Disconnect the power cord and any other cables from the back of the computer.
3. Remove the PC's cover (refer to your user's guide if necessary).
4. Install and plug the PCI Express GbE PoE card on your PCI Express BUS.
5. Replace the PC's cover. Connect the cables you removed in step 3 and connect the power connector and power supply with the power cable in the package.
6. Turn the computer power on.
7. Install the driver in PCI Express GbE PoE CD-ROM, see chapter 3.1, 3.2 and 3.3.
8. Test your Ethernet port and verify if Ethernet port could work normally, see chapter 3.



# Chapter 3

## Driver Setup and Installation

This chapter describes the driver installation, configuration and removal procedures for the Windows operating system, including Windows XP/Vista/7.

Sections include:

- Introduction
- Driver Setup

## 3.1 Introduction

This chapter describes the driver installation, configuration and removal procedures for the Windows operating system, including Windows XP/Vista/7 32/64 bits.

## 3.2 Driver Setup

In order to fully utilize the advanced features of Windows XP/Vista/7, such as multi-process and multithread, pure 32-bit and 64-bit Windows XP/Vista/7 device drivers are provided for the PCI Express GbE PoE cards.

### 3.2.1 Steps for Windows XP/Vista/7 Driver Setup

Please follow the steps below for the PCI Express GbE PoE card's Windows 32-bit/64-bit driver installation.

1. Insert your companion CD-ROM disc into your CD-ROM drive.
2. Look up **Autorun.exe** on the companion CD-ROM and execute..

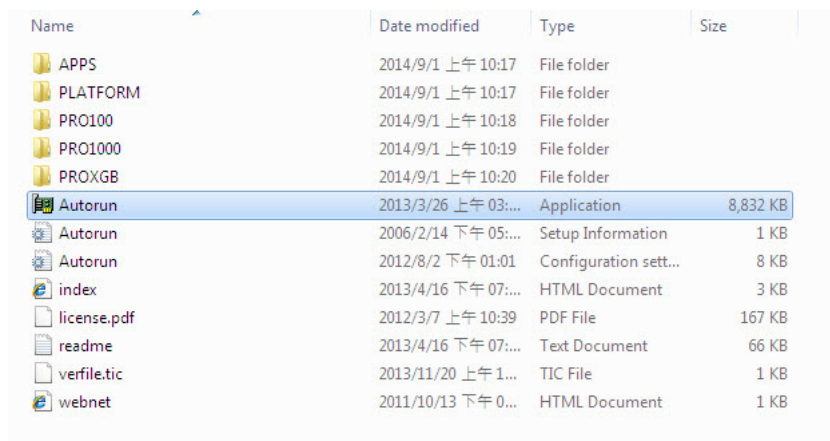

Name	Date modified	Type	Size
APPS	2014/9/1 上午 10:17	File folder	
PLATFORM	2014/9/1 上午 10:17	File folder	
PRO100	2014/9/1 上午 10:18	File folder	
PRO1000	2014/9/1 上午 10:19	File folder	
PROXGB	2014/9/1 上午 10:20	File folder	
<b>Autorun</b>	2013/3/26 上午 03:...	Application	8,832 KB
Autorun	2006/2/14 下午 05:...	Setup Information	1 KB
Autorun	2012/8/2 下午 01:01	Configuration sett...	8 KB
index	2013/4/16 下午 07:...	HTML Document	3 KB
license.pdf	2012/3/7 上午 10:39	PDF File	167 KB
readme	2013/4/16 下午 07:...	Text Document	66 KB
verfile.tic	2013/11/20 上午 1...	TIC File	1 KB
webnet	2011/10/13 下午 0...	HTML Document	1 KB

3. After the setup program is launched, you'll see the following screen and click "Install Drivers and Software" button.

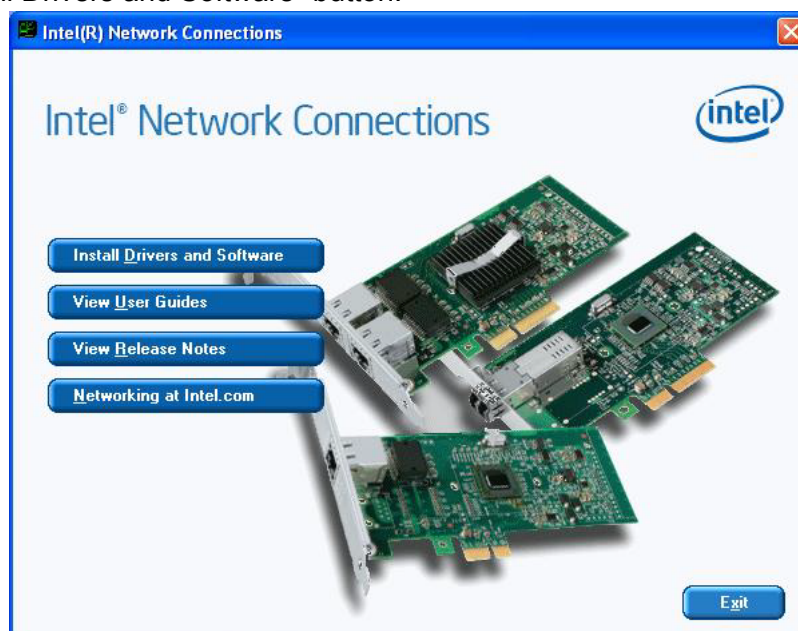

4. Then click the “Next” button.

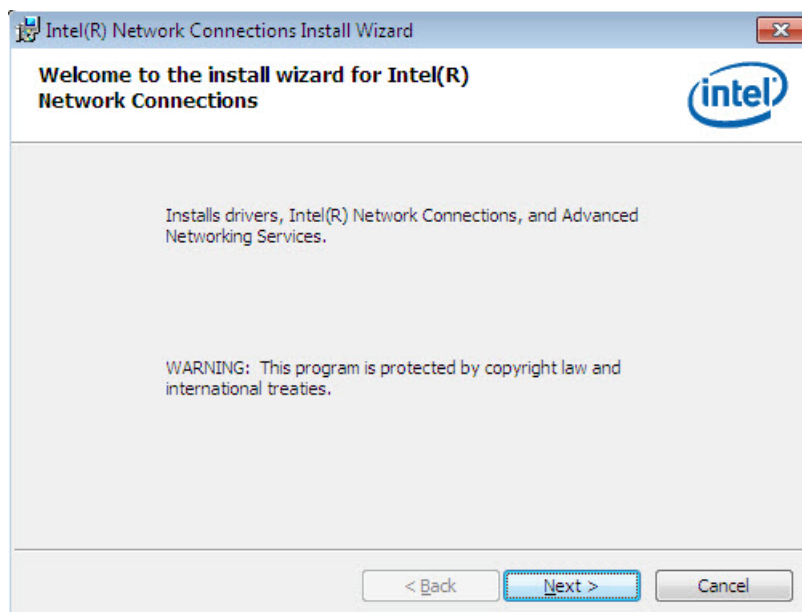

5. Click the “I accept the terms in the license agreement” button to agree to the license agreement.

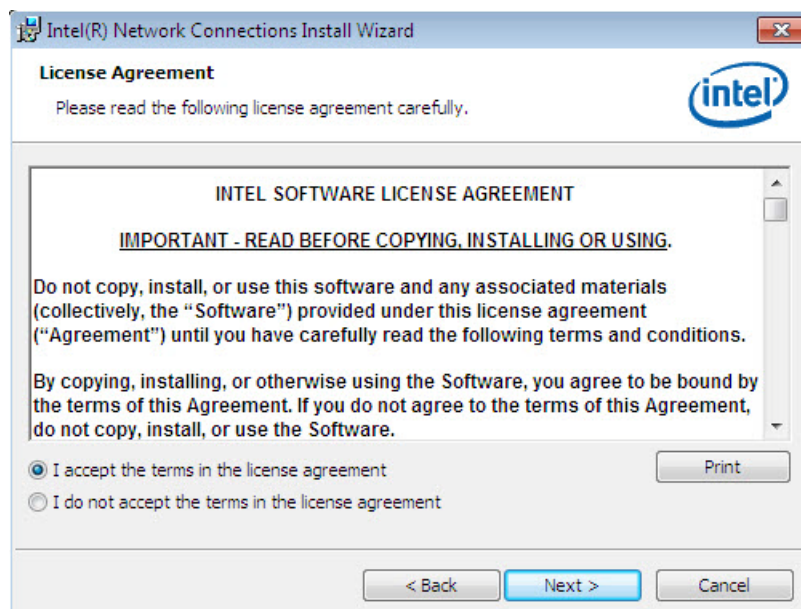

6. It will show all available drivers, select the program features you want installed and click “**Next**”

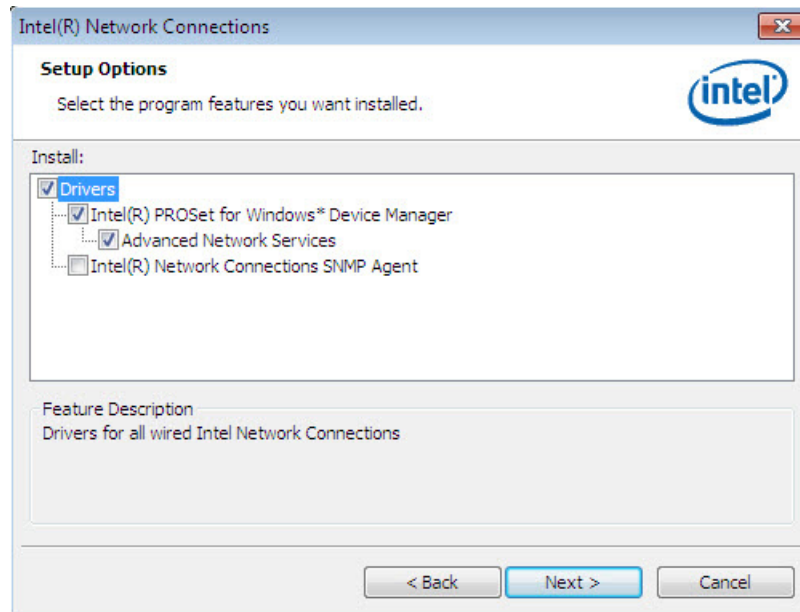

7. Click “**Install**” to begin the installation

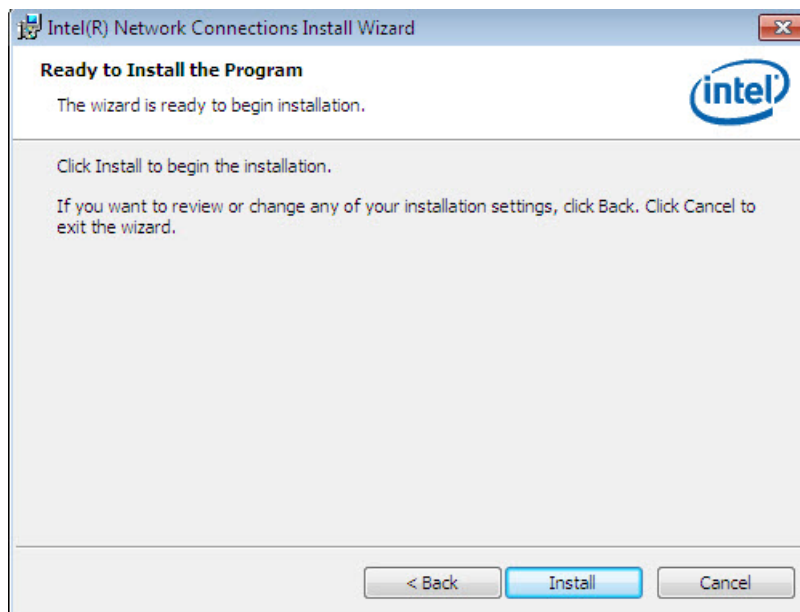

8. Please wait for few minutes and Intel shield wizard installs network connection.

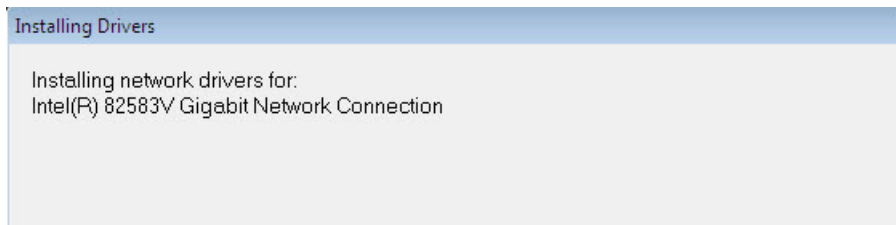
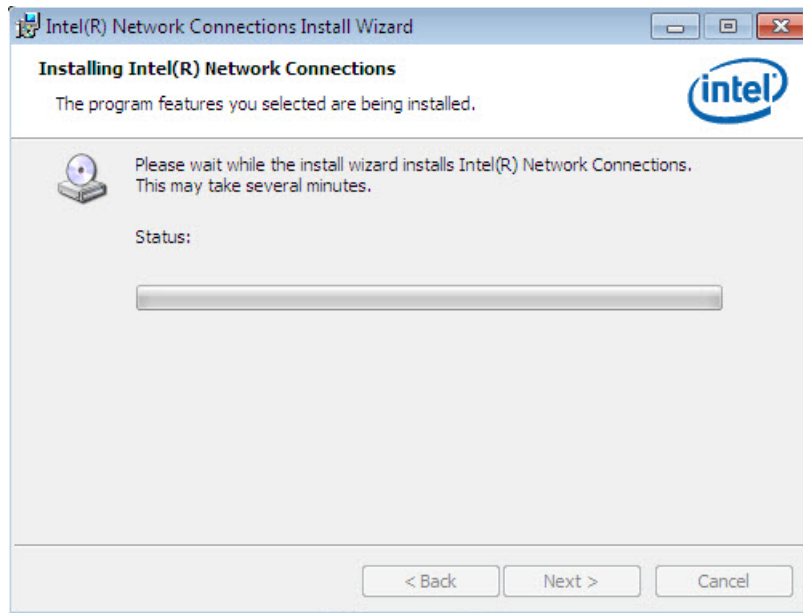

9. After that, you will be able to find the adapters from device manager.

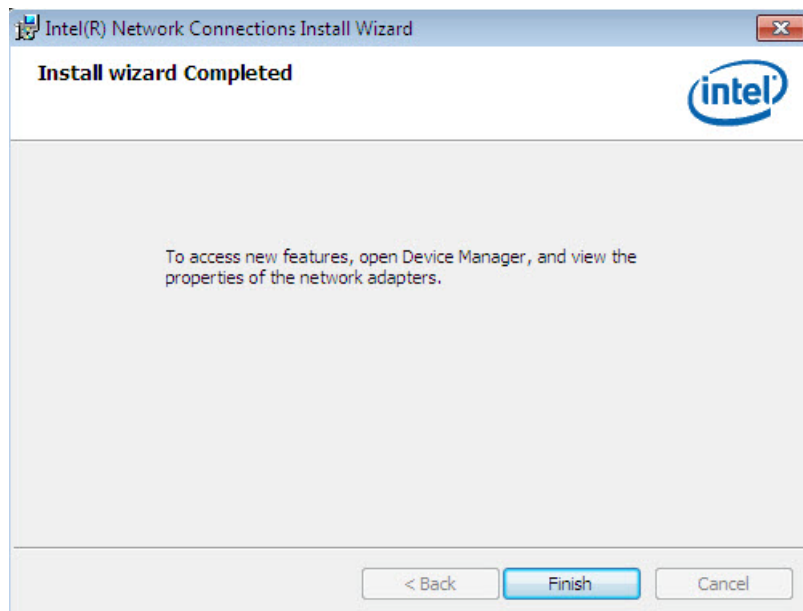

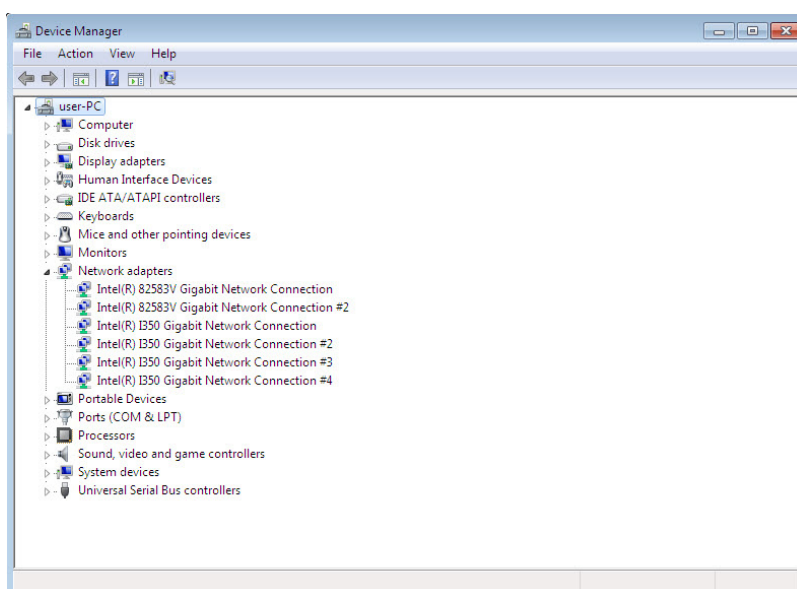

### 3.3 Configuring Devices for Win XP/Vista/7

MIOe-1672PC and MIOe-1674PC offer the Gigabit Ethernet connectivity via Intel® i350 GbE controller. When connecting to a high-speed PoE device, such as a GigE camera, you can adjust some driver settings to have better transmission throughput and connection stability.

In this section, we'll discuss these settings. You can refer to the information to fine tune your system.

#### 3.3.1 Jumbo Frame

Jumbo frames are Ethernet frames with more than 1500 bytes of payload. By increasing the payload size, a certain large amount of data can be transferred with less interrupts generated, which reduces the CPU utilization and increases overall data throughput. Intel® i350 GbE controller supports jumbo frame size of up to 9 Kbytes. When you connecting an Ethernet device with high data rate (e.x. a Gigabit Ethernet camera), enabling jumbo frame feature is highly recommended.

After installing the driver for Intel® i350 GbE controller, you can change the jumbo frame settings by following the steps listed below.

1. Open the **Device Manager of Computer Management** and click the right button of “Advantech PCI Express GbE PoE adapte” and select **Property**.

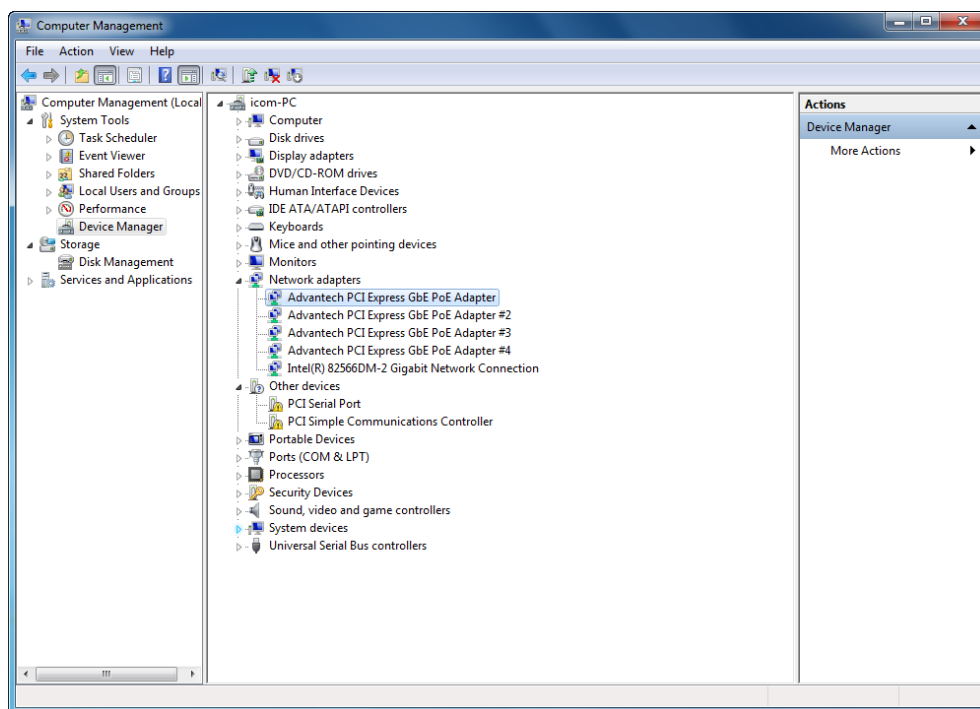

2. Click **Configure** button and a property dialog appears. Click on the **Advanced** tab.
3. Select the **Jumbo Packet** settings, and select the expected jumbo frame size. (for connecting a Ethernet device with high data rate, 9014 Bytes is suggested)

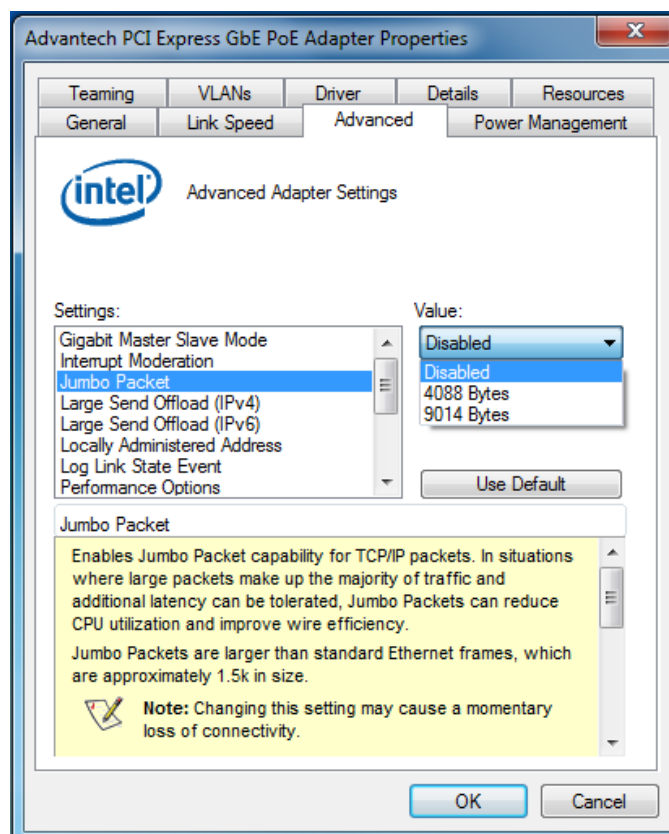

### 3.3.2 Receive Buffer

Receive buffer is another option which can affect data throughput. It determines the size of memory buffer allocated for receiving data. Increasing size of receive buffer can improve the performance of receiving data. The default settings of receive buffer is 256 bytes. When connecting to an Ethernet device that generates large amount of data, you can set this option to a larger value (maximal 2048 bytes) for better performance.

You can change the settings of receive buffer by following the steps listed below.

1. Select the **Performance Options** settings and click the **Properties** button.

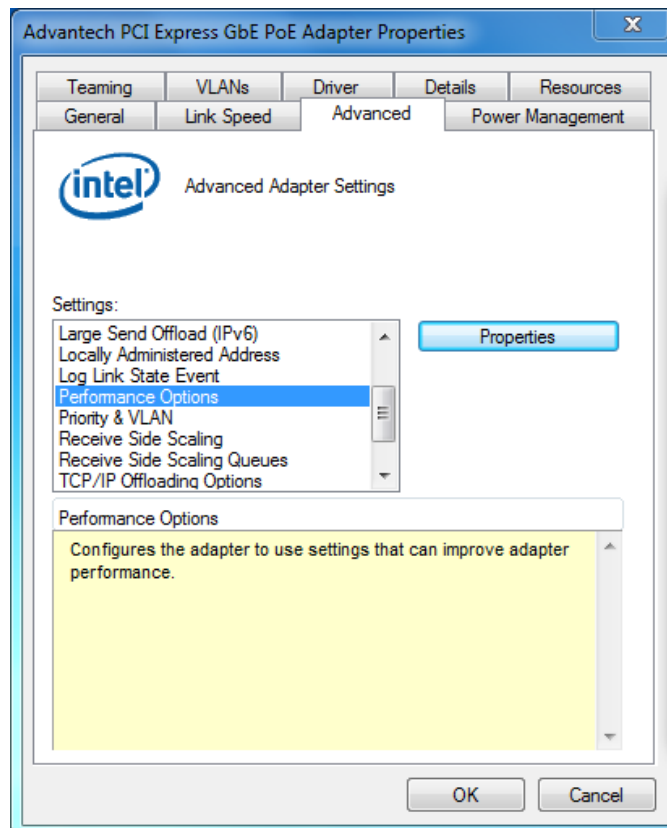

2. Adjust the value of **Receive Buffers**. The default value is 256 Bytes. (for connecting a Ethernet device with high data rate, 2048 Bytes is suggested)

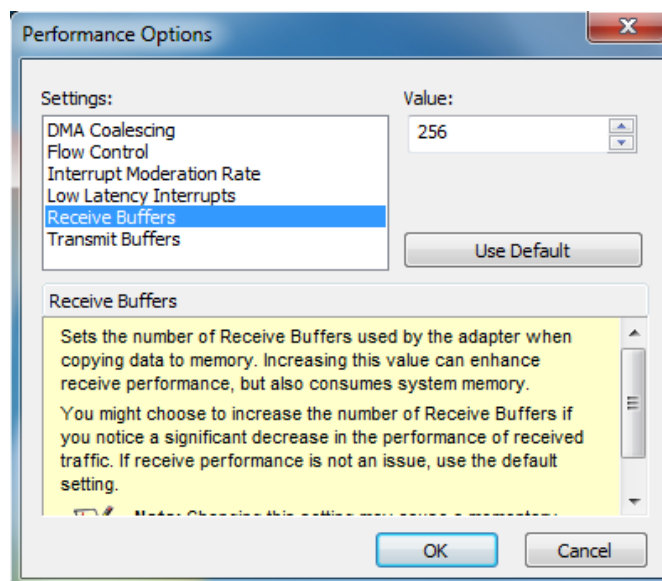



### 3.3.3 Transmit Buffers

Like receive buffer, transmit buffer can affect the performance of transmitting data. The default settings of receive buffer is 256 bytes. If you encounter a performance issue while transmitting data, you can adjust the size of transmit buffer to a larger value (maximal 2048 bytes) for better performance.

You can change the settings of transmit buffer by following the steps listed below.

1. Select the **Performance Options** settings and click the **Properties** button.

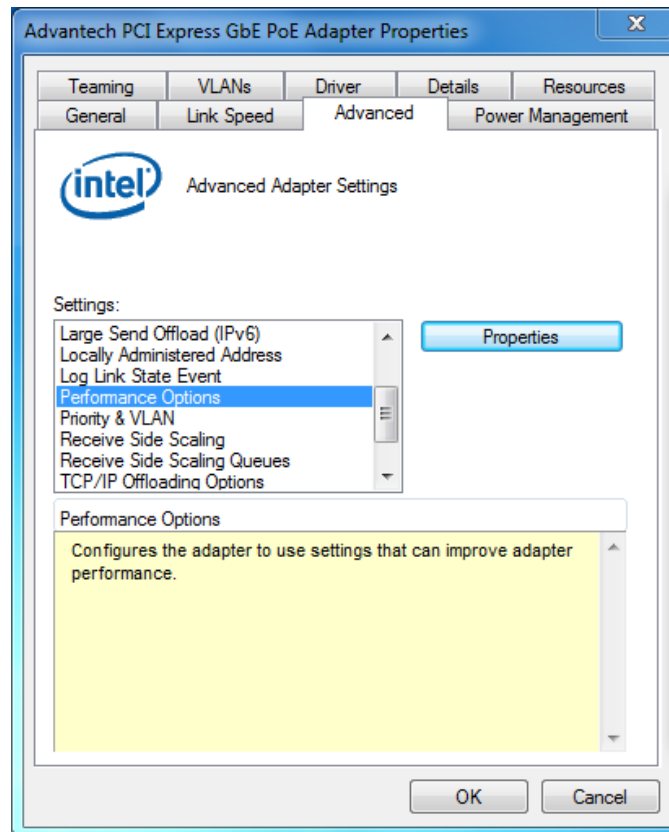

2. Adjust the value of **Transmit Buffers**.

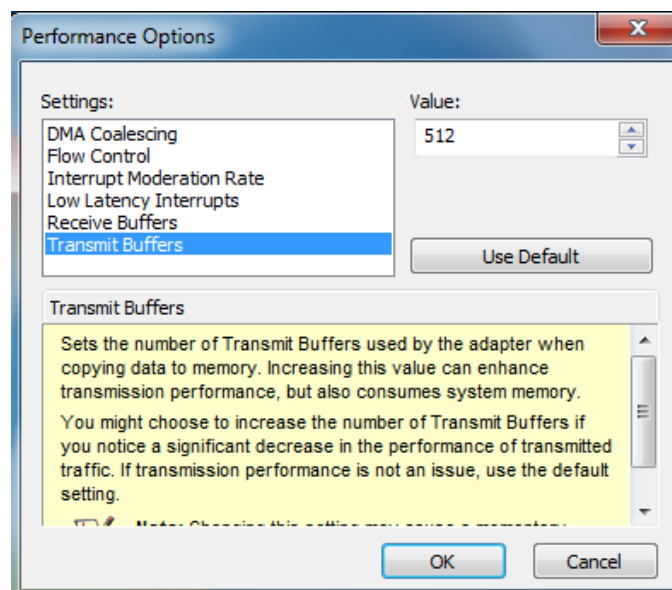

## 3.4 Remove PCI Express GbE PoE Device and Driver

1. Access Control Panel (Add/Remove Programs) to bring up the Change or Remove Programs window.

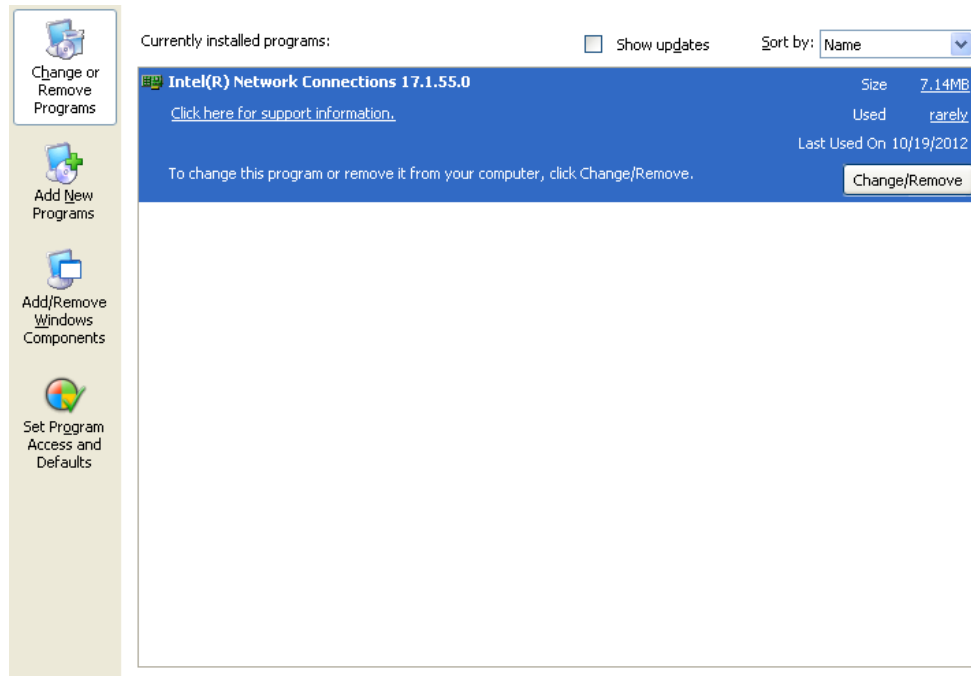

2. Select the "Intel® network Connections 17.1.55.0" tab and click "Change/Remove" button, then it will start to remove the driver for Advantech PCI Express GbE PoE adapters.

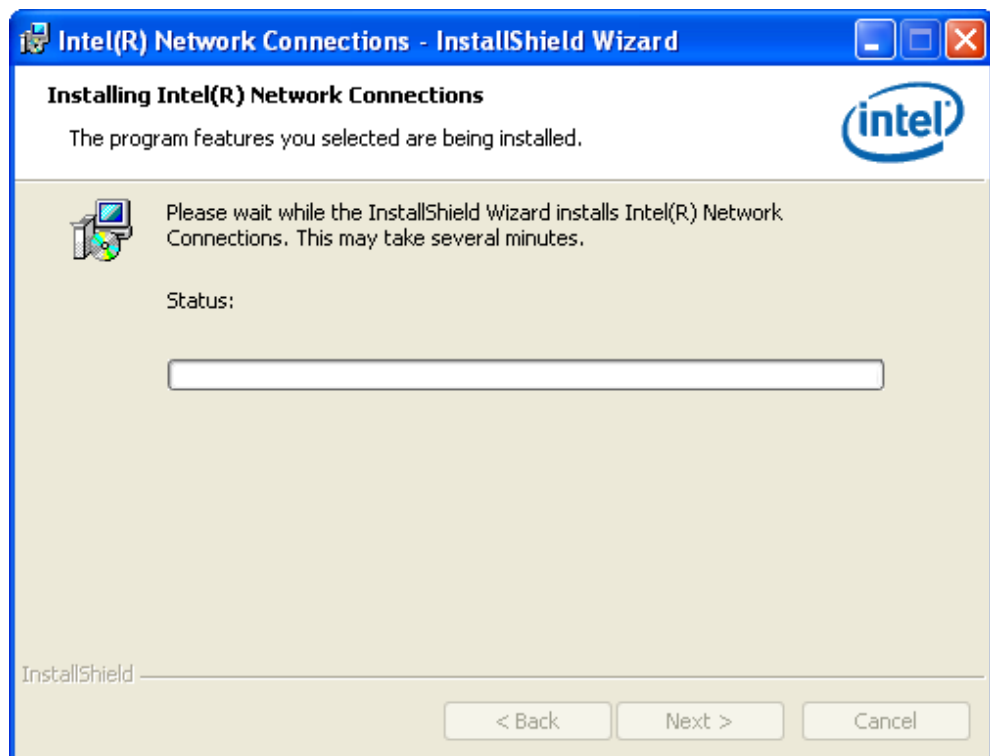



## [www.advantech.com](http://www.advantech.com)

Please verify specifications before quoting. This guide is intended for reference purposes only.

All product specifications are subject to change without notice.

No part of this publication may be reproduced in any form or by any means, electronic, photocopying, recording or otherwise, without prior written permission of the publisher.

All brand and product names are trademarks or registered trademarks of their respective companies.

© Advantech Co., Ltd. 2014