

DO NOT SCALE FROM THIS PRINT

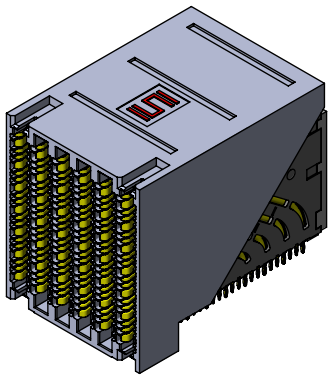

DESIGNED & DIMENSIONED IN MILLIMETERS [INCHES]

EBTF-6-XX-2.0-X-RA-X-X-X-X

NO OF PAIRS PER COLUMN

-6

COLUMNS

**-.06
**-.08
**-.10
-12

COLUMN PITCH

-2.0: 2.0 mm

PLATING SPECIFICATION

-S: 30µ" SELECTIVE GOLD IN CONTACT AREA, MATTE TIN ON TAIL

ORIENTATION

-RA: RIGHT ANGLE

OPTIONS

BLANK: THICK END WALLS
-T: THIN END WALLS

KEYING

(ONLY AVAILABLE WITH -L OR -R GUIDANCE)

BLANK: NO KEYING

*-A THRU -H: DENOTES POSITION OF FLAT ON KEY (SEE TABLE 1, SHT 5)

GUIDANCE

BLANK: NONE

**-.L: LEFT (SEE FIG 6, SHT 6)

**-.R: RIGHT (SEE FIG 5, SHT 5)

PIN CONFIGURATION

-1: STANDARD

*-2: ADVANCED MATE (SEE FIG 2, SHT 4)

*-3: SHORT DETECT (SEE FIG 3, SHT 4)

*-4: ADVANCED MATE AND SHORT DETECT (SEE FIG 4, SHT 4)

(* = NOT TOOLED)
(** = NOT RELEASED)

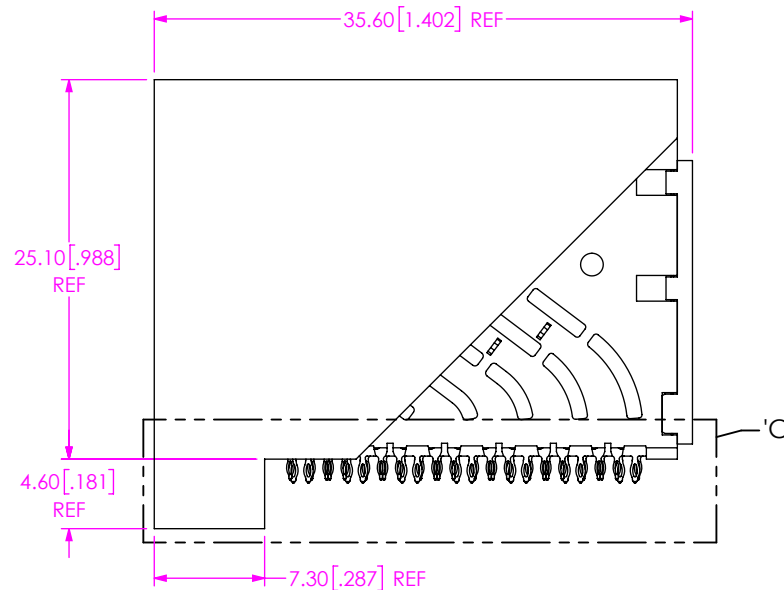
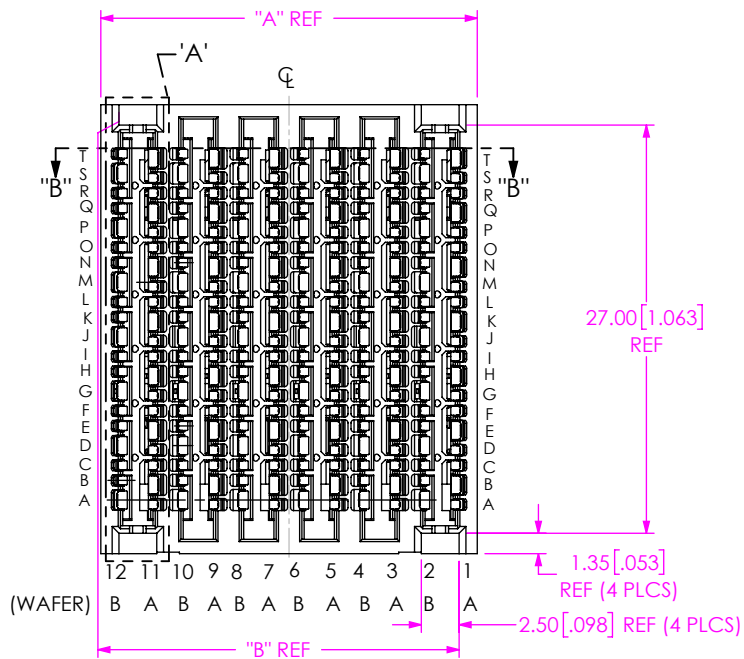

COLUMNS	"A"	"A" (WITH -T OPTION)	"B"	"C"	"D"	"E"
**-.06	12.90 [0.508]	11.90 [0.469]	10.50 [0.413]	8.00 [0.315]	10.00 [0.394]	5.20 [0.205]
**-.08	16.90 [0.665]	15.90 [0.626]	14.50 [0.571]	12.00 [0.472]	14.00 [0.551]	7.20 [0.283]
**-.10	20.90 [0.823]	19.90 [0.783]	18.50 [0.728]	16.00 [0.630]	18.00 [0.709]	9.20 [0.362]
-12	24.90 [0.980]	23.90 [0.941]	22.50 [0.886]	20.00 [0.787]	22.00 [0.866]	11.20 [0.441]

(** = NOT RELEASED)

NOTES:

1. MINIMUM PUSHOUT FORCE: 2.22N [5 LB].
2. CONTACT SAMTEC FOR CONNECTOR PRESS FIT INSTRUCTIONS.
3. TRAYS TO BE STANDARD PACKAGING.

FIG 1
EBTF-6-12-2.0-X-RA-1 SHOWN

<p>UNLESS OTHERWISE SPECIFIED, DIMENSIONS ARE IN MILLIMETERS.</p>	<p>PROPRIETARY NOTE</p> <p>THIS DOCUMENT CONTAINS CONFIDENTIAL AND PROPRIETARY INFORMATION AND ALL DESIGN, MANUFACTURING, REPRODUCTION, USE, PATENT RIGHTS AND SALES RIGHTS ARE EXPRESSLY RESERVED BY SAMTEC, INC. THIS DOCUMENT SHALL NOT BE DISCLOSED, IN WHOLE OR PART, TO ANY UNAUTHORIZED PERSON OR ENTITY NOR REPRODUCED, TRANSFERRED OR INCORPORATED IN ANY OTHER PROJECT IN ANY MANNER WITHOUT THE EXPRESS WRITTEN CONSENT OF SAMTEC, INC.</p>	<p>520 PARK EAST BLVD., NEW ALBANY, IN 47150 PHONE: 812-944-6733 FAX: 812-948-5047 e-Mail: info@SAMTEC.com code 53322</p>
	<p>MATERIAL: DO NOT SCALE DRAWING SHEET SCALE: 2.5:1</p> <p>INSULATOR: LCP, UL 94-V0; COLOR: BLACK CONTACT: COPPER ALLOY SHIELD: COPPER ALLOY</p>	

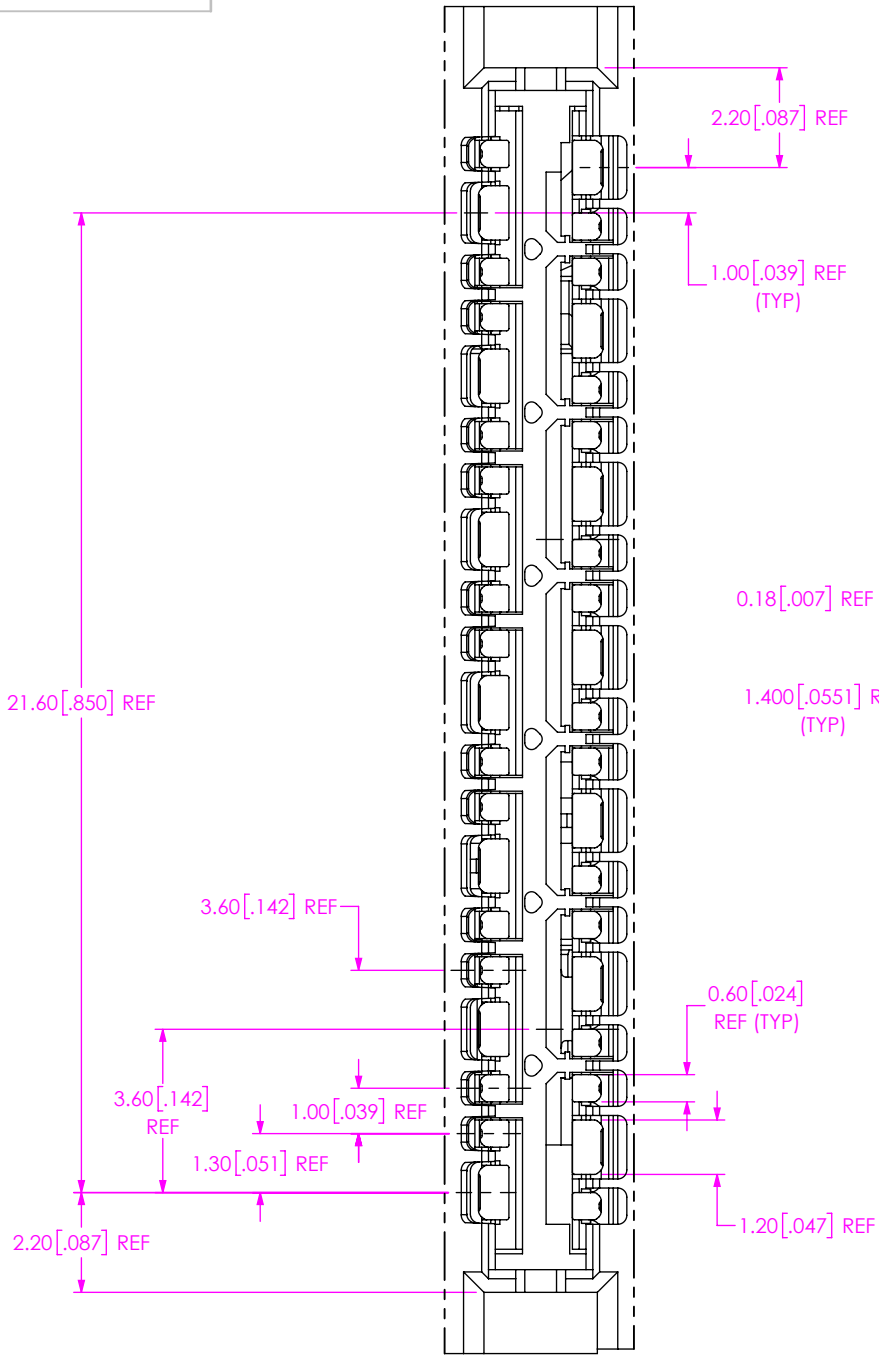

DETAIL 'A'
SCALE 6 : 1

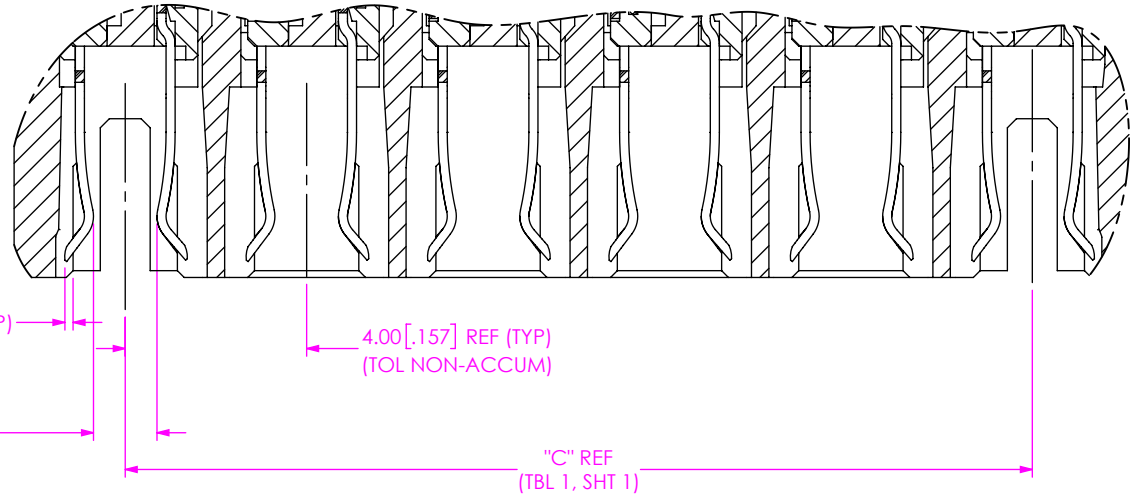

SECTION "B"- "B"
SCALE 6 : 1

PROPRIETARY NOTE
 * THIS DOCUMENT CONTAINS CONFIDENTIAL AND PROPRIETARY INFORMATION AND ALL DESIGN, MANUFACTURING, REPRODUCTION, USE, PATENT RIGHTS AND SALES RIGHTS ARE EXPRESSLY RESERVED BY SAMTEC, INC. THIS DOCUMENT SHALL NOT BE DISCLOSED, IN WHOLE OR PART, TO ANY UNAUTHORIZED PERSON OR ENTITY NOR REPRODUCED, TRANSFERRED OR INCORPORATED IN ANY OTHER PROJECT IN ANY MANNER WITHOUT THE EXPRESS WRITTEN CONSENT OF SAMTEC, INC.

DO NOT SCALE DRAWING
 SHEET SCALE: 2:1

samtec
 520 PARK EAST BLVD, NEW ALBANY, IN 47150
 PHONE: 812-944-6733 FAX: 812-948-5047
 e-Mail info@SAMTEC.com code 55322

DESCRIPTION:
 EXAMAX™ RIGHT ANGLE RECEPTACLE ASSEMBLY
 DWG. NO.
 EBTf-6-XX-2.0-X-RA-X-X-X-X
 BY: J. BROWNING 11/19/2014 SHEET 2 OF 7

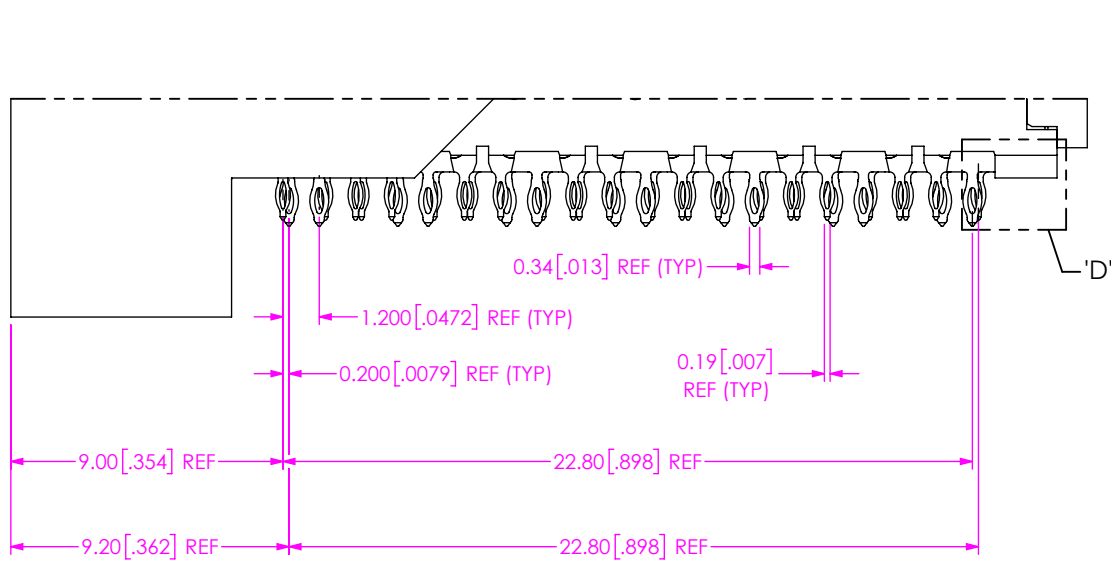

DETAIL 'C'
SCALE 4 : 1

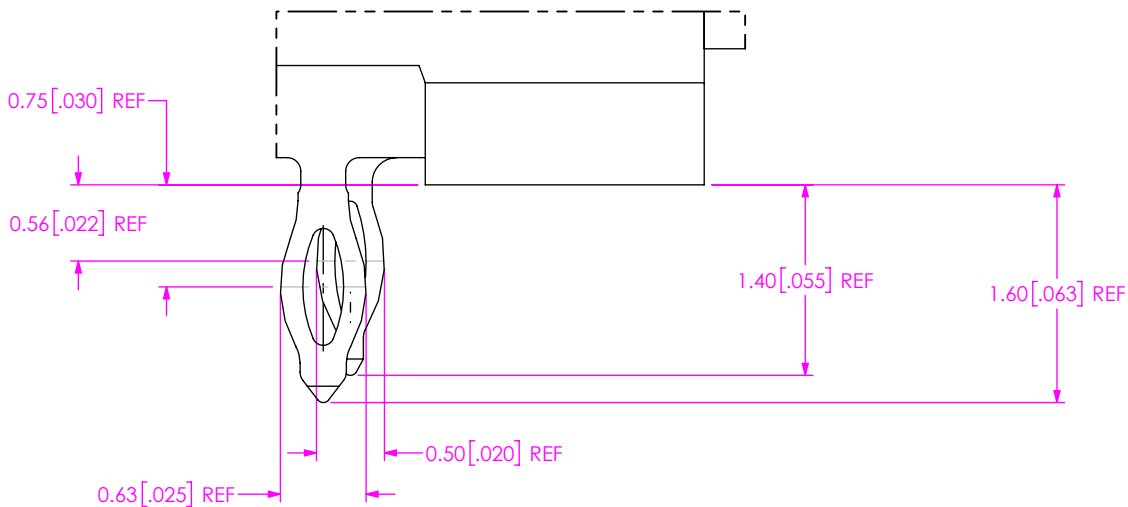

DETAIL 'D'
SCALE 18 : 1

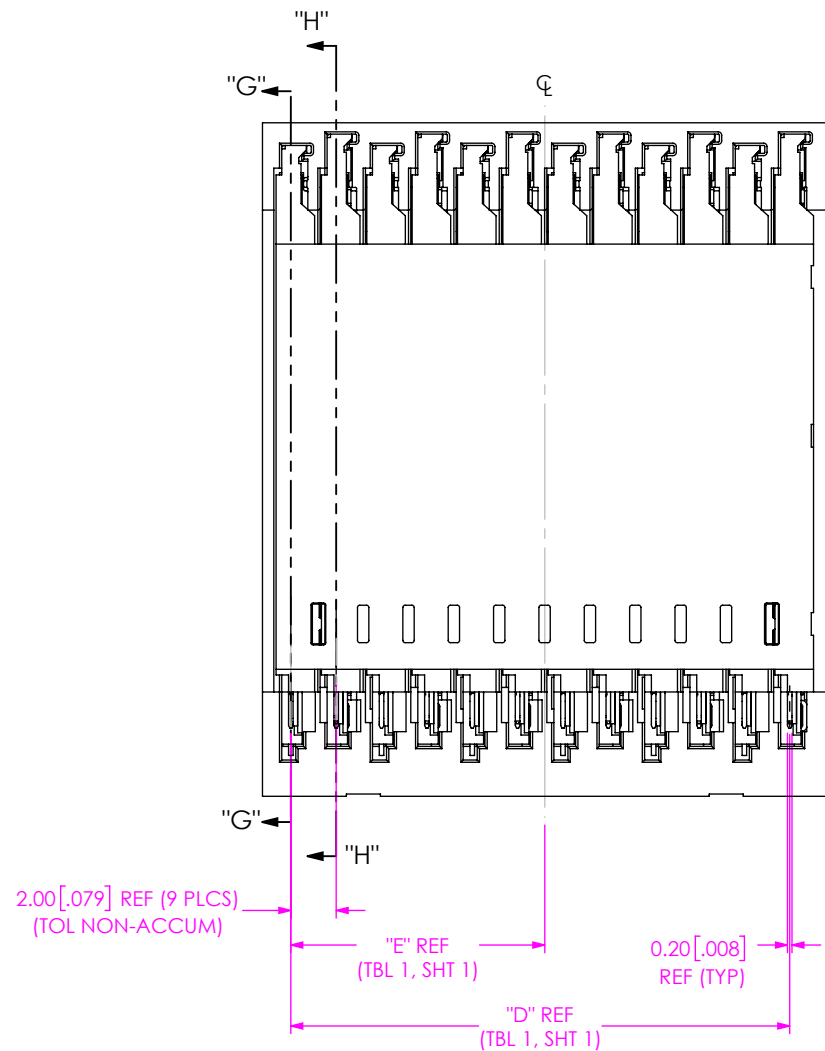

BACK VIEW

PROPRIETARY NOTE
 THIS DOCUMENT CONTAINS CONFIDENTIAL AND PROPRIETARY INFORMATION AND ALL DESIGN, MANUFACTURING, REPRODUCTION, USE, PATENT RIGHTS AND SALES RIGHTS ARE EXPRESSLY RESERVED BY SAMTEC, INC. THIS DOCUMENT SHALL NOT BE DISCLOSED, IN WHOLE OR PART, TO ANY UNAUTHORIZED PERSON OR ENTITY NOR REPRODUCED, TRANSFERRED OR INCORPORATED IN ANY OTHER PROJECT IN ANY MANNER WITHOUT THE EXPRESS WRITTEN CONSENT OF SAMTEC, INC.

DO NOT SCALE DRAWING

SHEET SCALE: 3:1



520 PARK EAST BLVD, NEW ALBANY, IN 47150
 PHONE: 812-944-6733 FAX: 812-948-5047
 e-Mail info@SAMTEC.com code 55322

DESCRIPTION:
 EXAMAX™ RIGHT ANGLE RECEPTACLE ASSEMBLY

DWG. NO.
 EBTF-6-XX-2.0-X-RA-X-X-X-X

BY: J. BROWNING 11/19/2014 SHEET 3 OF 7

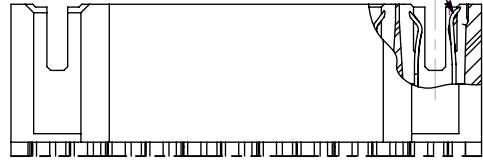
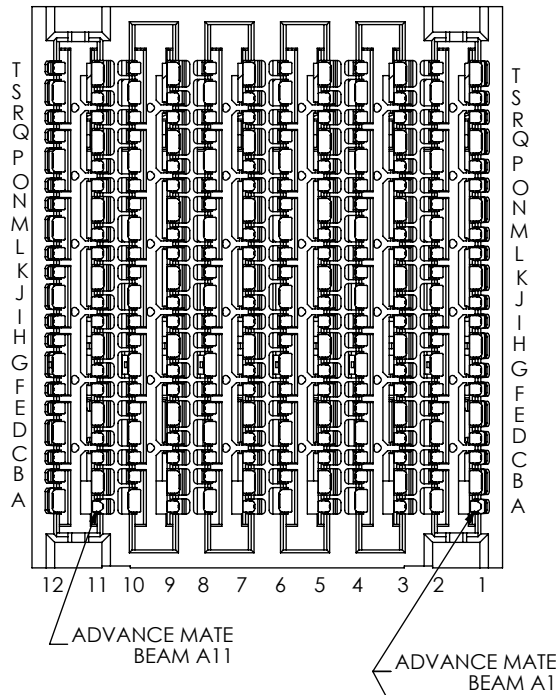

FIG 2
ADVANCED MATE
EBTF-6-12-2.0-X-RA-2 SHOWN
(DIFFERENT AS SHOWN, OTHERWISE SAME AS FIG 1)
(NOT TOOLED)

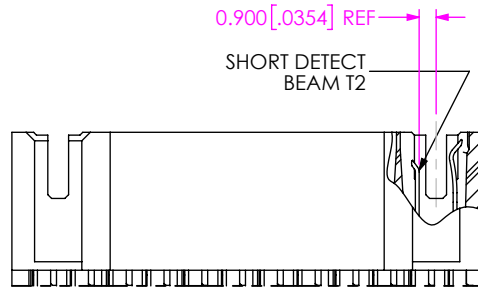
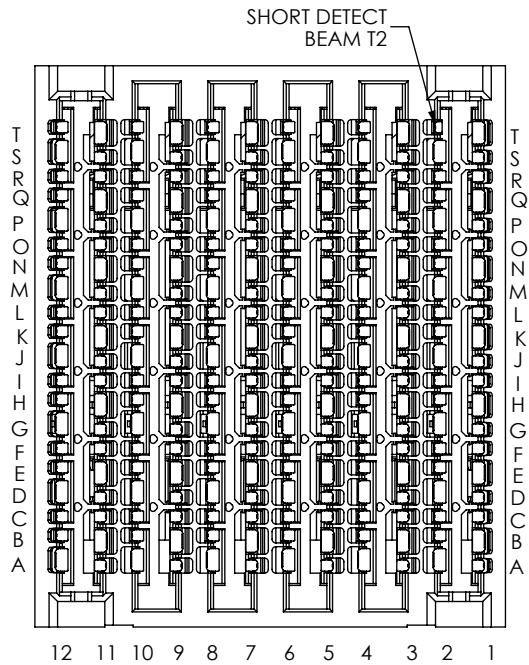

FIG 3
SHORT DETECT
EBTF-6-12-2.0-X-RA-3 SHOWN
(DIFFERENT AS SHOWN, OTHERWISE SAME AS FIG 1)
(NOT TOOLED)

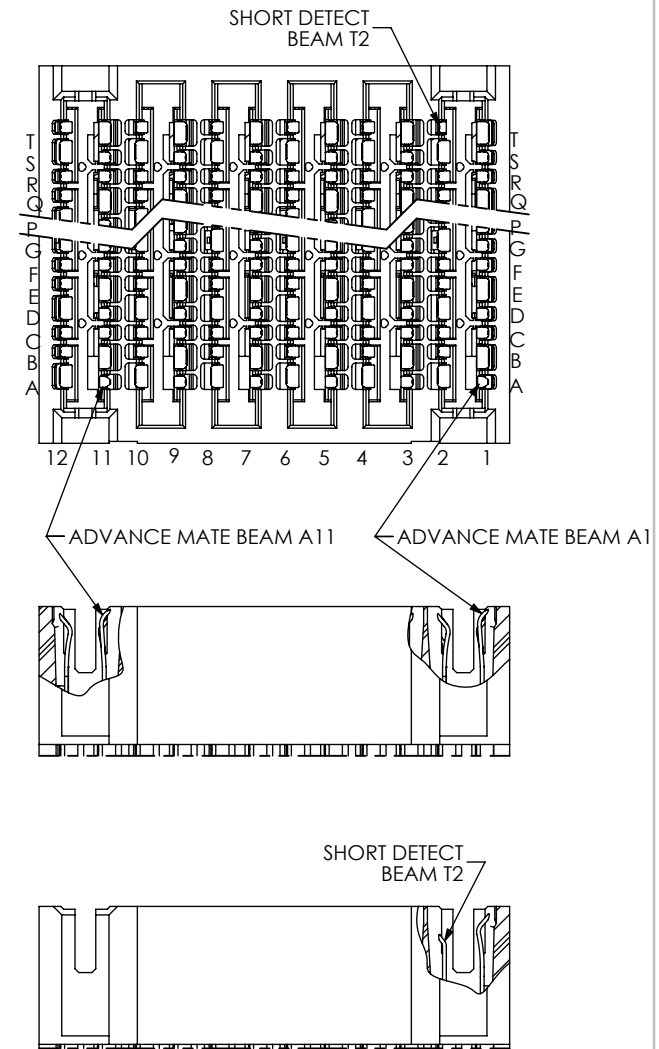

FIG 4
ADVANCED MATE AND SHORT DETECT
EBTF-6-12-2.0-X-RA-4 SHOWN
(DIFFERENT AS SHOWN, OTHERWISE SAME AS FIG 2 & 3)
(NOT TOOLED)

PROPRIETARY NOTE
THIS DOCUMENT CONTAINS CONFIDENTIAL AND PROPRIETARY INFORMATION AND ALL DESIGN, MANUFACTURING, REPRODUCTION, USE, PATENT RIGHTS AND SALES RIGHTS ARE EXPRESSLY RESERVED BY SAMTEC, INC. THIS DOCUMENT SHALL NOT BE DISCLOSED, IN WHOLE OR PART, TO ANY UNAUTHORIZED PERSON OR ENTITY NOR REPRODUCED, TRANSFERRED OR INCORPORATED IN ANY OTHER PROJECT IN ANY MANNER WITHOUT THE EXPRESS WRITTEN CONSENT OF SAMTEC, INC.

DO NOT SCALE DRAWING

SHEET SCALE: 2.5:1

samtec

520 PARK EAST BLVD, NEW ALBANY, IN 47150
PHONE: 812-944-6733 FAX: 812-948-5047
e-Mail info@SAMTEC.com code 55322

DESCRIPTION:
EXAMAX™ RIGHT ANGLE RECEPTACLE ASSEMBLY

DWG. NO.
EBTF-6-XX-2.0-X-RA-X-X-X-X

BY: J. BROWNING 11/19/2014 SHEET 4 OF 7

TABLE 2						
COLUMNS	"F"		"F" (WITH -T OPTION)		"G"	
** -06	18.85	[0.742]	18.35	[0.722]	9.20	[0.362]
** -08	22.85	[0.900]	22.35	[0.880]	11.20	[0.441]
** -10	26.85	[1.057]	26.35	[1.037]	13.20	[0.520]
-12	30.85	[1.215]	30.35	[1.195]	15.20	[0.598]

(** = NOT RELEASED)

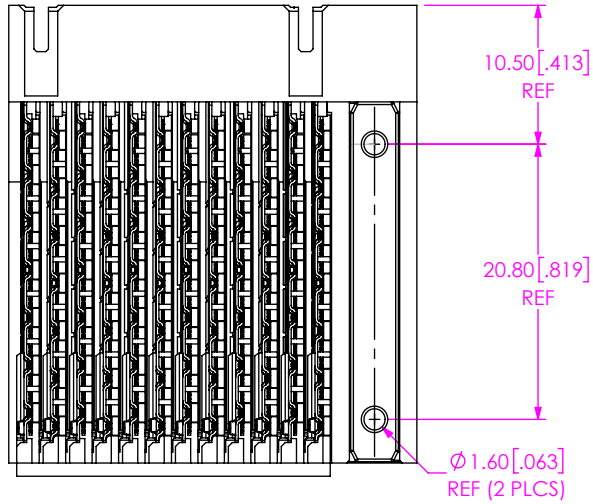
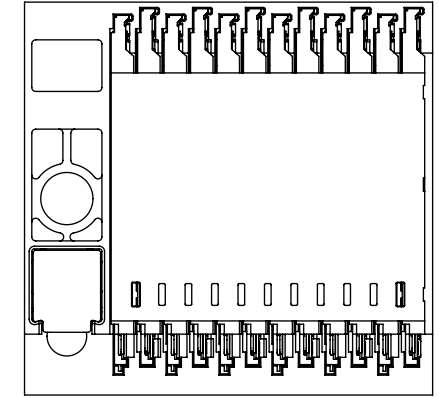
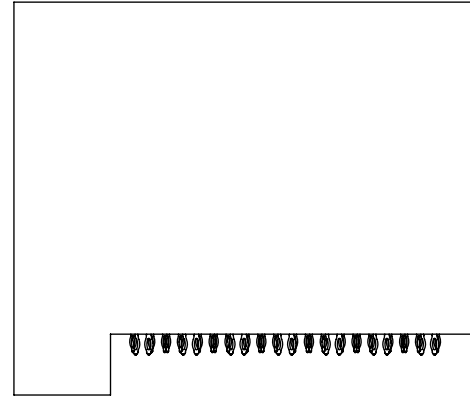
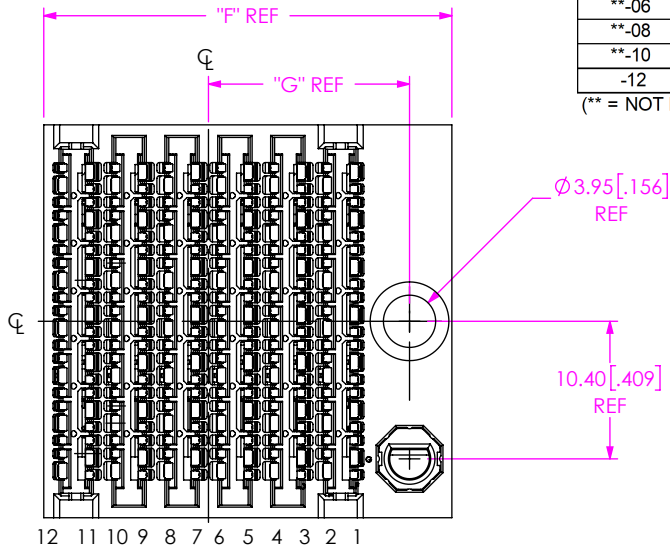

FIG 5
RIGHT GUIDANCE
EBTF-6-12-2.0-X-RA-X-R-A SHOWN
(DIFFERENT AS SHOWN, OTHERWISE SAME AS FIG 1)
(NOT RELEASED)

TABLE 1								
GUIDANCE	KEYING							
	-A	-B	-C	-D	-E	-F	-G	-H
-R / -L								

PROPRIETARY NOTE
THIS DOCUMENT CONTAINS CONFIDENTIAL AND PROPRIETARY INFORMATION AND ALL DESIGN, MANUFACTURING, REPRODUCTION, USE, PATENT RIGHTS AND SALES RIGHTS ARE EXPRESSLY RESERVED BY SAMTEC, INC. THIS DOCUMENT SHALL NOT BE DISCLOSED, IN WHOLE OR PART, TO ANY UNAUTHORIZED PERSON OR ENTITY NOR REPRODUCED, TRANSFERRED OR INCORPORATED IN ANY OTHER PROJECT IN ANY MANNER WITHOUT THE EXPRESS WRITTEN CONSENT OF SAMTEC, INC.

DO NOT SCALE DRAWING

SHEET SCALE: 1:75:1



520 PARK EAST BLVD, NEW ALBANY, IN 47150
PHONE: 812-944-6733 FAX: 812-948-5047
e-Mail info@SAMTEC.com code 55322

DESCRIPTION:
EXAMAX™ RIGHT ANGLE RECEPTACLE ASSEMBLY

DWG. NO.
EBTF-6-XX-2.0-X-RA-X-X-X-X

BY: J. BROWNING 11/19/2014 SHEET 5 OF 7

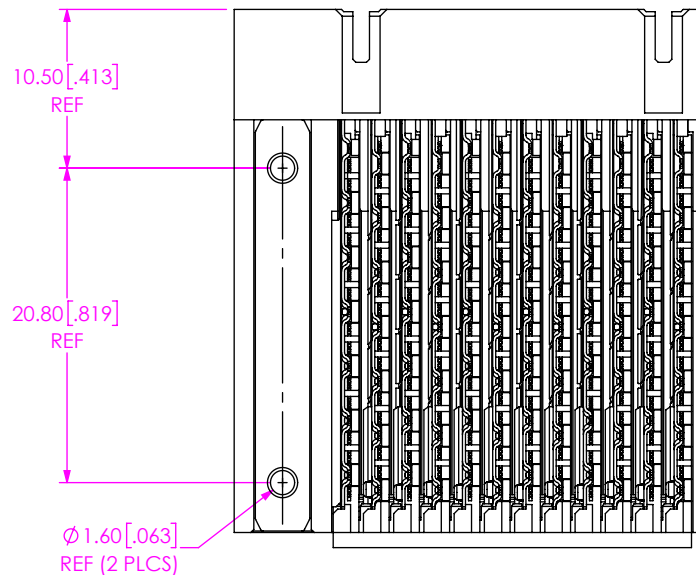
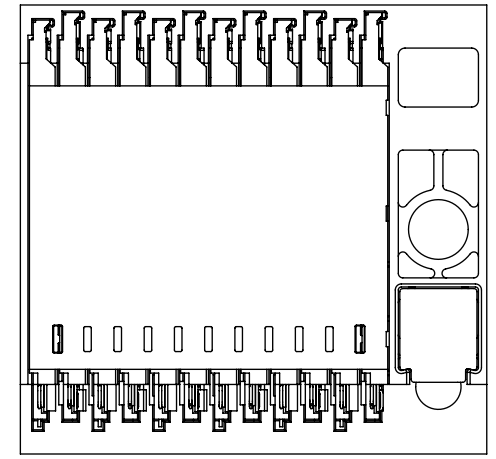
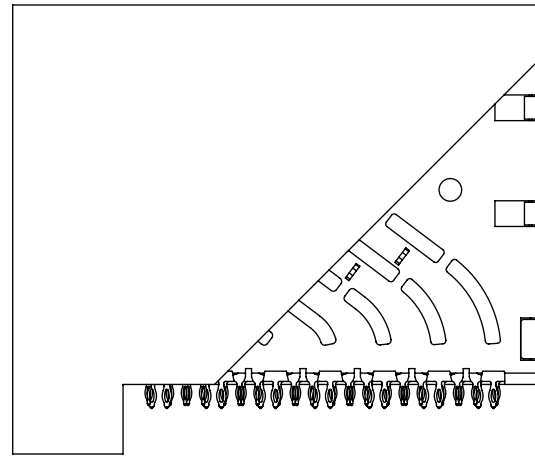
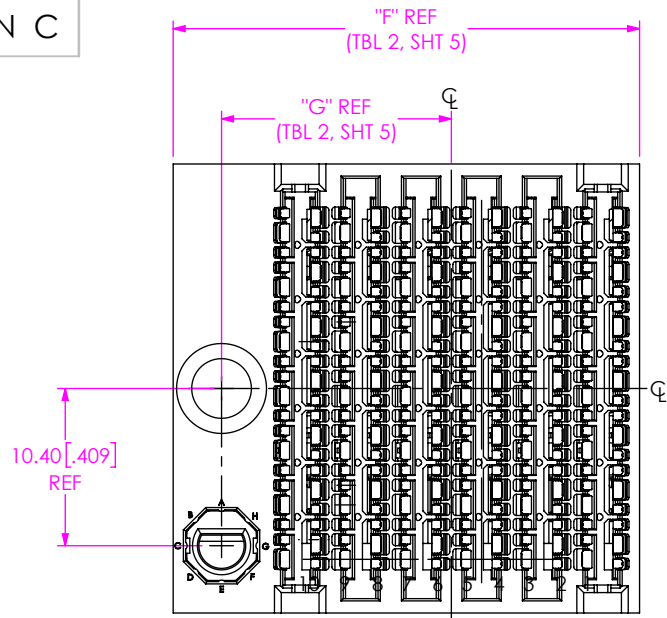

FIG 6
LEFT GUIDANCE
EBTF-6-12-2.0-X-RA-X-L-A SHOWN
(DIFFERENT AS SHOWN, OTHERWISE SAME AS FIG 5)
(NOT RELEASED)

PROPRIETARY NOTE
THIS DOCUMENT CONTAINS CONFIDENTIAL AND PROPRIETARY INFORMATION AND ALL DESIGN, MANUFACTURING, REPRODUCTION, USE, PATENT RIGHTS AND SALES RIGHTS ARE EXPRESSLY RESERVED BY SAMTEC, INC. THIS DOCUMENT SHALL NOT BE DISCLOSED, IN WHOLE OR PART, TO ANY UNAUTHORIZED PERSON OR ENTITY NOR REPRODUCED, TRANSFERRED OR INCORPORATED IN ANY OTHER PROJECT IN ANY MANNER WITHOUT THE EXPRESS WRITTEN CONSENT OF SAMTEC, INC.

DO NOT SCALE DRAWING

SHEET SCALE: 2:1

samtec

520 PARK EAST BLVD, NEW ALBANY, IN 47150
PHONE: 812-944-6733 FAX: 812-948-5047
e-Mail info@SAMTEC.com code 55322

DESCRIPTION:
EXAMAX™ RIGHT ANGLE RECEPTACLE ASSEMBLY

DWG. NO.
EBTF-6-XX-2.0-X-RA-X-X-X-X

BY: J. BROWNING 11/19/2014 SHEET 6 OF 7

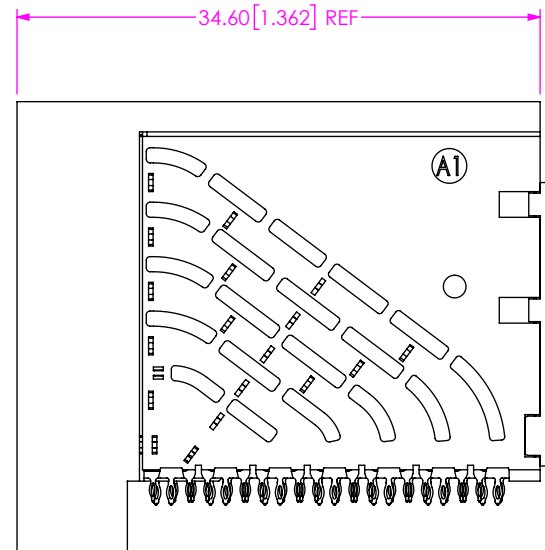
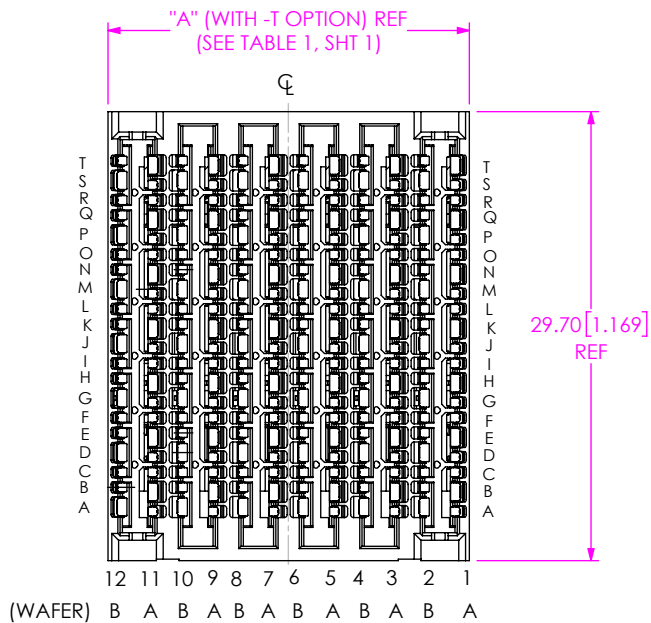
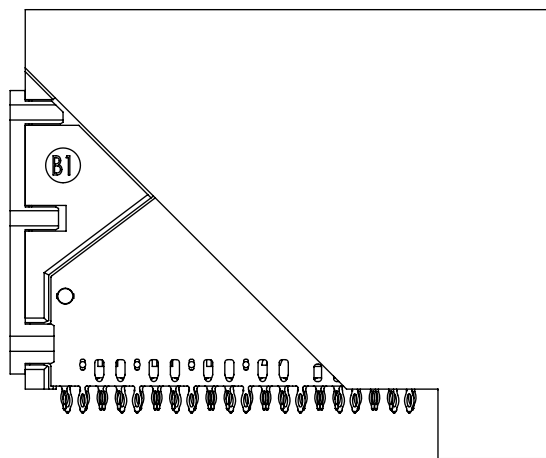
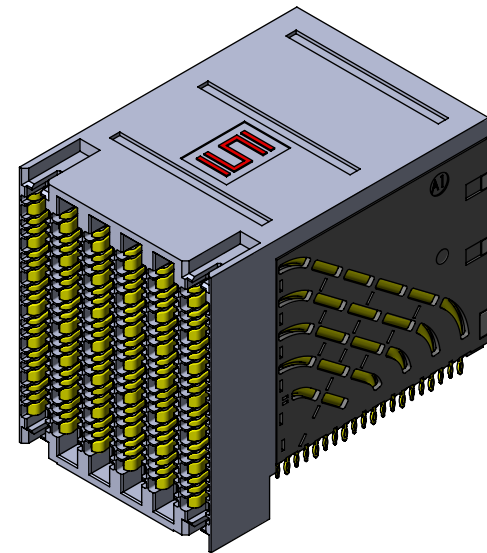
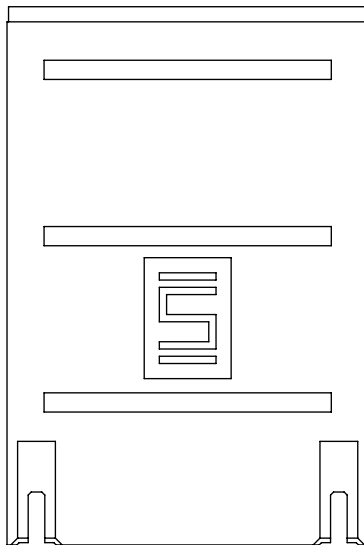

FIG 7
-T (THIN END WALLS VERSION)
EBTF-6-12-2.0-X-RA-X-T SHOWN
(DIFFERENT AS SHOWN, OTHERWISE SAME AS FIG 1)

PROPRIETARY NOTE
THIS DOCUMENT CONTAINS CONFIDENTIAL AND PROPRIETARY INFORMATION AND ALL DESIGN, MANUFACTURING, REPRODUCTION, USE, PATENT RIGHTS AND SALES RIGHTS ARE EXPRESSLY RESERVED BY SAMTEC, INC. THIS DOCUMENT SHALL NOT BE DISCLOSED, IN WHOLE OR PART, TO ANY UNAUTHORIZED PERSON OR ENTITY NOR REPRODUCED, TRANSFERRED OR INCORPORATED IN ANY OTHER PROJECT IN ANY MANNER WITHOUT THE EXPRESS WRITTEN CONSENT OF SAMTEC, INC.

samtec
520 PARK EAST BLVD, NEW ALBANY, IN 47150
PHONE: 812-944-6733 FAX: 812-948-5047
e-Mail info@SAMTEC.com code 55322

DO NOT SCALE DRAWING
SHEET SCALE: 2:1

DESCRIPTION:
EXAMAX™ RIGHT ANGLE RECEPTACLE ASSEMBLY
DWG. NO.
EBTF-6-XX-2.0-X-RA-X-X-X-X
BY: J. BROWNING 11/19/2014 SHEET 7 OF 7