

**Data sheet | Item number: 2003-6641**

Multilevel installation terminal block; with operating slots; 2.5 mm<sup>2</sup>; with pivoting knife disconnect; NTi/L/PE; Push-in CAGE CLAMP®; 2,50 mm<sup>2</sup>; gray

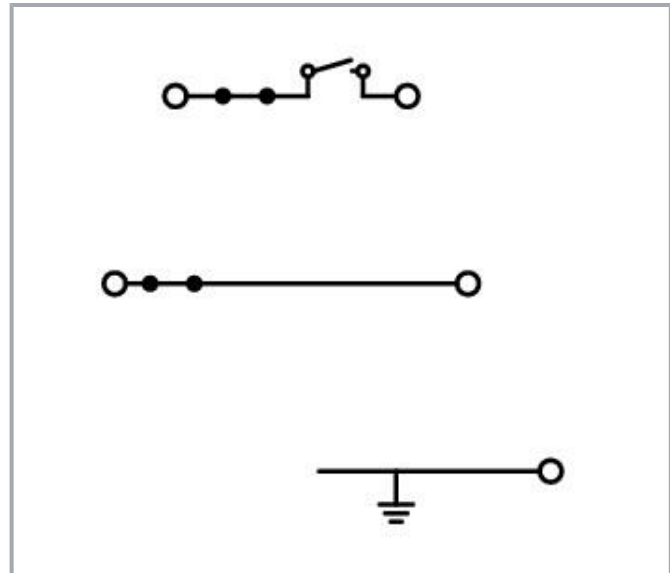

[www.wago.com/2003-6641](http://www.wago.com/2003-6641)

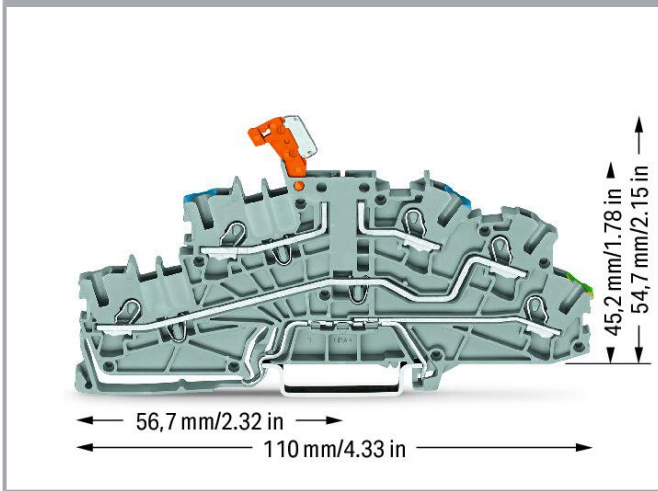
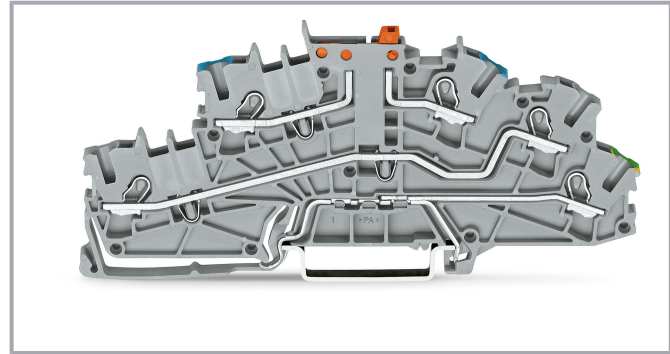
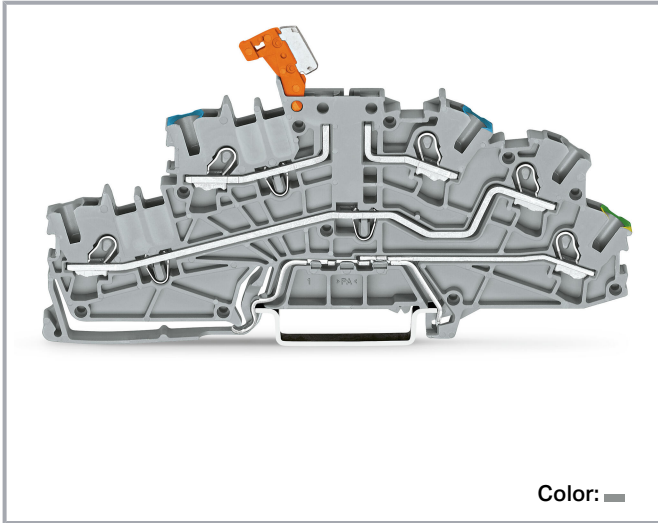

**Data**

**Electrical data**

**Ratings per IEC/EN**

Ratings per

IEC/EN 60947-7-1

Subject to changes. Please also observe the further product documentation!

WAGO GmbH & Co. KG  
Hansastr. 27  
32423 Minden  
Phone: +49571 887-0 | Fax: +49571 887-169  
Email: [info.de@wago.com](mailto:info.de@wago.com) | Web: [www.wago.com](http://www.wago.com)

Do you have any questions about our products?  
We are always happy to take your call at +49 (571) 887-44222.



Ratings (note)	Potential – ground
Nominal voltage (III/3)	250 V
Rated impulse voltage (III/3)	4 kV
Rated current	20 A
Current at conductor cross-section (max.) mm <sup>2</sup>	25 A
Legend (ratings)	(III / 3) ≙ Overvoltage category III / Pollution degree 3

### Ratings per IEC/EN 2

Ratings per 2	IEC/EN 60947-7-1
Ratings (note) 2	Potential – potential
Rated voltage (III/3) 2	400 V
Rated surge voltage (III/3) 2	6 kV
Rated current 2	20 A
Current at conductor cross-section (max.) 2	25 A

### Ratings per UL 1059

Approvals per	UL 1059
Rated voltage UL (Use Group B)	300 V
Rated current UL (Use Group B)	20 A
Rated voltage UL (Use Group C)	300 V
Rated current UL (Use Group C)	20 A
Rated voltage UL (Use Group D)	300 V
Rated current UL (Use Group D)	20 A

### Ratings per CSA

Approvals per	CSA 22.2 No 158
Rated voltage CSA (Use Group B)	300 V
Rated current CSA (Use Group B)	20 A
Rated voltage CSA (Use Group D)	150 V
Rated current CSA (Use Group D)	15 A
Rated voltage CSA (Use Group D)	300 V
Rated current CSA (Use Group D)	10 A

### Power loss

Power loss, per pole (potential)	0.532 W
Rated current $I_N$ for specified power loss	20 A

Subject to changes. Please also observe the further product documentation!



Resistance value for specified, current-dependent power loss	0.001 Ω
--	---------

### Connection data

Connection points	5
Total number of potentials	3
Number of levels	3

### Connection 1

Connection technology	Push-in CAGE CLAMP®
Actuation type	Operating tool
Connectable conductor materials	Copper
Nominal cross-section	2.5 mm <sup>2</sup>
Solid conductor	0.25 ... 4 mm <sup>2</sup> / 22 ... 12 AWG
Solid conductor; push-in termination	0.75 ... 4 mm <sup>2</sup> / 18 ... 12 AWG
Fine-stranded conductor	0.25 ... 4 mm <sup>2</sup> / 22 ... 12 AWG
Fine-stranded conductor; with insulated ferrule	0.25 ... 2.5 mm <sup>2</sup> / 22 ... 14 AWG
Fine-stranded conductor; with ferrule; push-in termination	1 ... 2.5 mm <sup>2</sup> / 18 ... 14 AWG
Note (conductor cross-section)	Depending on the conductor characteristic, a conductor with a smaller cross-section can also be inserted via push-in termination.
Strip length	10 ... 12 mm / 0.39 ... 0.47 inches
Wiring direction	Front-entry wiring

### Physical data

Width	5.2 mm / 0.205 inches
Height	110 mm / 4.331 inches
Depth from upper-edge of DIN-rail	45.2 mm / 1.78 inches

### Mechanical Data

Potential marking	NTi/L/PE
Mounting type	DIN-35 rail
Marking level	Center/side marking

### Material Data

Note (material data)

Information on material specifications can be found here

Subject to changes. Please also observe the further product documentation!

Color	gray
Material group	I
Insulation material	Polyamide (PA66)
Flammability class per UL94	V0
Fire load	0.316 MJ
Weight	20.5 g

### Environmental requirements

Processing temperature	-35 ... +85 °C
Continuous operating temperature	-60 ... +105 °C

### Commercial data



Product Group	22 (TOPJOB S)
eCl@ss 10.0	27-14-11-25
eCl@ss 9.0	27-14-11-25
ETIM 8.0	EC001329
ETIM 7.0	EC001329
PU (SPU)	50 pcs
Packaging type	box
Country of origin	CN
GTIN	4050821322030
Customs tariff number	85365080900

### Environmental Product Compliance

RoHS Compliance Status	Compliant, No Exemption
------------------------	-------------------------

### Approvals / Certificates

#### General approvals

Logo	Approval	Additional Approval Text	Certificate name
	CCA DEKRA Certification B.V.	EN 60947	NTR NL-7828
	CCA DEKRA Certification B.V.	EN 60947	71-113530

Subject to changes. Please also observe the further product documentation!



CSA  
DEKRA Certification B.V.

C22.2 No. 158

70111102





UL  
Underwriters Laboratories Inc.

UL 1059

E45172

### Declarations of conformity and manufacturer's declarations

Logo	Approval	Additional Approval Text	Certificate name
	EU-Declaration of Conformity WAGO GmbH & Co. KG	-	-
	UK-Declaration of Conformity WAGO GmbH & Co. KG	-	-

### Required accessories

#### End plate

End plate



Item no.: 2003-6692  
End and intermediate plate; 0.8 mm thick; orange

[www.wago.com/2003-6692](http://www.wago.com/2003-6692)

### Optional accessories

#### Jumpers

Jumper



Item no.: 210-123  
Wire commoning chain; insulated; blue

[www.wago.com/210-123](http://www.wago.com/210-123)

Item no.: 2002-402  
Jumper; 2-way; insulated; light gray

[www.wago.com/2002-402](http://www.wago.com/2002-402)

Item no.: 2002-402/000-005  
Jumper; 2-way; insulated; red

[www.wago.com/2002-402/000-005](http://www.wago.com/2002-402/000-005)







Item no.: 2002-400  
Continuous jumper; 2-way; insulated; light gray

[www.wago.com/2002-400](http://www.wago.com/2002-400)

Subject to changes. Please also observe the further product documentation!

WAGO GmbH & Co. KG  
Hansastr. 27  
32423 Minden  
Phone: +49571 887-0 | Fax: +49571 887-169  
Email: [info.de@wago.com](mailto:info.de@wago.com) | Web: [www.wago.com](http://www.wago.com)

Do you have any questions about our products?  
We are always happy to take your call at +49 (571) 887-44222.

	<b>Item no.: 2002-403</b> Jumper; 3-way; insulated; light gray	<a href="http://www.wago.com/2002-403">www.wago.com/2002-403</a>
	<b>Item no.: 2002-404/000-005</b> Jumper; 4-way; insulated; red	<a href="http://www.wago.com/2002-404/000-005">www.wago.com/2002-404/000-005</a>
	<b>Item no.: 2002-403/000-006</b> Jumper; 3-way; insulated; blue	<a href="http://www.wago.com/2002-403/000-006">www.wago.com/2002-403/000-006</a>
	<b>Item no.: 2002-404/000-006</b> Jumper; 4-way; insulated; blue	<a href="http://www.wago.com/2002-404/000-006">www.wago.com/2002-404/000-006</a>
	<b>Item no.: 2002-403/000-005</b> Jumper; 3-way; insulated; red	<a href="http://www.wago.com/2002-403/000-005">www.wago.com/2002-403/000-005</a>
	<b>Item no.: 2002-405/000-005</b> Jumper; 5-way; insulated; red	<a href="http://www.wago.com/2002-405/000-005">www.wago.com/2002-405/000-005</a>
	<b>Item no.: 2002-402/000-006</b> Jumper; 2-way; insulated; blue	<a href="http://www.wago.com/2002-402/000-006">www.wago.com/2002-402/000-006</a>
	<b>Item no.: 2002-405/000-006</b> Jumper; 5-way; insulated; blue	<a href="http://www.wago.com/2002-405/000-006">www.wago.com/2002-405/000-006</a>
	<b>Item no.: 2002-404</b> Jumper; 4-way; insulated; light gray	<a href="http://www.wago.com/2002-404">www.wago.com/2002-404</a>
	<b>Item no.: 2002-406/000-006</b> Jumper; 6-way; insulated; blue	<a href="http://www.wago.com/2002-406/000-006">www.wago.com/2002-406/000-006</a>
	<b>Item no.: 2002-406/000-005</b> Jumper; 6-way; insulated; red	<a href="http://www.wago.com/2002-406/000-005">www.wago.com/2002-406/000-005</a>
	<b>Item no.: 2002-406/020-000</b> Delta jumper; insulated; light gray	<a href="http://www.wago.com/2002-406/020-000">www.wago.com/2002-406/020-000</a>
	<b>Item no.: 2002-405</b> Jumper; 5-way; insulated; light gray	<a href="http://www.wago.com/2002-405">www.wago.com/2002-405</a>

Subject to changes. Please also observe the further product documentation!



**Item no.: 2002-407/000-005**  
Jumper; 7-way; insulated; red

[www.wago.com/2002-407/000-005](http://www.wago.com/2002-407/000-005)



**Item no.: 2002-408**  
Jumper; 8-way; insulated; light gray

[www.wago.com/2002-408](http://www.wago.com/2002-408)



**Item no.: 2002-408/000-006**  
Jumper; 8-way; insulated; blue

[www.wago.com/2002-408/000-006](http://www.wago.com/2002-408/000-006)



**Item no.: 2002-405/011-000**  
Star point jumper; 3-way; insulated; light gray

[www.wago.com/2002-405/011-000](http://www.wago.com/2002-405/011-000)



**Item no.: 2002-407/000-006**  
Jumper; 7-way; insulated; blue

[www.wago.com/2002-407/000-006](http://www.wago.com/2002-407/000-006)



**Item no.: 2002-408/000-005**  
Jumper; 8-way; insulated; red

[www.wago.com/2002-408/000-005](http://www.wago.com/2002-408/000-005)



**Item no.: 2002-407**  
Jumper; 7-way; insulated; light gray

[www.wago.com/2002-407](http://www.wago.com/2002-407)



**Item no.: 2002-406**  
Jumper; 6-way; insulated; light gray

[www.wago.com/2002-406](http://www.wago.com/2002-406)



**Item no.: 2002-410/000-005**  
Jumper; 10-way; insulated; red

[www.wago.com/2002-410/000-005](http://www.wago.com/2002-410/000-005)



**Item no.: 2002-410/000-006**  
Jumper; 10-way; insulated; blue

[www.wago.com/2002-410/000-006](http://www.wago.com/2002-410/000-006)



**Item no.: 2002-410**  
Jumper; 10-way; insulated; light gray

[www.wago.com/2002-410](http://www.wago.com/2002-410)



**Item no.: 2002-409/000-006**  
Jumper; 9-way; insulated; blue

[www.wago.com/2002-409/000-006](http://www.wago.com/2002-409/000-006)

Subject to changes. Please also observe the further product documentation!



**Item no.: 2002-409/000-005**  
Jumper; 9-way; insulated; red

[www.wago.com/2002-409/000-005](http://www.wago.com/2002-409/000-005)



**Item no.: 2002-409**  
Jumper; 9-way; insulated; light gray

[www.wago.com/2002-409](http://www.wago.com/2002-409)



**Item no.: 2002-423/000-006**  
Continuous jumper; from 1 to 3; insulated; blue

[www.wago.com/2002-423/000-006](http://www.wago.com/2002-423/000-006)



**Item no.: 2002-423**  
Continuous jumper; from 1 to 3; insulated; light gray

[www.wago.com/2002-423](http://www.wago.com/2002-423)



**Item no.: 2002-433**  
Jumper; from 1 to 3; insulated; light gray

[www.wago.com/2002-433](http://www.wago.com/2002-433)



**Item no.: 2002-434**  
Jumper; from 1 to 4; insulated; light gray

[www.wago.com/2002-434](http://www.wago.com/2002-434)



**Item no.: 2002-423/000-005**  
Continuous jumper; from 1 to 3; insulated; red

[www.wago.com/2002-423/000-005](http://www.wago.com/2002-423/000-005)



**Item no.: 2002-435**  
Jumper; from 1 to 5; insulated; light gray

[www.wago.com/2002-435](http://www.wago.com/2002-435)



**Item no.: 2002-436**  
Jumper; from 1 to 6; insulated; light gray

[www.wago.com/2002-436](http://www.wago.com/2002-436)



**Item no.: 2002-437**  
Jumper; from 1 to 7; insulated; light gray

[www.wago.com/2002-437](http://www.wago.com/2002-437)



**Item no.: 2002-438**  
Jumper; from 1 to 8; insulated; light gray

[www.wago.com/2002-438](http://www.wago.com/2002-438)



**Item no.: 2002-439**  
Jumper; from 1 to 9; insulated; light gray

[www.wago.com/2002-439](http://www.wago.com/2002-439)



**Item no.: 2002-440**  
Jumper; from 1 to 10; insulated; light gray

[www.wago.com/2002-440](http://www.wago.com/2002-440)



**Item no.: 2002-472**  
Staggered jumper; 2-way; insulated; light gray

[www.wago.com/2002-472](http://www.wago.com/2002-472)



**Item no.: 2002-473**  
Staggered jumper; 3-way; insulated; light gray

[www.wago.com/2002-473](http://www.wago.com/2002-473)

















**Item no.: 2002-475/011-000**  
Staggered jumper; 3-way; insulated; light gray

[www.wago.com/2002-475/011-000](http://www.wago.com/2002-475/011-000)

Subject to changes. Please also observe the further product documentation!







	<b>Item no.: 2002-475</b> Staggered jumper; 5-way; insulated; light gray	<a href="http://www.wago.com/2002-475">www.wago.com/2002-475</a>
	<b>Item no.: 2002-476</b> Staggered jumper; 6-way; insulated; light gray	<a href="http://www.wago.com/2002-476">www.wago.com/2002-476</a>
	<b>Item no.: 2002-474</b> Staggered jumper; 4-way; insulated; light gray	<a href="http://www.wago.com/2002-474">www.wago.com/2002-474</a>
	<b>Item no.: 2002-477</b> Staggered jumper; 7-way; insulated; light gray	<a href="http://www.wago.com/2002-477">www.wago.com/2002-477</a>
	<b>Item no.: 2002-473/011-000</b> Staggered jumper; 2-way; from 1 to 3; insulated; light gray	<a href="http://www.wago.com/2002-473/011-000">www.wago.com/2002-473/011-000</a>
	<b>Item no.: 2002-479</b> Staggered jumper; 9-way; insulated; light gray	<a href="http://www.wago.com/2002-479">www.wago.com/2002-479</a>
	<b>Item no.: 2002-478</b> Staggered jumper; 8-way; insulated; light gray	<a href="http://www.wago.com/2002-478">www.wago.com/2002-478</a>
	<b>Item no.: 2002-479/011-000</b> Staggered jumper; insulated; light gray	<a href="http://www.wago.com/2002-479/011-000">www.wago.com/2002-479/011-000</a>
	<b>Item no.: 2002-480</b> Staggered jumper; 10-way; insulated; light gray	<a href="http://www.wago.com/2002-480">www.wago.com/2002-480</a>
	<b>Item no.: 2002-477/011-000</b> Staggered jumper; insulated; light gray	<a href="http://www.wago.com/2002-477/011-000">www.wago.com/2002-477/011-000</a>
	<b>Item no.: 2002-481/011-000</b> Staggered jumper; insulated; light gray	<a href="http://www.wago.com/2002-481/011-000">www.wago.com/2002-481/011-000</a>
	<b>Item no.: 2002-481</b> Staggered jumper; 11-way; insulated; light gray	<a href="http://www.wago.com/2002-481">www.wago.com/2002-481</a>
	<b>Item no.: 2002-482</b> Staggered jumper; 12-way; insulated; light gray	<a href="http://www.wago.com/2002-482">www.wago.com/2002-482</a>
	<b>Item no.: 210-103</b> Wire commoning chain; insulated; black	<a href="http://www.wago.com/210-103">www.wago.com/210-103</a>
	<b>Item no.: 2002-424/000-006</b> Continuous jumper; from 1 to 4; insulated; blue	<a href="http://www.wago.com/2002-424/000-006">www.wago.com/2002-424/000-006</a>

Subject to changes. Please also observe the further product documentation!





## Testing and measuring

### Testing accessories

	<b>Item no.: 2009-174</b> Test plug adapter; for 4 mm Ø test plugs; for testing TOPJOB®S rail-mounted terminal blocks; gray	<a href="http://www.wago.com/2009-174">www.wago.com/2009-174</a>
	<b>Item no.: 2009-182</b> Testing tap; for max. 2.5 mm <sup>2</sup> ; tool-free connection for individual test wires 0.08 - 2.5 mm; gray	<a href="http://www.wago.com/2009-182">www.wago.com/2009-182</a>
	<b>Item no.: 2003-499</b> Test plug adapter N/L; for 2003-6641 and 2003-6640 Multilevel Installation Terminal Blocks; for vertical test slot; 2-pole; gray	<a href="http://www.wago.com/2003-499">www.wago.com/2003-499</a>
	<b>Item no.: 2003-500</b> Test plug adapter N; for 2003-6641 and 2003-6640 Multilevel Installation Terminal Blocks; for vertical test slot; 1-pole; gray	<a href="http://www.wago.com/2003-500">www.wago.com/2003-500</a>
	<b>Item no.: 210-136</b> Test plug; 2 mm Ø; with 500 mm cable; red	<a href="http://www.wago.com/210-136">www.wago.com/210-136</a>



## Tool

### Operating tool

	<b>Item no.: 2009-310</b> Operating tool; Blades: 3.5 x 0.5 mm and 5.5 x 0.8 mm; for TOPJOB®S installation terminal blocks; green	<a href="http://www.wago.com/2009-310">www.wago.com/2009-310</a>
	<b>Item no.: 2009-309</b> Operating tool; Blades: 3.5 x 0.5 mm and 2.5 x 0.4 mm; for TOPJOB®S installation terminal blocks	<a href="http://www.wago.com/2009-309">www.wago.com/2009-309</a>
	<b>Item no.: 210-658</b> Operating tool; Blade: 3.5 x 0.5 mm; with a partially insulated shaft; angled; short; multicoloured	<a href="http://www.wago.com/210-658">www.wago.com/210-658</a>
	<b>Item no.: 210-720</b> Operating tool; Blade: 3.5 x 0.5 mm; with a partially insulated shaft; multicoloured	<a href="http://www.wago.com/210-720">www.wago.com/210-720</a>

## Ferrule

### Ferrule

	<b>Item no.: 216-241</b> Ferrule; Sleeve for 0.5 mm <sup>2</sup> / 20 AWG; insulated; electro-tin plated; electrolytic copper; gastight crimped; acc. to DIN 46228, Part 4/09.90; white	<a href="http://www.wago.com/216-241">www.wago.com/216-241</a>
	<b>Item no.: 216-242</b> Ferrule; Sleeve for 0.75 mm <sup>2</sup> / 18 AWG; insulated; electro-tin plated; electrolytic copper; gastight crimped; acc. to DIN 46228, Part 4/09.90; gray	<a href="http://www.wago.com/216-242">www.wago.com/216-242</a>
	<b>Item no.: 216-243</b> Ferrule; Sleeve for 1 mm <sup>2</sup> / AWG 18; insulated; electro-tin plated; electrolytic copper; gastight crimped;	<a href="http://www.wago.com/216-243">www.wago.com/216-243</a>

Subject to changes. Please also observe the further product documentation!

acc. to DIN 46228, Part 4/09.90; red



**Item no.: 216-244**

Ferrule; Sleeve for 1.5 mm<sup>2</sup> / AWG 16; insulated; electro-tin plated; electrolytic copper; gastight crimped; acc. to DIN 46228, Part 4/09.90; black

[www.wago.com/216-244](http://www.wago.com/216-244)



**Item no.: 216-263**

Ferrule; Sleeve for 1 mm<sup>2</sup> / AWG 18; insulated; electro-tin plated; electrolytic copper; gastight crimped; acc. to DIN 46228, Part 4/09.90; red

[www.wago.com/216-263](http://www.wago.com/216-263)



**Item no.: 216-246**

Ferrule; Sleeve for 2.5 mm<sup>2</sup> / AWG 14; insulated; electro-tin plated; electrolytic copper; gastight crimped; acc. to DIN 46228, Part 4/09.90; blue

[www.wago.com/216-246](http://www.wago.com/216-246)



**Item no.: 216-266**

Ferrule; Sleeve for 2.5 mm<sup>2</sup> / AWG 14; insulated; electro-tin plated; electrolytic copper; gastight crimped; acc. to DIN 46228, Part 4/09.90; blue

[www.wago.com/216-266](http://www.wago.com/216-266)



**Item no.: 216-264**

Ferrule; Sleeve for 1.5 mm<sup>2</sup> / AWG 16; insulated; electro-tin plated; electrolytic copper; gastight crimped; acc. to DIN 46228, Part 4/09.90; black

[www.wago.com/216-264](http://www.wago.com/216-264)



**Item no.: 216-262**

Ferrule; Sleeve for 0.75 mm<sup>2</sup> / 18 AWG; insulated; electro-tin plated; electrolytic copper; gastight crimped; acc. to DIN 46228, Part 4/09.90; gray

[www.wago.com/216-262](http://www.wago.com/216-262)

**Insulation stop**

Insulation stop



**Item no.: 2002-171**

Insulation stop; 0.25 - 0.5 mm<sup>2</sup>; 5 pieces/strip; light gray

[www.wago.com/2002-171](http://www.wago.com/2002-171)



**Item no.: 2002-172**

Insulation stop; 0.75 - 1 mm<sup>2</sup>; 5 pieces/strip; dark gray

[www.wago.com/2002-172](http://www.wago.com/2002-172)

**Mounting**

Cover carrier



**Item no.: 709-169**

Cover carrier; Type 3; gray

[www.wago.com/709-169](http://www.wago.com/709-169)

Cover



**Item no.: 709-156**

Cover; Type 3; suitable for cover carrier, type 3; 1 m long; transparent

[www.wago.com/709-156](http://www.wago.com/709-156)

Mounting accessories



**Item no.: 2009-305**

Busbar carrier; with end stop function and detachable separator plate; for DIN 35 rail; 7.5 mm thick; blue

[www.wago.com/2009-305](http://www.wago.com/2009-305)



**Item no.: 2009-304**

Busbar carrier; not suitable for use as end stop; for DIN 35 rail; 1.5 mm thick; blue

[www.wago.com/2009-304](http://www.wago.com/2009-304)

**Marking accessories**

Marking strip

Subject to changes. Please also observe the further product documentation!

WAGO GmbH & Co. KG

Hansastr. 27













32423 Minden

Phone: +49571 887-0 | Fax: +49571 887-169











Email: [info.de@wago.com](mailto:info.de@wago.com) | Web: [www.wago.com](http://www.wago.com)

Do you have any questions about our products?

We are always happy to take your call at +49 (571) 887-44222.

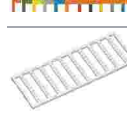
	<b>Item no.: 2009-110</b> Marking strips; for Smart Printer; on reel; not stretchable; plain; snap-on type; white	<a href="http://www.wago.com/2009-110">www.wago.com/2009-110</a>
Marker carrier		
	<b>Item no.: 2009-198</b> Adaptor; gray	<a href="http://www.wago.com/2009-198">www.wago.com/2009-198</a>
Marker		
	<b>Item no.: 2009-115/000-002</b> WMB-Inline; for Smart Printer; 1500 pieces on roll; stretchable 5 - 5.2 mm; plain; snap-on type; yellow	<a href="http://www.wago.com/2009-115/000-002">www.wago.com/2009-115/000-002</a>
	<b>Item no.: 2009-115/000-007</b> WMB-Inline; for Smart Printer; 1500 pieces on roll; stretchable 5 - 5.2 mm; plain; snap-on type; gray	<a href="http://www.wago.com/2009-115/000-007">www.wago.com/2009-115/000-007</a>
	<b>Item no.: 2009-115/000-017</b> WMB-Inline; for Smart Printer; 1500 pieces on roll; stretchable 5 - 5.2 mm; plain; snap-on type; light green	<a href="http://www.wago.com/2009-115/000-017">www.wago.com/2009-115/000-017</a>
	<b>Item no.: 2009-115/000-023</b> WMB-Inline; for Smart Printer; 1500 pieces on roll; stretchable 5 - 5.2 mm; plain; snap-on type; green	<a href="http://www.wago.com/2009-115/000-023">www.wago.com/2009-115/000-023</a>
	<b>Item no.: 2009-115/000-024</b> WMB-Inline; for Smart Printer; 1500 pieces on roll; stretchable 5 - 5.2 mm; plain; snap-on type; violet	<a href="http://www.wago.com/2009-115/000-024">www.wago.com/2009-115/000-024</a>
	<b>Item no.: 2009-145/000-006</b> Mini-WSB Inline; for Smart Printer; 1700 pieces on roll; stretchable 5 - 5.2 mm; plain; snap-on type; blue	<a href="http://www.wago.com/2009-145/000-006">www.wago.com/2009-145/000-006</a>
	<b>Item no.: 2009-145</b> Mini-WSB Inline; for Smart Printer; 1700 pieces on roll; stretchable 5 - 5.2 mm; plain; snap-on type; white	<a href="http://www.wago.com/2009-145">www.wago.com/2009-145</a>
	<b>Item no.: 2009-145/000-002</b> Mini-WSB Inline; for Smart Printer; 1700 pieces on roll; stretchable 5 - 5.2 mm; plain; snap-on type; yellow	<a href="http://www.wago.com/2009-145/000-002">www.wago.com/2009-145/000-002</a>
	<b>Item no.: 2009-145/000-007</b> Mini-WSB Inline; for Smart Printer; 1700 pieces on roll; stretchable 5 - 5.2 mm; plain; snap-on type; gray	<a href="http://www.wago.com/2009-145/000-007">www.wago.com/2009-145/000-007</a>
	<b>Item no.: 2009-145/000-005</b> Mini-WSB Inline; for Smart Printer; 1700 pieces on roll; stretchable 5 - 5.2 mm; plain; snap-on type; red	<a href="http://www.wago.com/2009-145/000-005">www.wago.com/2009-145/000-005</a>
	<b>Item no.: 2009-145/000-012</b> Mini-WSB Inline; for Smart Printer; 1700 pieces on roll; stretchable 5 - 5.2 mm; plain; snap-on type; orange	<a href="http://www.wago.com/2009-145/000-012">www.wago.com/2009-145/000-012</a>

Subject to changes. Please also observe the further product documentation!

	<b>Item no.: 2009-145/000-023</b> Mini-WSB Inline; for Smart Printer; 1700 pieces on roll; stretchable 5 - 5.2 mm; plain; snap-on type; green	<a href="http://www.wago.com/2009-145/000-023">www.wago.com/2009-145/000-023</a>
	<b>Item no.: 2009-145/000-024</b> Mini-WSB Inline; for Smart Printer; 1700 pieces on roll; stretchable 5 - 5.2 mm; plain; snap-on type; violet	<a href="http://www.wago.com/2009-145/000-024">www.wago.com/2009-145/000-024</a>
	<b>Item no.: 2009-115</b> WMB-Inline; for Smart Printer; 1500 pieces on roll; stretchable 5 - 5.2 mm; plain; snap-on type; white	<a href="http://www.wago.com/2009-115">www.wago.com/2009-115</a>
	<b>Item no.: 248-501/000-006</b> Mini-WSB marking card; as card; not stretchable; plain; snap-on type; blue	<a href="http://www.wago.com/248-501/000-006">www.wago.com/248-501/000-006</a>
	<b>Item no.: 248-501/000-007</b> Mini-WSB marking card; as card; not stretchable; plain; snap-on type; gray	<a href="http://www.wago.com/248-501/000-007">www.wago.com/248-501/000-007</a>
	<b>Item no.: 248-501/000-002</b> Mini-WSB marking card; as card; not stretchable; plain; snap-on type; yellow	<a href="http://www.wago.com/248-501/000-002">www.wago.com/248-501/000-002</a>
	<b>Item no.: 248-501/000-012</b> Mini-WSB marking card; as card; not stretchable; plain; snap-on type; orange	<a href="http://www.wago.com/248-501/000-012">www.wago.com/248-501/000-012</a>
	<b>Item no.: 248-501</b> Mini-WSB marking card; as card; not stretchable; plain; snap-on type; white	<a href="http://www.wago.com/248-501">www.wago.com/248-501</a>
	<b>Item no.: 248-501/000-017</b> Mini-WSB marking card; as card; not stretchable; plain; snap-on type; light green	<a href="http://www.wago.com/248-501/000-017">www.wago.com/248-501/000-017</a>
	<b>Item no.: 248-501/000-005</b> Mini-WSB marking card; as card; not stretchable; plain; snap-on type; red	<a href="http://www.wago.com/248-501/000-005">www.wago.com/248-501/000-005</a>
	<b>Item no.: 248-501/000-024</b> Mini-WSB marking card; as card; not stretchable; plain; snap-on type; violet	<a href="http://www.wago.com/248-501/000-024">www.wago.com/248-501/000-024</a>
	<b>Item no.: 248-501/000-023</b> Mini-WSB marking card; as card; not stretchable; plain; snap-on type; green	<a href="http://www.wago.com/248-501/000-023">www.wago.com/248-501/000-023</a>

Subject to changes. Please also observe the further product documentation!



**Item no.:** 793-5501/000-007

WMB marking card; as card; for terminal block width 5 - 17.5 mm; stretchable 5 - 5.2 mm; plain; snap-on type; gray [www.wago.com/793-5501/000-007](http://www.wago.com/793-5501/000-007)



**Item no.:** 793-5501/000-012

WMB marking card; as card; for terminal block width 5 - 17.5 mm; stretchable 5 - 5.2 mm; plain; snap-on type; orange [www.wago.com/793-5501/000-012](http://www.wago.com/793-5501/000-012)



**Item no.:** 793-5501/000-014

WMB marking card; as card; for terminal block width 5 - 17.5 mm; stretchable 5 - 5.2 mm; plain; snap-on type; brown [www.wago.com/793-5501/000-014](http://www.wago.com/793-5501/000-014)



**Item no.:** 793-5501/000-017

WMB marking card; as card; for terminal block width 5 - 17.5 mm; stretchable 5 - 5.2 mm; plain; snap-on type; light green [www.wago.com/793-5501/000-017](http://www.wago.com/793-5501/000-017)



**Item no.:** 793-5501/000-023

WMB marking card; as card; for terminal block width 5 - 17.5 mm; stretchable 5 - 5.2 mm; plain; snap-on type; green [www.wago.com/793-5501/000-023](http://www.wago.com/793-5501/000-023)



**Item no.:** 793-5501/000-024

WMB marking card; as card; for terminal block width 5 - 17.5 mm; stretchable 5 - 5.2 mm; plain; snap-on type; violet [www.wago.com/793-5501/000-024](http://www.wago.com/793-5501/000-024)



**Item no.:** 793-5501/000-005

WMB marking card; as card; for terminal block width 5 - 17.5 mm; stretchable 5 - 5.2 mm; plain; snap-on type; red [www.wago.com/793-5501/000-005](http://www.wago.com/793-5501/000-005)



**Item no.:** 793-5501/000-002

WMB marking card; as card; for terminal block width 5 - 17.5 mm; stretchable 5 - 5.2 mm; plain; snap-on type; yellow [www.wago.com/793-5501/000-002](http://www.wago.com/793-5501/000-002)



**Item no.:** 793-5501/000-006

WMB marking card; as card; for terminal block width 5 - 17.5 mm; stretchable 5 - 5.2 mm; plain; snap-on type; blue [www.wago.com/793-5501/000-006](http://www.wago.com/793-5501/000-006)



**Item no.:** 793-5501

WMB marking card; as card; for terminal block width 5 - 17.5 mm; stretchable 5 - 5.2 mm; plain; snap-on type; white [www.wago.com/793-5501](http://www.wago.com/793-5501)



**Item no.:** 2009-115/000-012

WMB-Inline; for Smart Printer; 1500 pieces on roll; stretchable 5 - 5.2 mm; plain; snap-on type; orange [www.wago.com/2009-115/000-012](http://www.wago.com/2009-115/000-012)

Subject to changes. Please also observe the further product documentation!

	<b>Item no.: 2009-115/000-006</b> WMB-Inline; for Smart Printer; 1500 pieces on roll; stretchable 5 - 5.2 mm; plain; snap-on type; blue	<a href="http://www.wago.com/2009-115/000-006">www.wago.com/2009-115/000-006</a>
---	--	--

	<b>Item no.: 2009-115/000-005</b> WMB-Inline; for Smart Printer; 1500 pieces on roll; stretchable 5 - 5.2 mm; plain; snap-on type; red	<a href="http://www.wago.com/2009-115/000-005">www.wago.com/2009-115/000-005</a>
---	---	--

Group marker carrier

	<b>Item no.: 2009-193</b> Group marker carrier; gray	<a href="http://www.wago.com/2009-193">www.wago.com/2009-193</a>
--	---	--

	<b>Item no.: 2009-192</b> Group marker carrier; gray	<a href="http://www.wago.com/2009-192">www.wago.com/2009-192</a>
--	---	--

	<b>Item no.: 2009-191</b> Group marker carrier; gray	<a href="http://www.wago.com/2009-191">www.wago.com/2009-191</a>
--	---	--

Carrier rail

Mounting accessories

	<b>Item no.: 210-197</b> Steel carrier rail; 35 x 15 mm; 1.5 mm thick; 2 m long; slotted; similar to EN 60715; silver-colored	<a href="http://www.wago.com/210-197">www.wago.com/210-197</a>
--	--	--

	<b>Item no.: 210-198</b> Copper carrier rail; 35 x 15 mm; 2.3 mm thick; 2 m long; unslotted; according to EN 60715; copper-colored	<a href="http://www.wago.com/210-198">www.wago.com/210-198</a>
--	---	--

	<b>Item no.: 210-113</b> Steel carrier rail; 35 x 7.5 mm; 1 mm thick; 2 m long; unslotted; according to EN 60715; silver-colored	<a href="http://www.wago.com/210-113">www.wago.com/210-113</a>
--	---	--

	<b>Item no.: 210-118</b> Steel carrier rail; 35 x 15 mm; 2.3 mm thick; 2 m long; unslotted; according to EN 60715; silver-colored	<a href="http://www.wago.com/210-118">www.wago.com/210-118</a>
--	--	--

	<b>Item no.: 210-112</b> Steel carrier rail; 35 x 7.5 mm; 1 mm thick; 2 m long; slotted; according to EN 60715; "Hole width 25 mm; silver-colored	<a href="http://www.wago.com/210-112">www.wago.com/210-112</a>
--	--	--

	<b>Item no.: 210-114</b> Steel carrier rail; 35 x 15 mm; 1.5 mm thick; 2 m long; unslotted; similar to EN 60715; silver-colored	<a href="http://www.wago.com/210-114">www.wago.com/210-114</a>
--	--	--

	<b>Item no.: 210-115</b> Steel carrier rail; 35 x 7.5 mm; 1 mm thick; 2 m long; slotted; according to EN 60715; "Hole width 18 mm; silver-colored	<a href="http://www.wago.com/210-115">www.wago.com/210-115</a>
--	--	--





	<b>Item no.: 210-196</b> Aluminum carrier rail; 35 x 8.2 mm; 1.6 mm thick; 2 m long; unslotted; similar to EN 60715; silver-colored	<a href="http://www.wago.com/210-196">www.wago.com/210-196</a>
--	--	--

Push-in type wire jumper

Jumper

	<b>Item no.: 2009-412</b> Push-in type wire jumper; insulated; 60 mm long; black	<a href="http://www.wago.com/2009-412">www.wago.com/2009-412</a>
--	---	--

Subject to changes. Please also observe the further product documentation!

	<b>Item no.: 2009-414</b> Push-in type wire jumper; 1.5 mm <sup>2</sup> ; insulated; 110 mm long; black	<a href="http://www.wago.com/2009-414">www.wago.com/2009-414</a>
	<b>Item no.: 2009-416</b> Push-in type wire jumper; 1.5 mm <sup>2</sup> ; insulated; 250 mm long; black	<a href="http://www.wago.com/2009-416">www.wago.com/2009-416</a>
	<b>Item no.: 2009-414/000-005</b> Push-in type wire jumper; 1.5 mm <sup>2</sup> ; insulated; 110 mm long; black	<a href="http://www.wago.com/2009-414/000-005">www.wago.com/2009-414/000-005</a>
	<b>Item no.: 2009-414/000-006</b> Push-in type wire jumper; insulated; 110 mm long; black	<a href="http://www.wago.com/2009-414/000-006">www.wago.com/2009-414/000-006</a>

## Downloads Documentation

### Bid Text

2003-6641 X81 - Datei	2019 Apr 29	xml 4.3 kB	Download
2003-6641 docx - Datei	2019 Apr 29	docx 15.3 kB	Download

### Additional Information

Technical Section Technical explanations		pdf 2.2 MB	Download
---	--	---------------	----------

## CAD/CAE-Data

### CAD data

2D/3D Models 2003-6641		URL	Download
------------------------	--	-----	----------

### CAE data

EPLAN Data Portal 2003-6641		URL	Download
WSCAD Universe 2003-6641		URL	Download
ZUKEN Portal 2003-6641		URL	Download

Subject to changes. Please also observe the further product documentation!



## Environmental Product Compliance

### Compliance Search

Environmental Product Compliance 2003-6641

[URL](#)

[Download](#)

Multilevel installation terminal block; with operating slots; 2.5 mm<sup>2</sup>; with pivoting knife disconnect; NTi/L/PE; Push-in CAGE CLAMP®; 2,50 mm<sup>2</sup>; gray

---

## Installation Notes

### Conductor termination

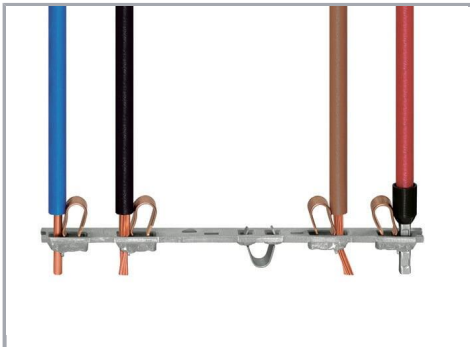

All conductor types at a glance

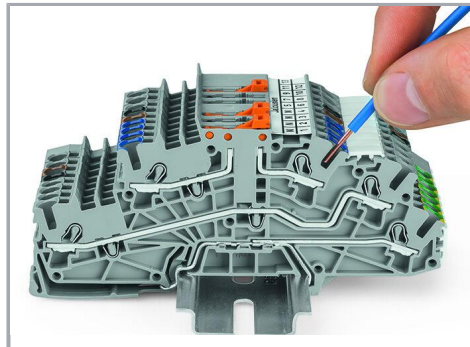

Inserting a conductor via push-in termination.

Solid conductors with cross-sections from either one size above, or up to two sizes below, the rated cross-section can be simply pushed in – no tools needed.

Subject to changes. Please also observe the further product documentation!

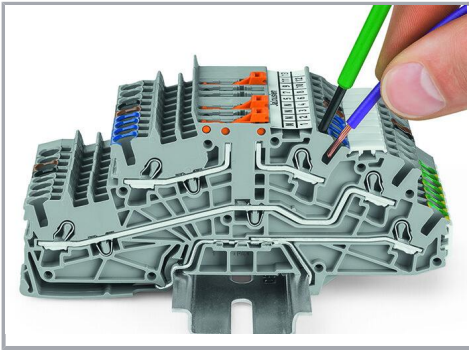

**Inserting a conductor via operating tool.**

Connecting fine-stranded conductors without ferrules, or small cross-sectional conductors that cannot be pushed in, is performed similarly to the original CAGE CLAMP® – just use an operating tool.

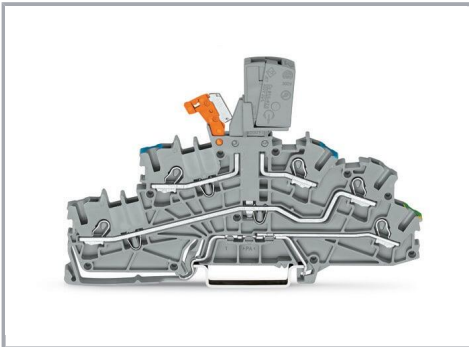

Multilevel installation terminal block (2003-6641) fitted with an N/L-test plug adapter (2003-499) for insulation resistance measurement of the connected N- and L-potentials

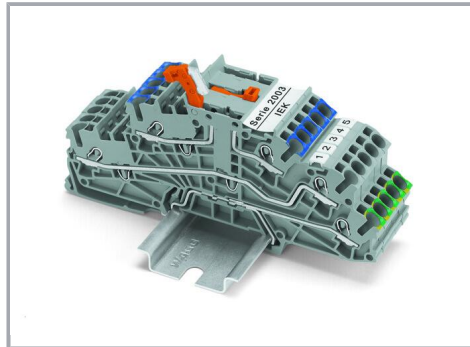

N-potential disconnection via N-knife disconnect within a terminal block assembly without a busbar.

Subject to changes. Please also observe the further product documentation!

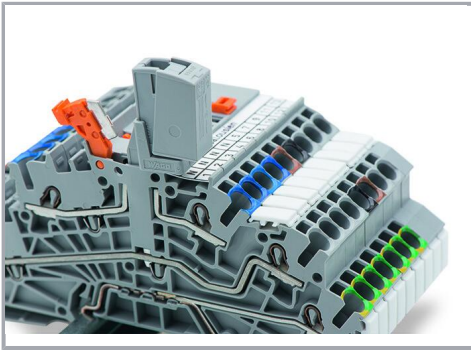

For multilevel installation terminal blocks with internal N-disconnection, test plug adapters can be inserted into the free vertical test slot when the N-potential is disconnected.

### Commoning

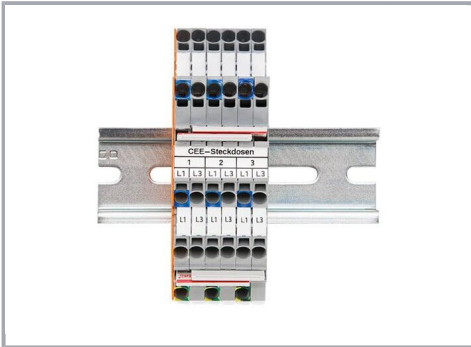

Commoning two potentials in one single jumper slot via extremely slim staggered jumpers.

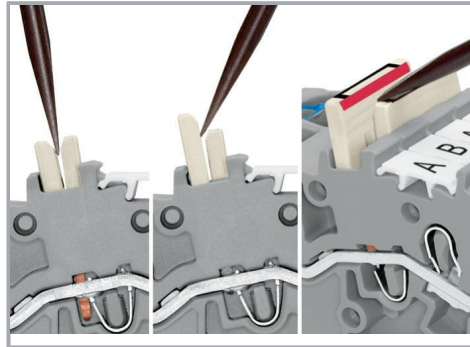

### Removing a staggered jumper:

Insert the operating tool between the staggered jumpers, then lift up the jumper.

### Product family

#### TOPJOB® S

TOPJOB® S: In various industrial applications and modern building installations, WAGO's wide and versatile range of rail-mount terminal blocks provides more than just reliable electrical connections.

[Show all products from the family](#)

Subject to changes. Please also observe the further product documentation!