

NOTES:
 VOLTAGE RATING: 30 V A.C. OR 42 V D.C.
 CURRENT RATING: 0.5 A
 TEMPERATURE RATING:
 STATIC: -40 °C TO 80 °C
 DYNAMIC: -20 °C TO 80 °C
 IP RATING:
 M12 SIDE IP 67 (IN MATED AND LOCKED CONDITION)
 RJ45 SIDE IP 20
 TRANSMISSION CHARACTERISTICS ACCORDING TO ISO/IEC 11801 CLASS E_A CHANNEL
 WITH INSERTION LOSS BEING IGNORED FOR CABLE LENGTHS <1 m OR >65 m
 PACKAGING: CORDSETS ARE PACKED IN A POLYBAG

BILL OF MATERIAL

ITEM	QTY	DESCRIPTION	MATERIAL	FINISH/COLOR
1	1	REC M12 CAT6A	-	-
2	1	PLUG RJ45	-	-
3	1	INSERT M12 XC FE	PA	BLACK
4	8	CONTACT M12 XC FE	BRASS	Au PLATED
5	1	LOCKNUT	BRASS	Ni PLATED
6	1	CABLE 4X2X26/7AWG DIA 6.9	PUR	GREEN
7	1	SHIELD SLEEVE	BRASS	Ni PLATED
8	-	OVERMOLD	TPU	BLACK
9	8	CONTACT RJ45	PB	SELECTIVE Au PLATED
10	1	O-RING	FPM	RED
11	1	O-RING SHELL	EPDM	BLACK
12	2	I/D CARRIER 6-10mmx30mm	PVC	TRANSPARENT
13	1	LABEL 2.0X1.75	VINYL	YELLOW

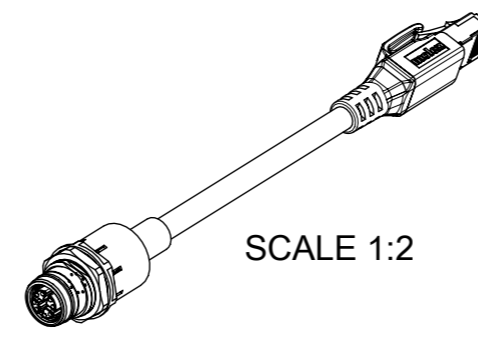

CABLE LENGTH TOLERANCES

LENGTH	TOLERANCE
0m-1m	+40
>1m-5m	+60
>5m-10m	+80
>10m-20m	+140
>20m-30m	+160
>30m	+1% of length

TABLE 1

MOLEX P/N	ENGINEERING NO.	DESCRIPTION	LENGTH [mm]
1203410750	ERWPEU7020M005	REC M12 CAT6A RJ45 FE STR PUR GREEN	500
1203410751	ERWPEU7020M010	REC M12 CAT6A RJ45 FE STR PUR GREEN	1000
1203410752	ERWPEU7020M020	REC M12 CAT6A RJ45 FE STR PUR GREEN	2000
1203410753	ERWPEU7020M030	REC M12 CAT6A RJ45 FE STR PUR GREEN	3000
1203410754	ERWPEU7020M040	REC M12 CAT6A RJ45 FE STR PUR GREEN	4000
1203410755	ERWPEU7020M050	REC M12 CAT6A RJ45 FE STR PUR GREEN	5000
1203410756	ERWPEU7020M100	REC M12 CAT6A RJ45 FE STR PUR GREEN	10000
1203410757	ERWPEU7020M150	REC M12 CAT6A RJ45 FE STR PUR GREEN	15000
WITH ID CARRIER			
1203410915	ERWPEU7020M005H	REC M12 CAT6A RJ45 FE STR PUR GREEN	500
1203410916	ERWPEU7020M010H	REC M12 CAT6A RJ45 FE STR PUR GREEN	1000
1203410917	ERWPEU7020M020H	REC M12 CAT6A RJ45 FE STR PUR GREEN	2000

THIS DRAWING CONTAINS INFORMATION THAT IS PROPRIETARY TO MOLEX ELECTRONIC TECHNOLOGIES, LLC AND SHOULD NOT BE USED WITHOUT WRITTEN PERMISSION

FUNCTIONAL DIMENSION SYMBOLS: $\nabla A = 0$, $\nabla E = 2$, $\nabla F = 0$

SCALE: 2:1

GENERAL TOLERANCES (UNLESS SPECIFIED):

PLACES	MM	INCH
4 PLACES	± 0.3	± 0.012
3 PLACES	± 0.2	± 0.008
2 PLACES	± 0.1	± 0.004
1 PLACE	± 0.05	± 0.002
0 PLACES	± 0.02	± 0.001

ANGULAR TOL: ± 1.0°

DRAFT WHERE APPLICABLE MUST REMAIN WITHIN DIMENSIONS

THIRD ANGLE PROJECTION

DRAWING: A3-SIZE

SERIES: 120341

MATERIAL NUMBER: SEE TABLE 1

CUSTOMER: GENERAL MARKET

SHEET NUMBER: 1 OF 1

EC NO: 692351
 DRWN: ARPITT
 CHK'D: RSILLER
 APPR: RSILLER

INITIAL REVISION:
 DRWN: ZISMAYILOV
 APPR: RSILLER

DATE: 2022/01/19
 DATE: 2022/01/25
 DATE: 2022/01/25

2018/05/06
 2014/05/27

molex

REC M12 CAT6A RJ45 8P FE STR PUR 0.5M

PRODUCT CUSTOMER DRAWING

DOCUMENT NUMBER: 1203410750
 DOC TYPE: PSD
 DOC PART: 000
 REVISION: A11