

High Linearity Mixer

5 - 37 GHz



MAMX-011066

Rev. V2

Features

- Passive Frequency Mixer
- Conversion Loss: 8 dB @ 12 GHz
- High IIP3: 20 dBm @ 12 GHz
- RF Frequency: 5 - 37 GHz
- LO Frequency: 3 - 35 GHz
- IF Frequency: DC - 4.5 GHz
- Lead-Free 1.5 x 1.2 mm TDFN 6-lead Package
- RoHS* Compliant

Applications

- Point-to-Point, Satcom, & LAN

Description

The MAMX-011066 is a passive mixer “engine” assembled in a 1.5 x 1.2 mm TDFN 6-lead plastic package. This device is designed for more linear applications such as high bit rate transmitters and receivers which may be used in Point-to-Point, Satcom or LAN applications. The mixer has 8 dB of conversion loss and 20 dBm of input intercept point (IIP3).

This mixer can be used for either lower sideband (LSB) or upper sideband (USB) mixing. Two of these mixers can be combined in a quadrature configuration for image rejection.

Positive bias voltage (<1 V) can be applied to the LO or the V_G (optional) pin to reduce LO drive requirements. The V_G pin is internally bypassed. Positive bias voltage (<1 V) can also be applied to the IF pin to optimize device linearity.

Ordering Information

Part Number	Package
MAMX-011066	Bulk
MAMX-011066-TR0100	100 Piece Reel ¹
MAMX-011066-TR1000	1000 Piece Reel ¹
MAMX-011066-TR3000	3000 Piece Reel ¹
MAMX-011066-SMB	Sample Board ²

1. Reference Application Note M513 for reel size information.
2. All sample boards include 3 loose parts.

Functional Schematic

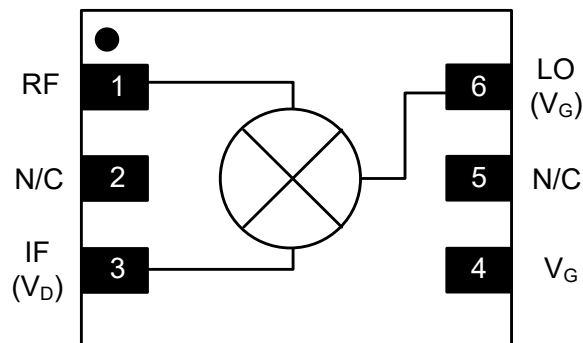

Pin Configuration³

Pin #	Pin Name	Description
1	RF	RF Port
2, 5	N/C	No Connection
3	IF (V_D)	IF Port (optional Drain Voltage)
4	V_G	Gate Voltage (optional)
6	LO (V_G)	LO Port (optional Gate Voltage)
7	Paddle ⁴	Ground

3. MACOM recommends connecting No Connection pins to ground.
4. The exposed pad centered on the package bottom must be connected to RF, DC and thermal ground.

¹ * Restrictions on Hazardous Substances, compliant to current RoHS EU directive.

High Linearity Mixer

5 - 37 GHz



MAMX-011066

Rev. V2

Electrical Specifications: $T_A = +25^\circ\text{C}$, $V_D = \text{open}$, $V_G = \text{open}$, $Z_0 = 50 \Omega$,
IF Freq. = 2 GHz, LO Drive = 14 dBm

Parameter	Test Conditions	Units	Min.	Typ.	Max.
Down Conversion Loss	RF = 5 GHz, IF = 2 GHz RF = 12 GHz, IF = 2 GHz RF = 30 GHz, IF = 2 GHz RF = 37 GHz, IF = 2 GHz	dB	—	9.5 8.0 8.5 9.0	—
Up Conversion Loss	RF = 5 GHz, IF = 2 GHz RF = 12 GHz, IF = 2 GHz RF = 30 GHz, IF = 2 GHz RF = 35 GHz, IF = 2 GHz RF = 37 GHz, IF = 2 GHz	dB	—	9.5 8.0 8.5 8.8 9.0	— — — 11.0 —
RF Return Loss	5 - 37 GHz	dB	—	8	—
LO Return Loss	5 - 37 GHz	dB	—	10	—
IF Return Loss	DC - 4.5 GHz	dB	—	12	—
Input P1dB	—	dBm	—	15	—
Input IP3	$P_{IN} = -15 \text{ dBm}$	dBm	—	20	—

Absolute Maximum Ratings^{5,6}

Parameter	Absolute Maximum
Input Power	22 dBm
Drain Voltage	2 V
Gate Voltage	1 V
Junction Temperature ⁷	+150°C
Operating Temperature	-40°C to +85°C
Storage Temperature	-65°C to +150°C

- Exceeding any one or combination of these limits may cause permanent damage to this device.
- MACOM does not recommend sustained operation near these survivability limits.
- Operating at nominal conditions with $T_J \leq +150^\circ\text{C}$ will ensure $\text{MTTF} > 1 \times 10^6$ hours.

MxN Spurious Rejection @ IF Port (dBc IF)

mRF	nLO				
	0	1	2	3	4
0	xx	-3	30	24	31
1	17	0	27	43	42
2	69	73	48	59	79
3	76	78	81	82	83
4	71	72	81	82	81

Handling Procedures

Please observe the following precautions to avoid damage:

Static Sensitivity

These electronic devices are sensitive to electrostatic discharge (ESD) and can be damaged by static electricity. Proper ESD control techniques should be used when handling these Class 1A (HBM) devices.

Application Information

The MAMX-011066 is designed to be an economical and easily used mixer. The ultra small size and passive structure allows easy placement on any system board.

Optional DC Biasing

As shown in the Application Schematic, the MAMX-011066 does not require DC biasing. The V_G pin should be left open if not used for biasing.

Optionally, applying up to 0.5 V bias through the V_G pin (or through the LO pin) can reduce the mixer LO drive requirement (in general, reducing LO drive will reduce input IP3). Any DC voltage applied through the V_G pin will appear on the LO pin, so when biasing V_G it may be necessary to have a DC blocking capacitor on the LO pin. See the Optional DC Biasing Schematic.

Input IP3 may be increased by applying small amounts of voltage ($V_D < 1$ V) to the IF pin. The IF pin will draw a small current (typically < 20 mA) when V_D is positive so bias through an inductor or resistor (accounting for the voltage drop). The inductor or the resistor should have an impedance large compared to 50Ω at the IF frequency (typically at least 200Ω).

Grounding

It is recommended that the total ground (common mode) inductance not exceed 0.03 nH. This is equivalent to three 8-mil ($200 \mu\text{m}$) diameter vias under the device on an 8-mil thick PC board combined with vias included in the ground plane around the package.

Recommended PCB Layout

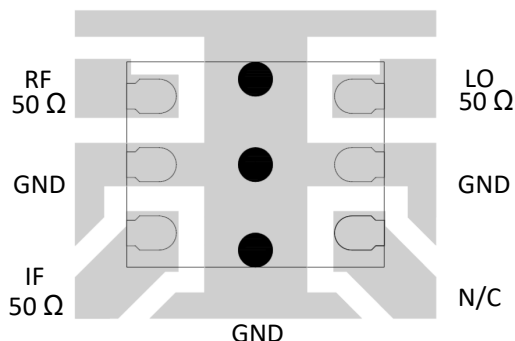

Application Schematic

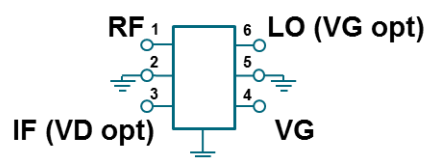

Optional DC Biasing Schematic

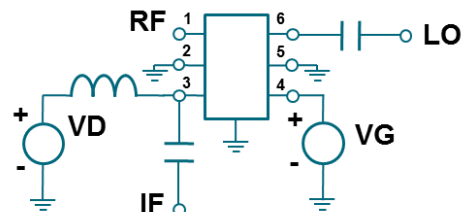

High Linearity Mixer

5 - 37 GHz



MAMX-011066

Rev. V2

Typical Performance Curves:

RF = -20 dBm, LO = 14 dBm, IF = 2 GHz, V_G = open, Z_O = 50 Ω , (unless otherwise noted)

Conversion Gain (down)

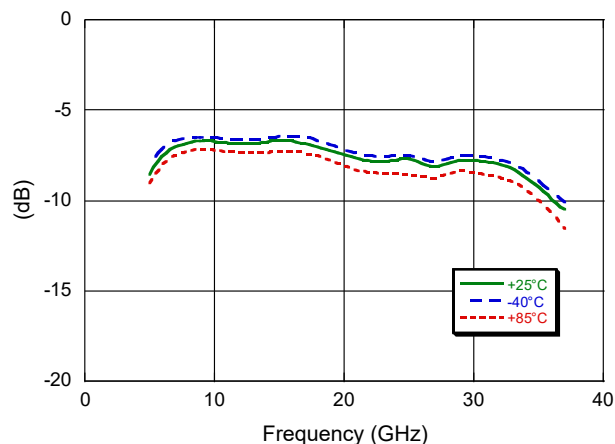

Conversion Gain (up)

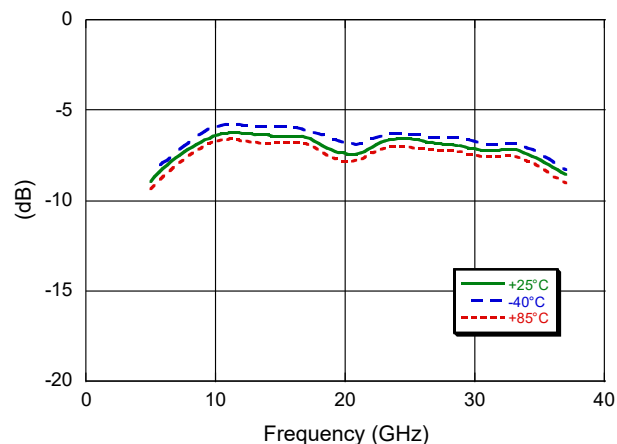

Isolation

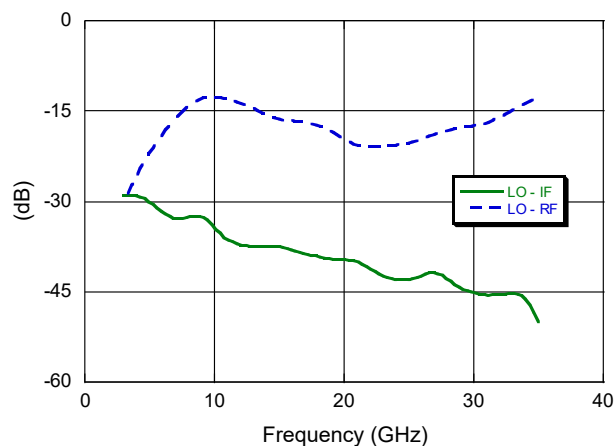

Gain vs. IF Frequency

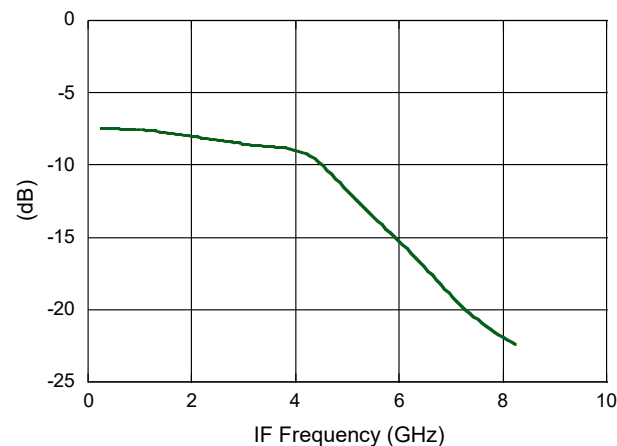

High Linearity Mixer 5 - 37 GHz



MAMX-011066

Rev. V2

Typical Performance Curves:

RF = -20 dBm, LO = 14 dBm, IF = 2 GHz, V_G = open, Z_O = 50 Ω , (unless otherwise noted)

Input IP3 (Up Conversion)

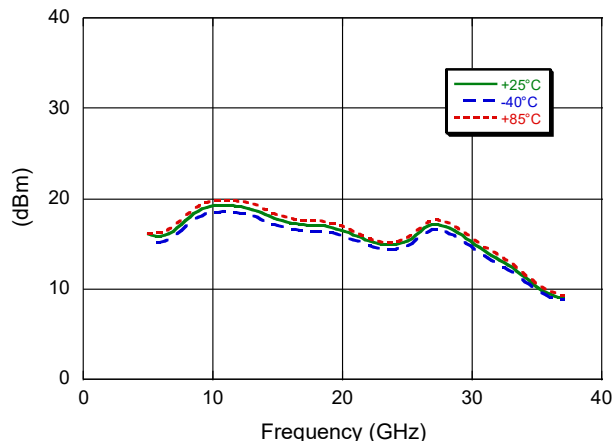

Input P1dB (Up Conversion)

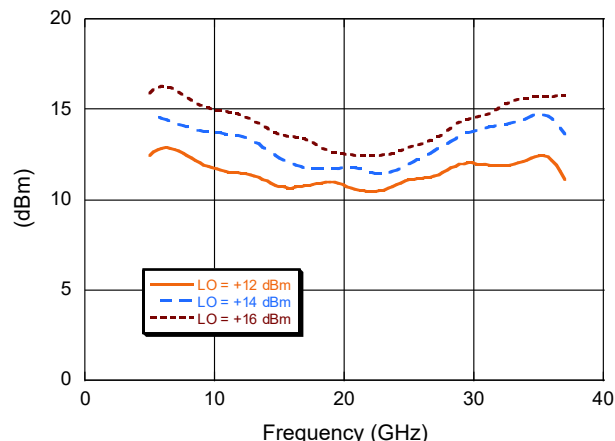

Input IP3 (Down Conversion)

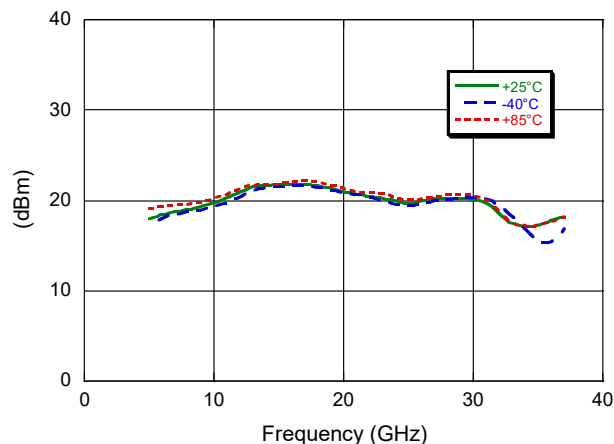

Input P1dB (Down Conversion)

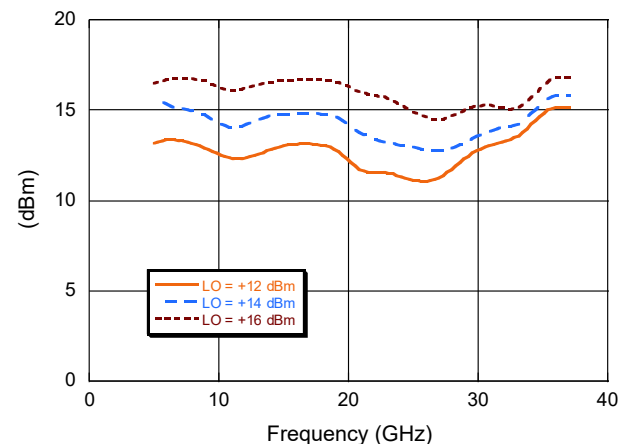

High Linearity Mixer

5 - 37 GHz



MAMX-011066

Rev. V2

Typical Performance Curves: Down Conversion,
 $T_A = +25^\circ\text{C}$, $RF = -20\text{ dBm}$, $LO = 14\text{ dBm}$, $IF = 2\text{ GHz}$, $V_G = \text{open}$, $Z_O = 50\ \Omega$, (unless otherwise noted)

RF Port Return Loss vs. Frequency

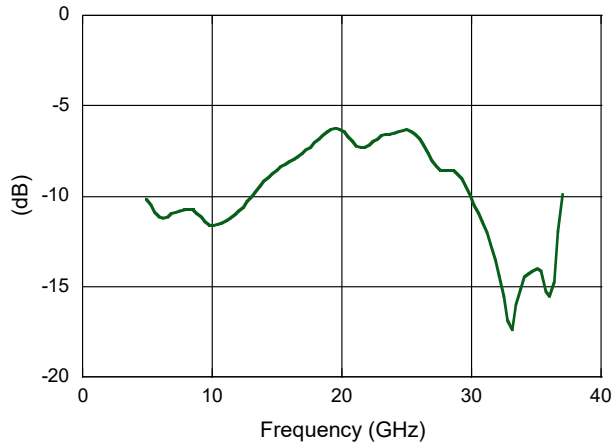

LO Port Return Loss vs. Frequency

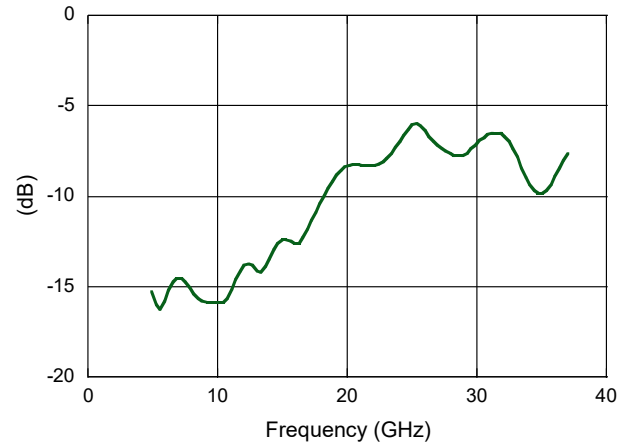

IF Port Return Loss vs. Frequency

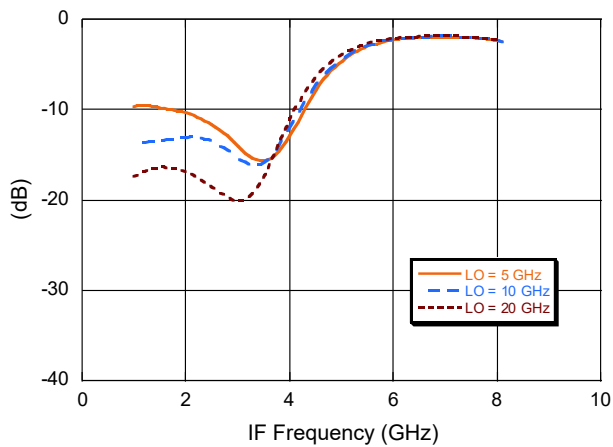

IP2

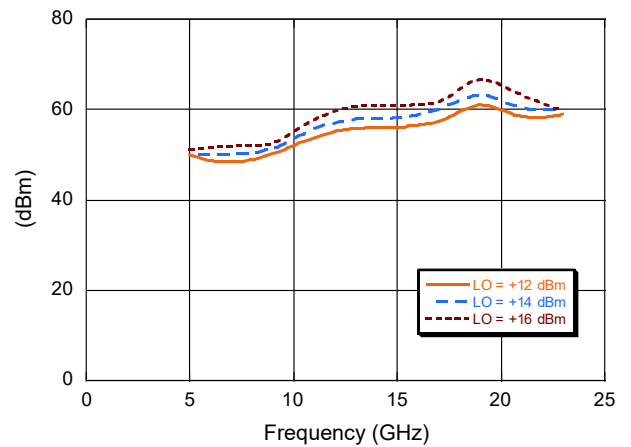

High Linearity Mixer

5 - 37 GHz



MAMX-011066

Rev. V2

Lead-Free 1.5 x 1.2 mm 6-Lead TDFN[†]

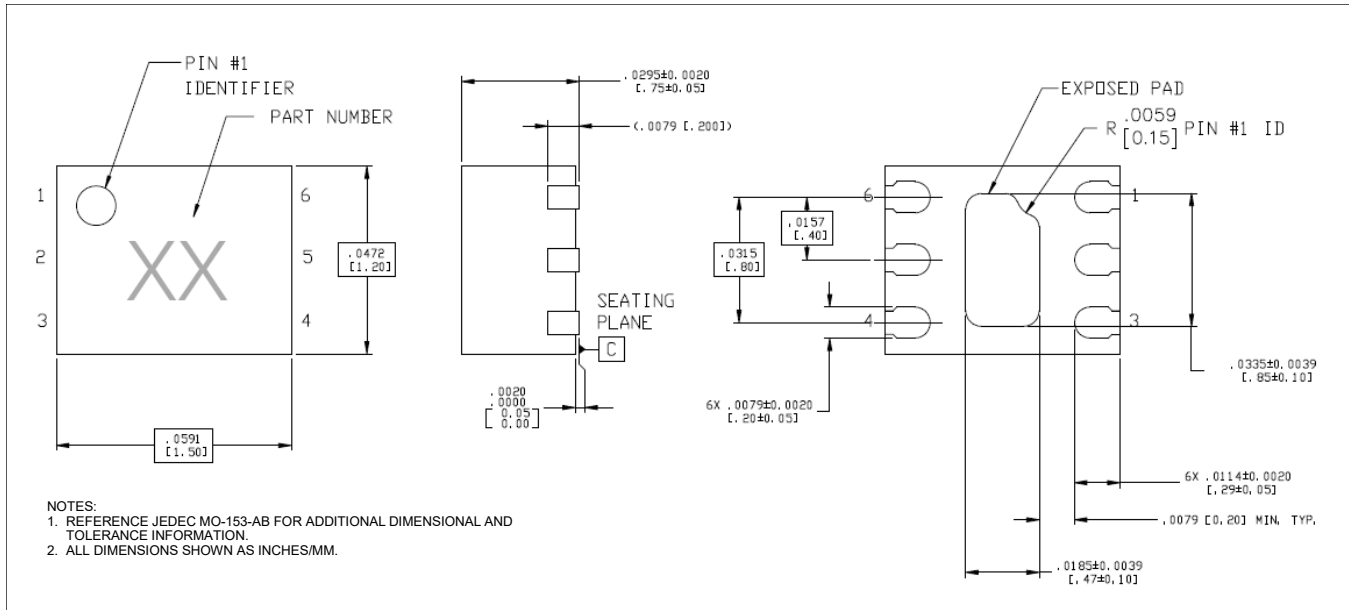

[†] Reference Application Note S2083 for lead-free solder reflow recommendations.
 Meets JEDEC moisture sensitivity level (MSL) 1 requirements.
 Plating is 100% matte tin over copper.

Applications Section

System usage of this Mixer

The MAMX-011066 may be used in single ended, balanced, and image reject circuit configurations.

Single Ended Mixer

Internally the MAMX-011066 is a single ended mixer. One disadvantage of a single ended mixer is the minimal LO rejection at the IF and RF ports. Multiple MAMX-011066 mixers can be combined with baluns or 90° hybrids to produce balanced mixers or image reject mixers. Generally these configurations will have an improved IP3 and greater rejection of unwanted frequencies.

Balanced Mixer

The balanced mixer will improve mixer performance by cancelling the LO at the IF output and cancelling RF second order products. Linearity will be improved by using two mixers and RF loss will be limited to the 180° hybrid and transformer insertion losses. LO drive requirements will be increased 3dB by the need to drive a second mixer. Also, the 0° hybrid losses must be added to the LO drive. A LO buffer such as a MACOM's MAAM-011100 or MAAM-011109 may be used to allow a lower power LO source.

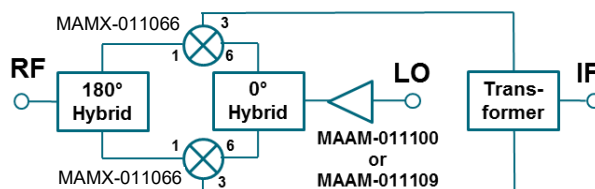
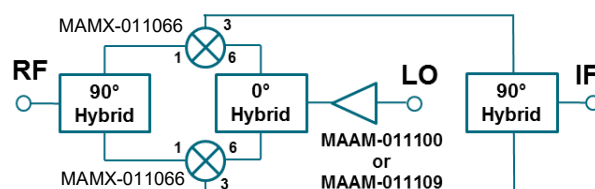

Image Reject Mixer

An image reject mixer can be constructed from two MAMX-011066 mixers, a 0° hybrid and two 90° hybrids. The connection of the IF 90° hybrid ports determines if the upper or lower sideband RF signal is passed to the IF and the corresponding image is rejected. Similar to the balanced mixer a 3 dB LO power increase is required because of the second mixer. Buffer amplifiers such as a MACOM MAAM-011100 or MAAM-011109 may be used to provide the additional power.



MACOM Technology Solutions Inc. ("MACOM"). All rights reserved.

These materials are provided in connection with MACOM's products as a service to its customers and may be used for informational purposes only. Except as provided in its Terms and Conditions of Sale or any separate agreement, MACOM assumes no liability or responsibility whatsoever, including for (i) errors or omissions in these materials; (ii) failure to update these materials; or (iii) conflicts or incompatibilities arising from future changes to specifications and product descriptions, which MACOM may make at any time, without notice. These materials grant no license, express or implied, to any intellectual property rights.

THESE MATERIALS ARE PROVIDED "AS IS" WITH NO WARRANTY OR LIABILITY, EXPRESS OR IMPLIED, RELATING TO SALE AND/OR USE OF MACOM PRODUCTS INCLUDING FITNESS FOR A PARTICULAR PURPOSE, MERCHANTABILITY, INFRINGEMENT OF INTELLECTUAL PROPERTY RIGHT, ACCURACY OR COMPLETENESS, OR SPECIAL, INDIRECT, INCIDENTAL, OR CONSEQUENTIAL DAMAGES WHICH MAY RESULT FROM USE OF THESE MATERIALS.

MACOM products are not intended for use in medical, lifesaving or life sustaining applications. MACOM customers using or selling MACOM products for use in such applications do so at their own risk and agree to fully indemnify MACOM for any damages resulting from such improper use or sale.