

SCALA NON IMPEGNATIVA
(DO NOT SCALE)
DIMENSIONI IN mm
(DIMENSIONS IN mm)

METRIC

PROIEZIONE EUROPEA
(EUROPEAN PROJECTION)

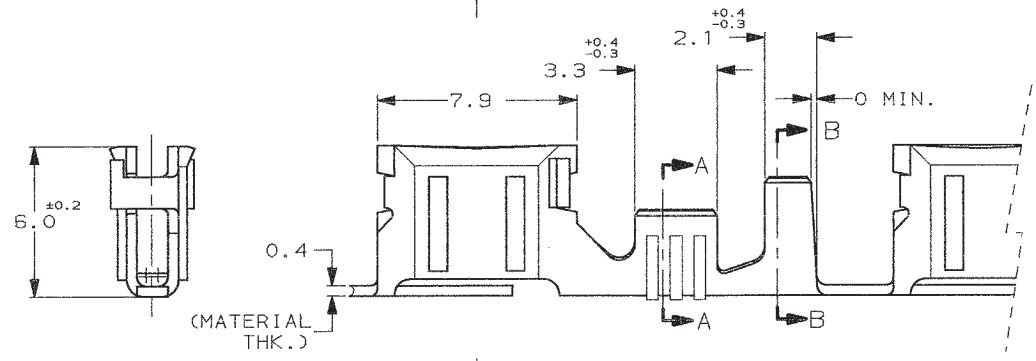
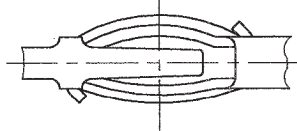
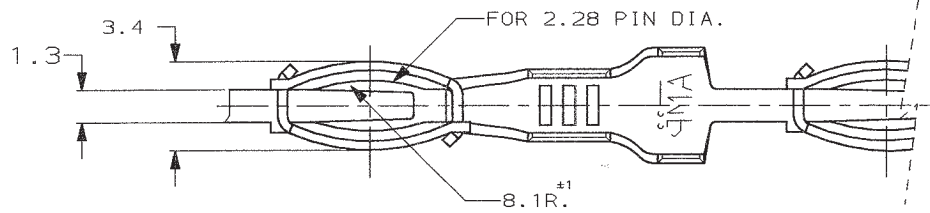

SEZIONE A-A
(SECTION A-A)

SEZIONE B-B
(SECTION B-B)

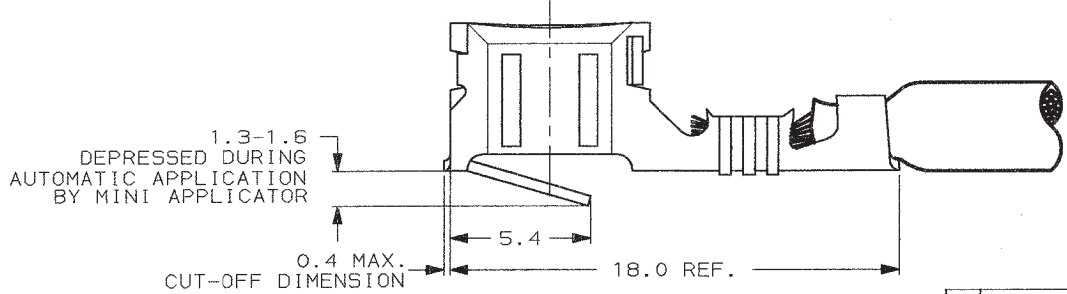
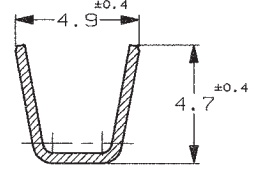
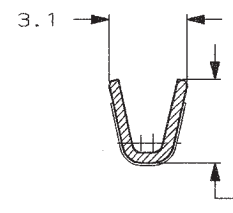

1) STATO DI FORNITURA -SCALA 1:1-
(SUPPLY CONDITION -SCALE 1:1-)

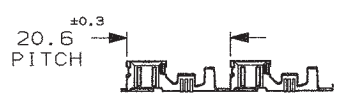

SENSO DI USCITA
DEL TERMINALE
DALLA BOBINA
(DIRECTION OFF
TOP OF REEL)

2) CONFEZIONATO IN ACCORDO ALLA AMP SPEC. 107-20211.
(PACKAGING ACCORDING TO AMP SPEC. 107-20211).

3) REELED WITH INTERLEAVE PAPER.

STAGNATO (TIN PLATED)	BRONZO FOSF. (PH. BRONZE)	0-160640-2	Z
NUDO (UNPLATED)	BRONZO FOSF. (PH. BRONZE)	0-160640-1	Z
FINITURA / COLORE (FINISH / COLOUR)	MATERIALE (MATERIAL)	NUMERO (AMP P/N)	REV

CUSTOMER DWG. FOR REFERENCE ONLY DISEGNO PER CLIENTE SOLO PER RIFERIMENTO

THIS DRAWING IS UNPUBLISHED. RELEASE FOR PUBLICATION 19
© COPYRIGHT 19 BY AMP INCORPORATED, HARRISBURG, PA. ALL INTERNATIONAL RIGHT RESERVED. AMP PRODUCTS MAY BE COVERED BY U.S. AND FOREIGN PATENT AND/OR PATENT PENDING

TOLLERANZE, SE NON DIVERSAMENTE SPECIFICATO (TOLERANCES, UNLESS OTHERWISE SPECIFIED)	DIAM. ISOLANTE (INS. DIA. RANGE) mm	RANGO FILO (WIRE RANGE) (O.B. = 1.5 mm ²)	SCALA (SCALE)
± 0.3	3.4-4.1	18-16 AWG	5:1



ANGOLI (ANGLES) ± 2°
DIS. H. YAALI (COR.) 11 JAN 2000

DESCRIZIONE (DESCRIPTION)
SNAP-IN CLUSTER REC. CONTACT

Z1	REVISED PER ECR-19-015041	PC	07NOV	CONT. C. TARTARI
Z	REVISED & REDRAWN ETOQ-0407-99	MB	13JAN	11 JAN 2000
REV.	REVISIONI (REVISION RECORD)	H. Y	2000	APP. (APP.)
DIS. (DR)		DIS. (DR)	DATA (DATE)	
LOC. (LOC)	IA3	NUMERO (DWG NO)	C-160640	REV. (REV.)
				FGLIO (SHEET) 1 DI 1

DISTRIBUZIONE (PRINT-DIST.)