

THIS DOCUMENT IS SUBJECT TO CHANGE WITHOUT NOTICE. IT IS CONFIDENTIAL AND A PROPERTY OF Amphenol LTW. DISCLOSURE TO THIRD PARTY HAS TO BE AUTHORIZED BY Amphenol LTW.

REV.	ECN NO.	DATE	SIGN	DESCRIPTION

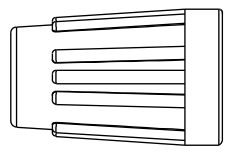

7 Sealing Nut

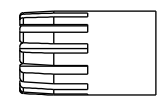

6 Clamp Ring

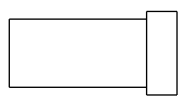

5 Seals B2

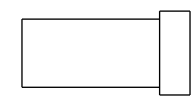

4 Seals B1

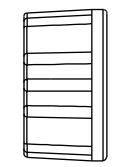

3 Nut

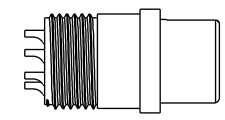

2 Connector



1 O-Ring

ALTW  
DCC. DEPT.  
CONFIDENTIAL  
2012-04-05  
ISSUED

ALTW  
CONFIDENTIAL  
2012-03-26  
R&D DEPT.

Note:

- \* Seals B1 for Cable OD:  $\varnothing 4.5\text{mm} \sim \varnothing 6.5\text{mm}$   
(防水墊圈B1線徑:  $\varnothing 4.5\text{mm} \sim \varnothing 6.5\text{mm}$ )
- \* Seals B2 for Cable OD:  $\varnothing 3.5\text{mm} \sim \varnothing 5.3\text{mm}$   
(防水墊圈B2線徑:  $\varnothing 3.5\text{mm} \sim \varnothing 5.3\text{mm}$ )
- \* One Set Unassembled in One PE Bag  
(每一組未組裝, 放置於一個PE袋, 並封口)
- \*  $\text{CC}$  Important Dimension.
- \* Waterproof Rate : IP66
- \* Ring: Black, EPDM
- \* Housing: Black, Nylon+GF
- \* Pin: Copper Alloy, Gold Plated
- \* Screw Nut: Black, Nylon+GF
- \* Seals: Black, EPDM
- \* Clamping Ring: Black, Nylon
- \* Sealing Nut: Black, Nylon
- \* PE Bag: 90mm\*85mm

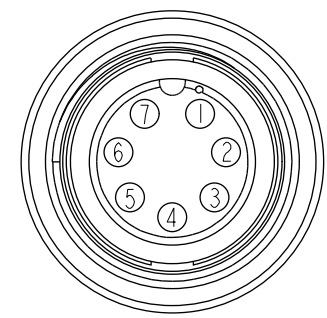
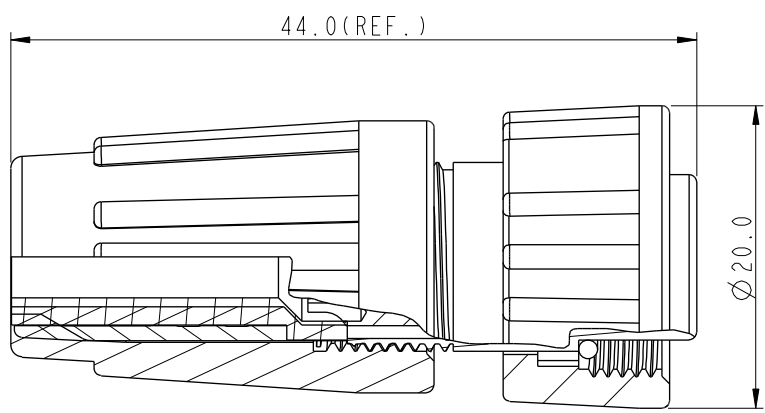

Pin Assignments  
Front View 前視圖

UNIT: mm		
TOLERANCE	.X $\pm 0.25$	
	.XX $\pm 0.1$	
	.XXX $\pm 0.05$	
ANGLES	$\pm 1^\circ$	

TITLE Standard, Assy Screw 7Pin F Conn F Pin			
SCALE 1:1	SIZE A4	SHEET 1 OF 1	
REV. A	WC-REV. A.2	$\text{CC}$ : Inspection item	

**Amphenol LTW**  
安費諾亮泰企業股份有限公司

ITEM NO. BD-07BFFA-SL6001	DRAWN BY SamChang	DATE 2012-03-26
DWG NO. BD-07BFFA-SL6001	CHECKED BY Jeffrey	DATE 2012-04-05
CUSTOMER ALTW	APPROVED BY Lion	DATE 2012-04-05