



WSE16P-34162100A00

W16

SMALL PHOTOELECTRIC SENSORS

SICK
Sensor Intelligence.



Ordering information

Type	Part no.
WSE16P-34162100A00	1088330

Other models and accessories → www.sick.com/W16

Illustration may differ



Detailed technical data

Features

Sensor/ detection principle	Through-beam photoelectric sensor
Dimensions (W x H x D)	20 mm x 55.7 mm x 42 mm
Housing design (light emission)	Rectangular
Sensing range max.	0 m ... 45 m
Type of light	Visible red light
Light source	PinPoint LED ¹⁾
Light spot size (distance)	Ø 90 mm (8 m)
Wave length	635 nm
Adjustment	
	IO-Link For configuring the sensor parameters and Smart Task functions
	Wire/pin For activating the test input
Indication	
	LED indicator blue BluePilot: Alignment aid
	LED indicator green Operating indicator Static: power on Flashing: IO-Link mode
	LED indicator yellow Status of received light beam Static: object not present Static off: object present Flashing: Below the 1.5 function reserve

¹⁾ Average service life: 100,000 h at T_U = +25 °C.

Pin 2 configuration	External input, Teach-in, switching signal
----------------------------	--

¹⁾ Average service life: 100,000 h at $T_U = +25 \text{ °C}$.

Mechanics/electronics

Supply voltage	10 V DC ... 30 V DC ¹⁾
Ripple	$< 5 V_{pp}$
Power consumption, sender	$\leq 30 \text{ mA}$ ²⁾ $< 50 \text{ mA}$ ³⁾
Power consumption, receiver	$\leq 30 \text{ mA}$ ²⁾ $< 50 \text{ mA}$ ³⁾
Switching output	Push-pull: PNP/NPN
Output: Q_{L1} / C	Switching output or IO-Link mode
Output function	Factory setting: Pin 2 / white (MF): NPN normally closed (light switching), PNP normally open (dark switching), Pin 4 / black (QL1 / C): NPN normally open (dark switching), PNP normally closed (light switching), IO-Link
Switching mode	Light/dark switching
Signal voltage PNP HIGH/LOW	Approx. $V_S - 2.5 \text{ V} / 0 \text{ V}$
Signal voltage NPN HIGH/LOW	Approx. $V_S / < 2.5 \text{ V}$
Output current I_{max}	$\leq 100 \text{ mA}$
Response time	$\leq 500 \mu\text{s}$ ⁴⁾
Switching frequency	1,000 Hz ⁵⁾
Connection type	Cable with M12 male connector, 4-pin, 270 mm ⁶⁾
Cable material	PVC
Circuit protection	A ⁷⁾ B ⁸⁾ C ⁹⁾ D ¹⁰⁾
Protection class	III
Weight	140 g
Housing material	Plastic, VISTAL®
Optics material	Plastic, PMMA
Enclosure rating	IP66 (According to EN 60529) IP67 (According to EN 60529) IP69 (According to EN 60529) ¹¹⁾
Test input sender off	Test at 0 V

¹⁾ Limit values.

²⁾ 16 V DC ... 30 V DC, without load.

³⁾ 10 V DC ... 16 V DC, without load.

⁴⁾ Signal transit time with resistive load in switching mode. Different values possible in COM2 mode.

⁵⁾ With light/dark ratio 1:1 in switching mode. Different values possible in IO-Link mode.

⁶⁾ Do not bend below 0 °C.

⁷⁾ A = V_S connections reverse-polarity protected.

⁸⁾ B = inputs and output reverse-polarity protected.

⁹⁾ C = interference suppression.

¹⁰⁾ D = outputs overcurrent and short-circuit protected.

¹¹⁾ Replaces IP69K with ISO 20653: 2013-03.

Ambient operating temperature	-40 °C ... +60 °C
Ambient temperature, storage	-40 °C ... +75 °C
UL File No.	NRKH.E181493 & NRKH7.E181493

- 1) Limit values.
- 2) 16 V DC ... 30 V DC, without load.
- 3) 10 V DC ... 16 V DC, without load.
- 4) Signal transit time with resistive load in switching mode. Different values possible in COM2 mode.
- 5) With light/dark ratio 1:1 in switching mode. Different values possible in IO-Link mode.
- 6) Do not bend below 0 °C.
- 7) A = V_S connections reverse-polarity protected.
- 8) B = inputs and output reverse-polarity protected.
- 9) C = interference suppression.
- 10) D = outputs overcurrent and short-circuit protected.
- 11) Replaces IP69K with ISO 20653: 2013-03.

Safety-related parameters

MTTF_D	539 years
DC_{avg}	0%

Communication interface

Communication interface	IO-Link V1.1
Communication Interface detail	COM2 (38,4 kBaud)
Cycle time	2.3 ms
Process data length	16 Bit
Process data structure	Bit 0 = switching signal Q _{L1} Bit 1 = switching signal Q _{L2} Bit 2 ... 15 = empty
VendorID	26
DeviceID HEX	0x800174
DeviceID DEC	8388980

Smart Task

Smart Task name	Base logics
Logic function	Direct AND OR Window Hysteresis
Timer function	Deactivated On delay Off delay ON and OFF delay Impulse (one shot)
Inverter	Yes
Switching frequency	SIO Direct: 1000 Hz ¹⁾ SIO Logic: 800 Hz ²⁾ IOL: 650 Hz ³⁾
Response time	SIO Direct: 500 μs ¹⁾

¹⁾ SIO Direct: sensor operation in standard I/O mode without IO-Link communication and without using internal sensor logic or time parameters (set to "direct"/"deactivated").

²⁾ SIO Logic: Sensor operation in standard I/O mode without IO-Link communication. Sensor-internal logic or timing parameters plus Automation Functions used.

³⁾ IOL: Sensor operation with full IO-Link communication and usage of logic, timing and Automation Function parameters.

	SIO Logic: 600 μs ²⁾ IOL: 750 μs ³⁾
Repeatability	SIO Direct: 150 μs ¹⁾ SIO Logic: 300 μs ²⁾ IOL: 400 μs ³⁾
Switching signal Q_{L1}	Switching output
Switching signal Q_{L2}	Switching output

1) SIO Direct: sensor operation in standard I/O mode without IO-Link communication and without using internal sensor logic or time parameters (set to "direct"/"deactivated").

2) SIO Logic: Sensor operation in standard I/O mode without IO-Link communication. Sensor-internal logic or timing parameters plus Automation Functions used.

3) IOL: Sensor operation with full IO-Link communication and usage of logic, timing and Automation Function parameters.

Classifications

ECl@ss 5.0	27270901
ECl@ss 5.1.4	27270901
ECl@ss 6.0	27270901
ECl@ss 6.2	27270901
ECl@ss 7.0	27270901
ECl@ss 8.0	27270901
ECl@ss 8.1	27270901
ECl@ss 9.0	27270901
ECl@ss 10.0	27270901
ECl@ss 11.0	27270901
ETIM 5.0	EC002716
ETIM 6.0	EC002716
ETIM 7.0	EC002716
UNSPSC 16.0901	39121528

Connection diagram

Cd-392

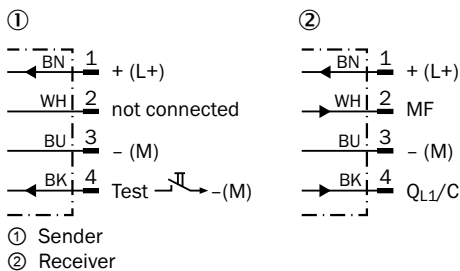

Characteristic curve

WSE16P-xxxxx1xx, WSE16I-xxxxx1xx

Function reserve

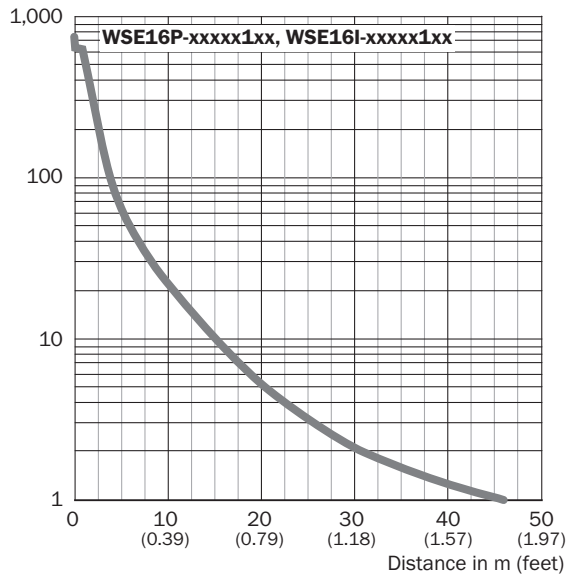

Light spot size

Visible red light

Radius in mm (inch)

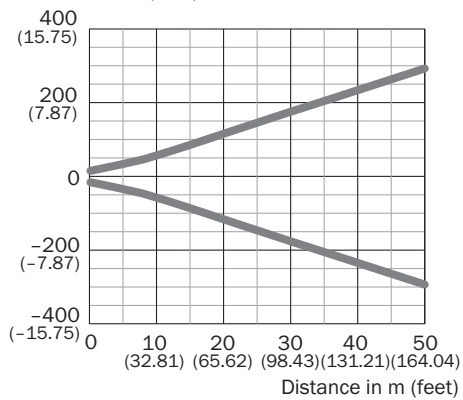

WSE16P-xxxxx1xx

Sensing range diagram

WSE16P-xxxxx1xx, WSE16I-xxxxx1xx

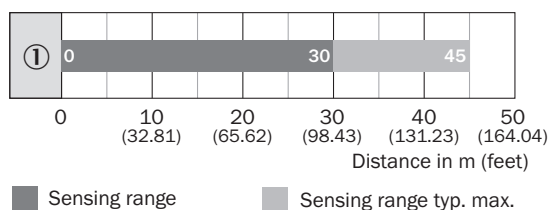

Functions

Operation note

BluePilot: Blue indicator LEDs with double benefits

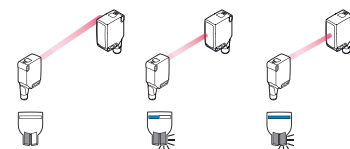
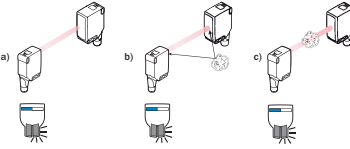
<p>Easy and quick sensor alignment with the help of the LED indicator</p> <p>All blue LEDs illuminate</p> <ul style="list-style-type: none"> - optimum alignment - highest possible operating reserve 	<p>WSE through-beam photoelectric sensor alignment</p> 
<p>Service note</p> <p>A reduction in sensor availability is displayed by a decrease of the blue LEDs.</p> <p>Possible causes:</p> <ol style="list-style-type: none"> insufficient alignment contamination of the optical surfaces particles in the light beam 	

Operation note

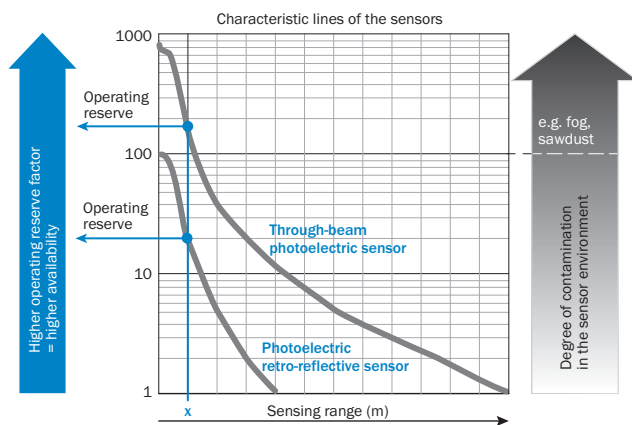

At a sensing range of „x“ the photoelectric retro-reflective and through-beam photoelectric sensors have different operating reserves (see blue arrow). The higher the operating reserve factor, the better the sensor can compensate the contamination in the air or in the light beam and on the optical surfaces (front screen, reflector), i.e. the sensor has the maximum availability, otherwise the sensor switches due to pollution although there is no object in the path of the light beam.

Adjustments

Display and adjustment elements

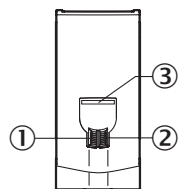

- ① LED indicator green
- ② LED indicator yellow
- ③ LED indicator blue

Dimensional drawing (Dimensions in mm (inch))



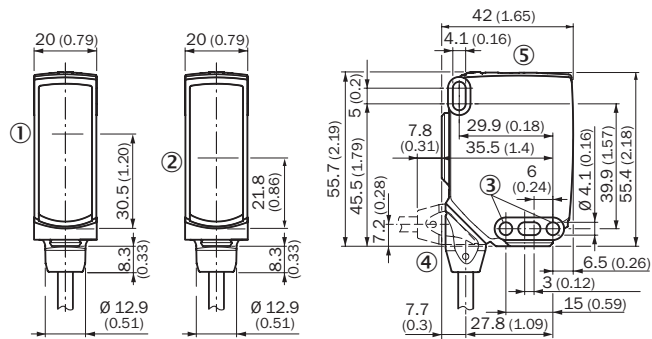

WSE16, cable



- ① Center of optical axis, sender
- ② Center of optical axis, receiver
- ③ Mounting hole, \varnothing 4.1 mm
- ④ Connection
- ⑤ Display and adjustment elements

Recommended accessories

Other models and accessories → www.sick.com/W16

	Brief description	Type	Part no.
Universal bar clamp systems			
	Plate NO2 for universal clamp bracket, Zinc plated steel (sheet), Zinc die cast (clamping bracket), Universal clamp (5322626), mounting hardware	BEF-KHS-N02	2051608
Mounting brackets and plates			
	Adapter for mounting W16 sensors in existing W14-2/W18-3 installations or L25 sensors in existing L28 installations, plastic, fastening screws included	BEF-AP-W16	2095677
Plug connectors and cables			
	Head A: female connector, M12, 4-pin, straight, A-coded Head B: Flying leads Cable: Sensor/actuator cable, PVC, unshielded, 5 m	YF2A14-050VB3XLEAX	2096235
	Head A: male connector, M12, 4-pin, straight Head B: - Cable: unshielded	STE-1204-G	6009932

Recommended services

Additional services → www.sick.com/W16

	Type	Part no.
Function Block Factory		
<ul style="list-style-type: none">Description: The Function Block Factory supports common programmable logic controllers (PLCs) from various manufacturers, such as Siemens, Beckhoff, Rockwell Automation and B&R. More information on the FBF can be found <a _blank"="" href="https://fbf.cloud.sick.com target=">here.	Function Block Factory	On request

SICK AT A GLANCE

SICK is one of the leading manufacturers of intelligent sensors and sensor solutions for industrial applications. A unique range of products and services creates the perfect basis for controlling processes securely and efficiently, protecting individuals from accidents and preventing damage to the environment.

We have extensive experience in a wide range of industries and understand their processes and requirements. With intelligent sensors, we can deliver exactly what our customers need. In application centers in Europe, Asia and North America, system solutions are tested and optimized in accordance with customer specifications. All this makes us a reliable supplier and development partner.

Comprehensive services complete our offering: SICK LifeTime Services provide support throughout the machine life cycle and ensure safety and productivity.

For us, that is “Sensor Intelligence.”

WORLDWIDE PRESENCE:

Contacts and other locations –www.sick.com