

# LUXEON HL2Z

## High Flux Density in a Proven Package for Precise Optical Control

LUXEON HL2Z is a 2mm square CSP-based, high power, un-domed emitter designed to provide leading flux density, superior color consistency, high luminance, and extreme flexibility in lighting solutions.

LUXEON HL2Z emitters are an ideal choice for fast time-to-market due to their ease of design-in, and their ability to lower system costs through improved performance while delivering the quality of light that is desired by lighting system designers and users.



### FEATURES AND BENEFITS

Undomed source makes it easier to increase optical efficiency and to realize narrow beam angles.

CSP die technology enables close packing of the LEDs, high efficacy, and high drive current capability, in unique applications

Reliable and proven color consistency support high quality illumination, inside and outside

DLC R9 enabled to offer best-in-class color quality for luminaires

### PRIMARY APPLICATIONS

High Bay

Low Bay

Torch

Head Lamps

Wall Grazer

Wall Wash

[More...](#)

# Table of Contents

<b>General Product Information</b> .....	<b>2</b>
Product Test Conditions .....	2
Part Number Nomenclature .....	2
Lumen Maintenance .....	2
Environmental Compliance .....	2
<b>Performance Characteristics</b> .....	<b>3</b>
Product Selection Guide .....	3
Optical Characteristics .....	3
Electrical and Thermal Characteristics .....	4
<b>Absolute Maximum Ratings</b> .....	<b>4</b>
<b>Characteristic Curves</b> .....	<b>5</b>
Spectral Power Distribution Characteristics .....	5
Light Output Characteristics .....	6
Forward Current Characteristics .....	9
Radiation Pattern Characteristics .....	11
<b>Product Bin and Labeling Definitions</b> .....	<b>12</b>
Decoding Product Bin Labeling .....	12
<b>Luminous Flux Bins</b> .....	<b>13</b>
Color Bin Definitions .....	14
Forward Voltage Bins .....	15
<b>Mechanical Dimensions</b> .....	<b>15</b>
<b>Reflow Soldering Guidelines</b> .....	<b>16</b>
JEDEC Moisture Sensitivity .....	16
Solder Pad Design .....	17
<b>Packaging Information</b> .....	<b>18</b>
Pocket Tape Dimensions .....	18
Reel Dimensions .....	18

# General Product Information

## Product Test Conditions

LUXEON HL2Z LEDs are tested and binned with a DC drive current of 700mA, at a junction temperature,  $T_j$ , of 85°C.

## Part Number Nomenclature

Part numbers for LUXEON HL2Z follow the convention below:

L 1 H Z – **x x** **y y** 2 z z z z z z z z

Where:

- x x** – any alphanumeric character that designates nominal ANSI CCT (for example, 27=2700K, 30=3000K, 35=3500K, 40=4000K, 50=5000K, 57=5700K, 65=6500K)
- y y** – any alphanumeric character that designates minimum CRI (for example, 70=70CRI, 80=80CRI, 90=90CRI)
- z** – any alphanumeric character that designates performance options (for example, 0=standard)
- zzzz zzzz – designates option codes for custom/bins/etc.

Therefore, the following part number is used for a LUXEON HL2Z 3000K 70CRI LED:

L 1 H Z – **3 0 7 0** 2 0 0 0 0 0 0 0 0

Note: All LUXEON HL2Z Parts are binned for meeting R9 specifications unless otherwise specified.

## Lumen Maintenance

Please contact your local Sales Representative or Lumileds Technical Solutions Manager for more information about the long-term performance of this product.

## Environmental Compliance

Lumileds LLC is committed to providing environmentally friendly products to the solid-state lighting market. LUXEON HL2Z is compliant to the European Union directives on the restriction of hazardous substances in electronic equipment, namely the RoHS Directive 2011/65/EU and REACH Regulation (EC) 1907/2006. Lumileds LLC will not intentionally add the following restricted materials to its products: lead, mercury, cadmium, hexavalent chromium, polybrominated biphenyls (PBB) or polybrominated diphenyl ethers (PBDE).

# Performance Characteristics

## Product Selection Guide

Table 1. Product performance of LUXEON HL2Z at 700mA, T<sub>j</sub>=85°C.

NOMINAL CCT	MINIMUM R9 <sup>[3]</sup>	MINIMUM CRI <sup>[1]</sup>	LUMINOUS FLUX <sup>[2]</sup> (lm)		TYPICAL LUMINOUS EFFICACY (lm/W)	PART NUMBER
			MINIMUM	TYPICAL		
			700mA			
3000K	-40	70	270	296	149	L1HZ-3070200000000
4000K	-40	70	290	315	159	L1HZ-4070200000000
5000K	-40	70	290	314	159	L1HZ-5070200000000
5700K	-40	70	290	314	159	L1HZ-5770200000000
6500K	-40	70	290	312	157	L1HZ-6570200000000
2200K	0	80	210	225	114	L1HZ-2280200000000
2700K	0	80	230	257	130	L1HZ-2780200000000
3000K	0	80	240	265	134	L1HZ-3080200000000
3500K	0	80	250	280	141	L1HZ-3580200000000
4000K	0	80	260	286	144	L1HZ-4080200000000
5000K	0	80	260	288	145	L1HZ-5080200000000
2700K	50	90	190	212	107	L1HZ-2790200000000
3000K	50	90	210	230	116	L1HZ-3090200000000
3500K	50	90	210	237	120	L1HZ-3590200000000
4000K	50	90	220	240	121	L1HZ-4090200000000
5000K	50	90	220	245	124	L1HZ-5090200000000
5700K	50	90	220	245	124	L1HZ-5790200000000

**Notes for Table 1:**

1. Lumileds maintains a tolerance of ±2 on CRI.
2. Lumileds maintains a tester tolerance of ±6.5% on luminous flux measurements.
3. Lumileds maintains a tester tolerance of ±6.5 on R9 measurements.

## Optical Characteristics

Table 2. Optical characteristics for LUXEON HL2Z at 700mA, T<sub>j</sub>=85°C.

PART NUMBER	TYPICAL TOTAL INCLUDED ANGLE <sup>[1]</sup>	TYPICAL VIEWING ANGLE <sup>[2]</sup>
L1HZ-xyy2zzzzzzzz	136°	120°

**Notes for Table 2:**

1. Total angle at which 90% of total luminous flux is captured.
2. Viewing angle is the off axis angle from the LED centerline where the luminous intensity is ½ of the peak value.

## Electrical and Thermal Characteristics

Table 3. Electrical and thermal characteristics for LUXEON HL2Z at 700mA, T<sub>j</sub>=85°C.

PART NUMBER	FORWARD VOLTAGE <sup>[1]</sup> (V <sub>f</sub> )			TYPICAL TEMPERATURE COEFFICIENT OF FORWARD VOLTAGE <sup>[2]</sup> (mV/°C)	TYPICAL THERMAL RESISTANCE—JUNCTION TO SOLDER PAD (°C/W)
	MINIMUM	TYPICAL	MAXIMUM		
L1HZ-xyy2zzzzzzzz	2.65	2.80	3.00	-1.4	1.7

**Notes for Table 3:**

1. Lumileds maintains a tolerance of ±0.1V on forward voltage measurements.
2. Measured between 25°C and 110°C.

## Absolute Maximum Ratings

Table 4. Absolute maximum ratings for LUXEON HL2Z.

PARAMETER	MAXIMUM PERFORMANCE
DC Forward Current <sup>[1, 2, 5]</sup>	1400mA
Peak Pulsed Forward Current <sup>[1, 3]</sup>	2000mA
LED Junction Temperature <sup>[1]</sup> (DC & Pulse)	135°C
ESD Sensitivity (ANSI/ESDA/JEDEC JS-001-2012)	Class 1C
Operating Case Temperature <sup>[1]</sup>	-40°C to 125°C
LED Storage Temperature	-40°C to 125°C
Soldering Temperature	JEDEC 020c 260°C
Allowable Reflow Cycles	3
Reverse Voltage <sup>[4]</sup> (V <sub>reverse</sub> )	LUXEON LEDs are not designed to be driven in reverse bias

**Notes for Table 4:**

1. Proper current derating must be observed to maintain the junction temperature below the maximum allowable junction temperature.
2. Residual periodic variations due to power conversion from alternating current (AC) to direct current (DC), also called "ripple," with frequencies ≥100Hz and amplitude ≤15% of the maximum allowable DC forward current are acceptable, assuming the average current throughout each cycle does not exceed the maximum allowable DC forward current at the corresponding maximum junction temperature.
3. Pulsed operation with a peak drive current equal to the stated peak pulsed forward current is acceptable if the pulse on-time is ≤5ms per cycle and the duty cycle is ≤50%.
4. Transient reverse voltages and surge currents due to electrical switching or supply interruptions are acceptable if these events do not last for more than 10ms, the amplitude of the reverse voltage does not exceed 5V and the reverse current is less than 220uA.
5. For torch application with portable battery source, maximum surge transient current during the initial turn-on is 3.5A for 180ms and thereafter not to exceed DC maximum rating current and LED junction temperature.

# Characteristic Curves

## Spectral Power Distribution Characteristics

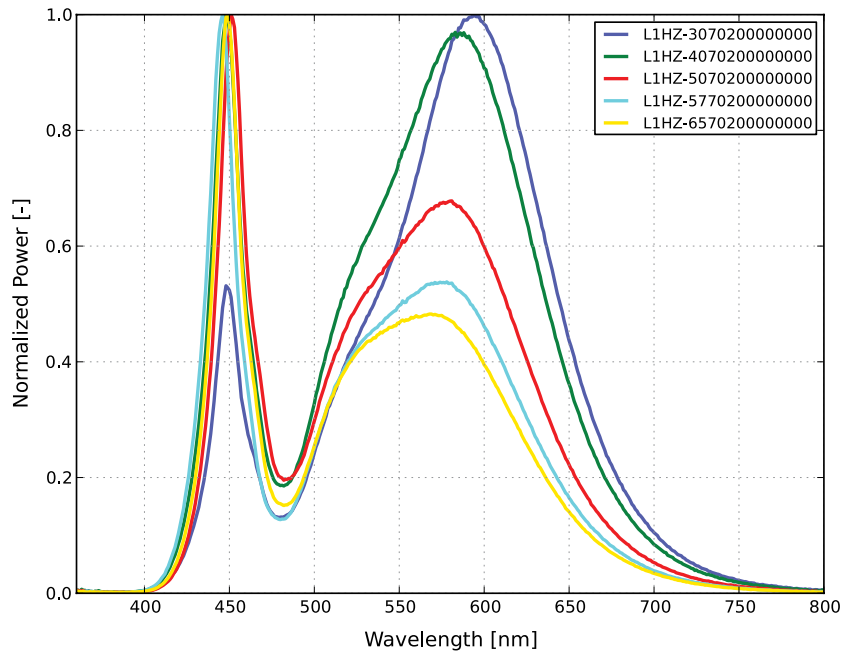

Figure 1. Typical normalized power vs. wavelength for LUXEON HL2Z 70CRI at 700mA,  $T_j=85^\circ\text{C}$ .

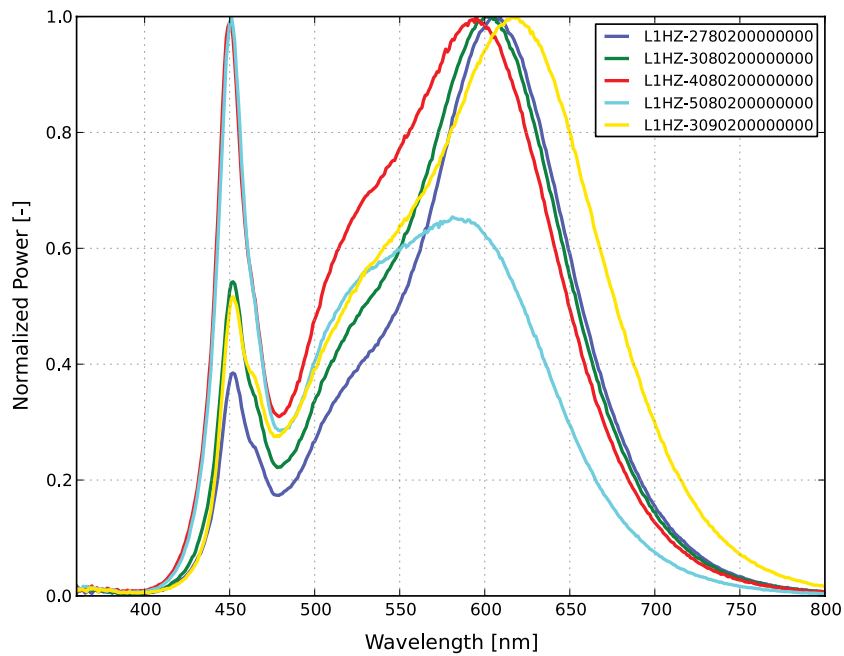

Figure 2. Typical normalized power vs. wavelength for LUXEON HL2Z 80CRI at 700mA,  $T_j=85^\circ\text{C}$ .

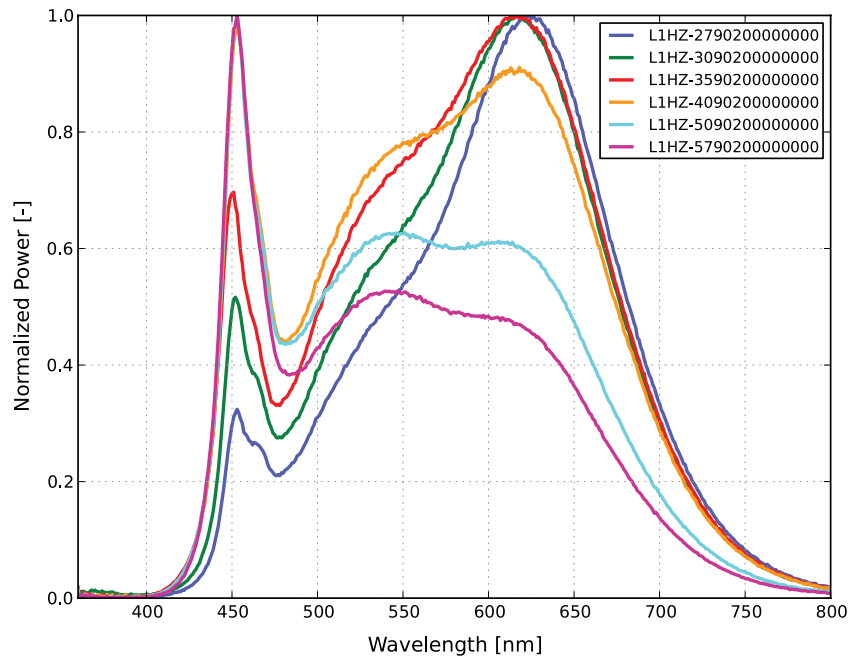

Figure 3. Typical normalized power vs. wavelength for LUXEON HL2Z 90CRI at 700mA,  $T_j=85^\circ\text{C}$ .

## Light Output Characteristics

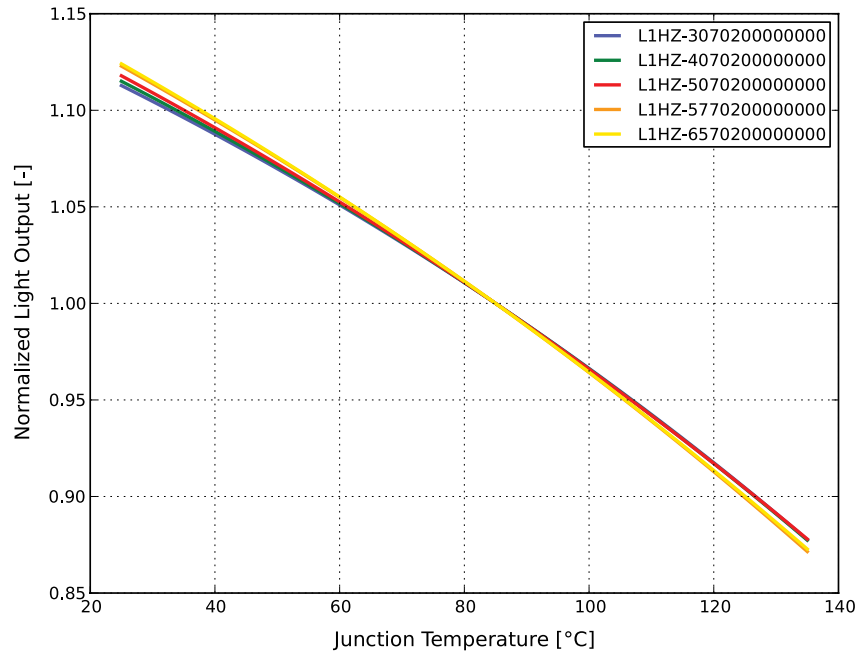

Figure 4. Typical normalized light output vs. junction temperature for LUXEON HL2Z 70 CRI at 700mA.

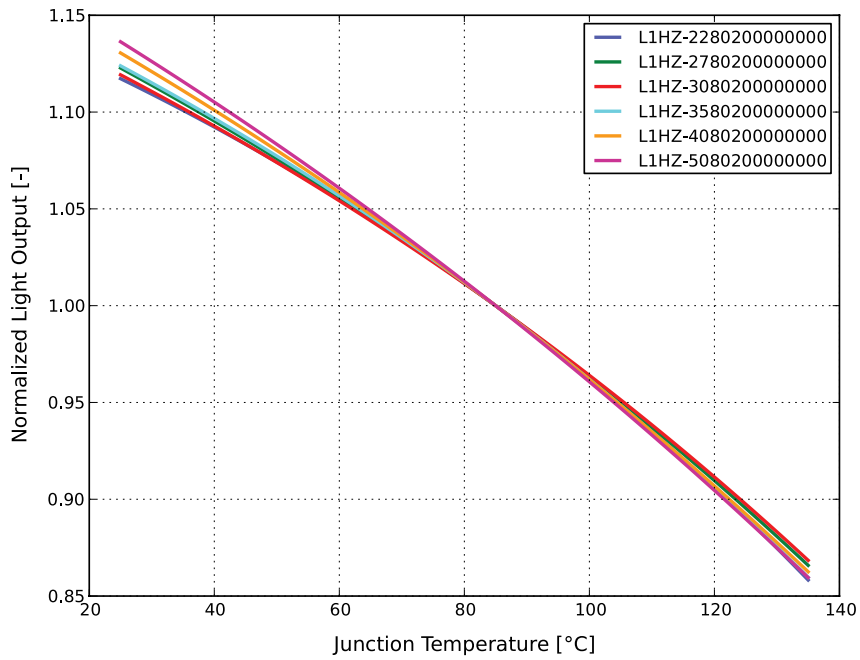

Figure 5. Typical normalized light output vs. junction temperature for LUXEON HL2Z 80 CRI at 700mA.

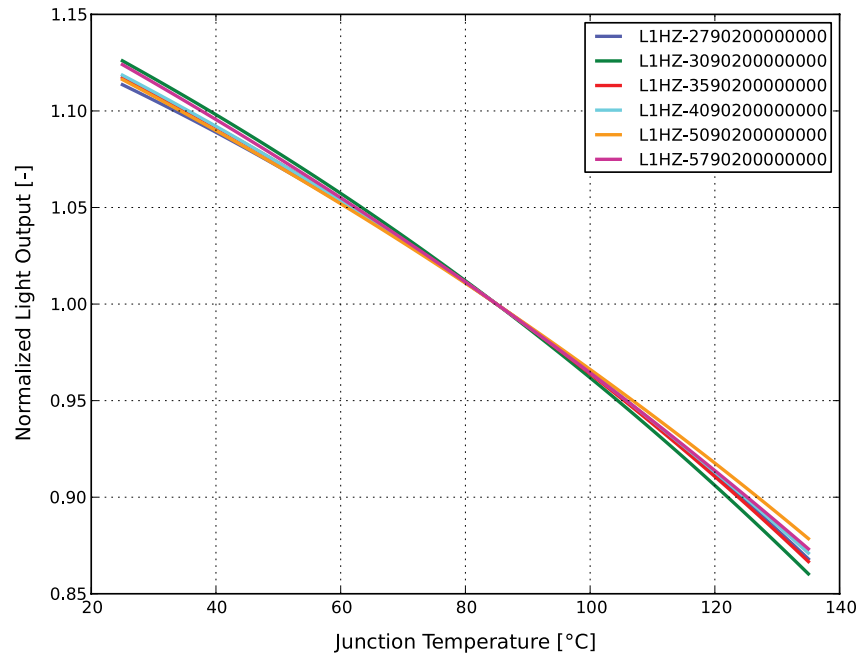

Figure 6. Typical normalized light output vs. junction temperature for LUXEON HL2Z 90 CRI at 700mA.



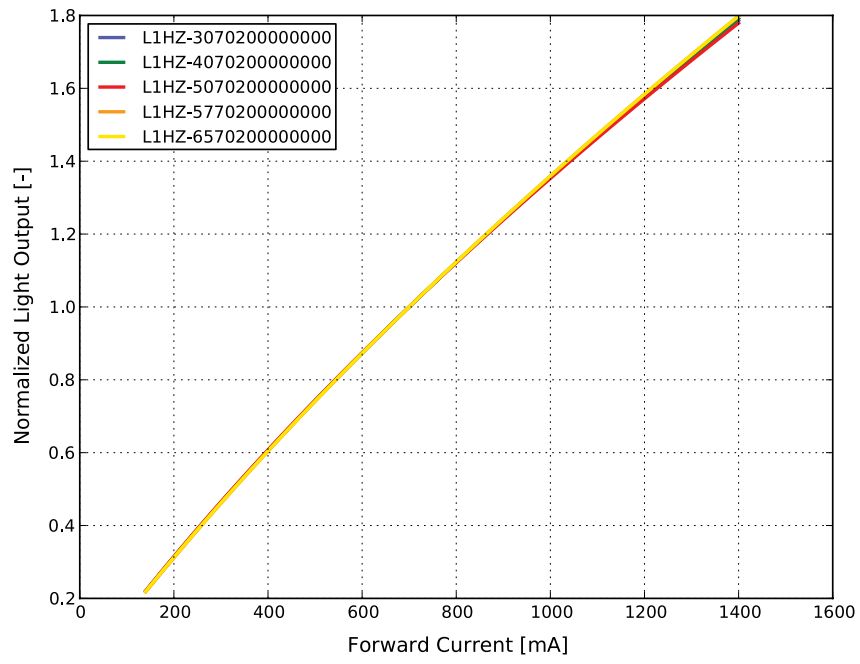

Figure 7. Typical normalized light output vs. forward current for LUXEON HL2Z 70 CRI at 700mA,  $T_j=85^\circ\text{C}$ .

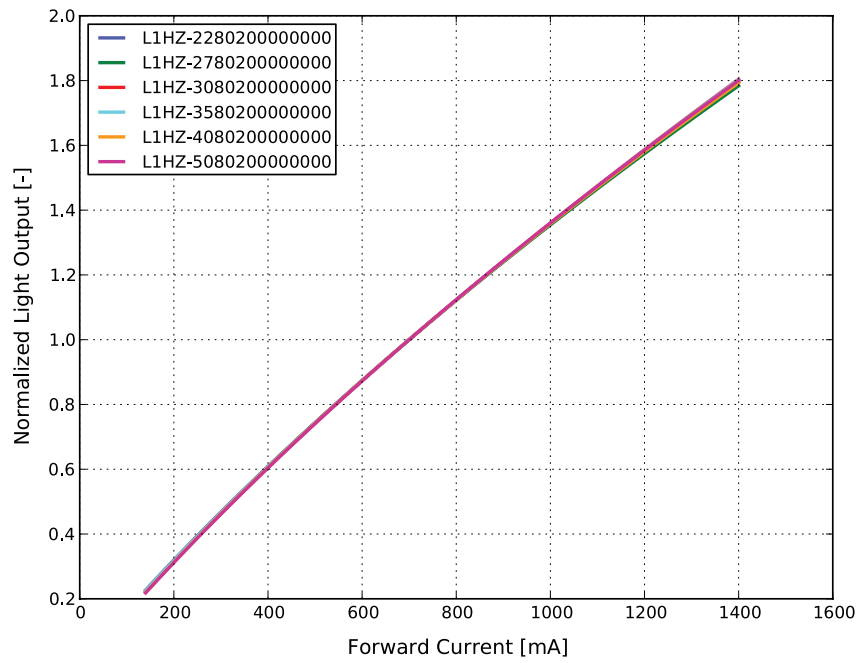

Figure 8. Typical normalized light output vs. forward current for LUXEON HL2Z 80 CRI at 700mA,  $T_j=85^\circ\text{C}$ .

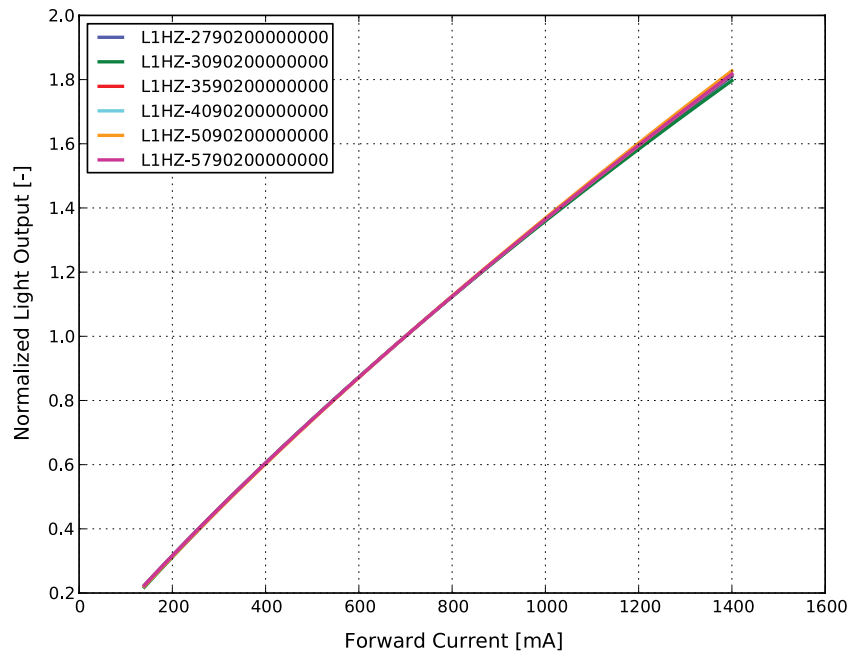

Figure 9. Typical normalized light output vs. forward current for LUXEON HL2Z 90 CRI at 700mA,  $T_j=85^\circ\text{C}$ .

## Forward Current Characteristics

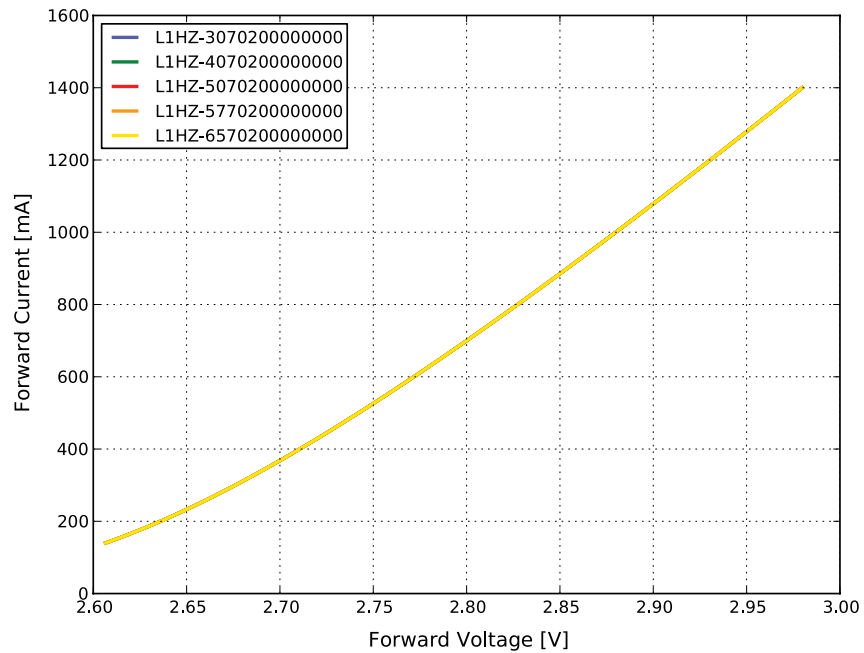

Figure 10. Typical forward current vs. forward voltage for LUXEON HL2Z 70 CRI at  $T_j=85^\circ\text{C}$ .

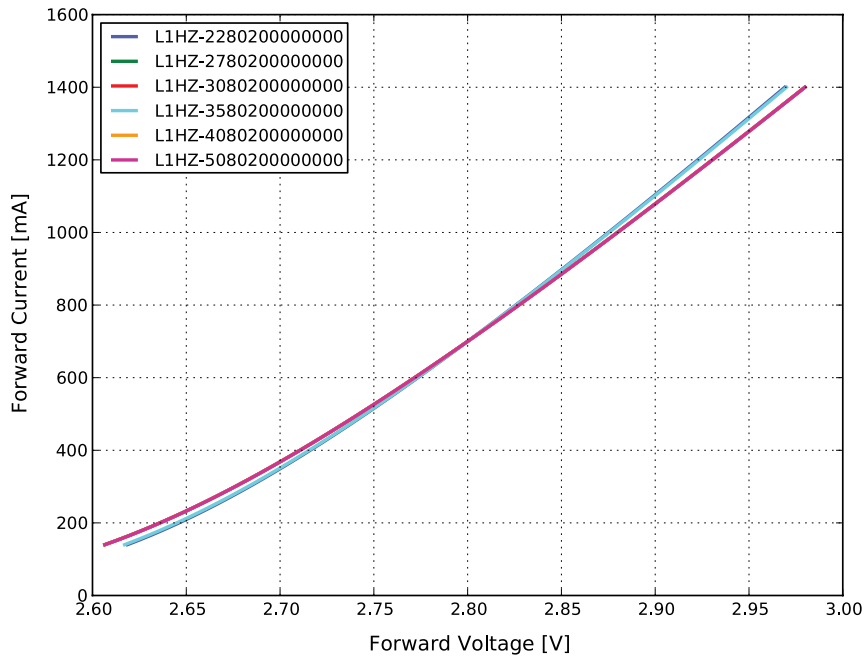

Figure 11. Typical forward current vs. forward voltage for LUXEON HL2Z 80 CRI at  $T_j=85^\circ\text{C}$ .

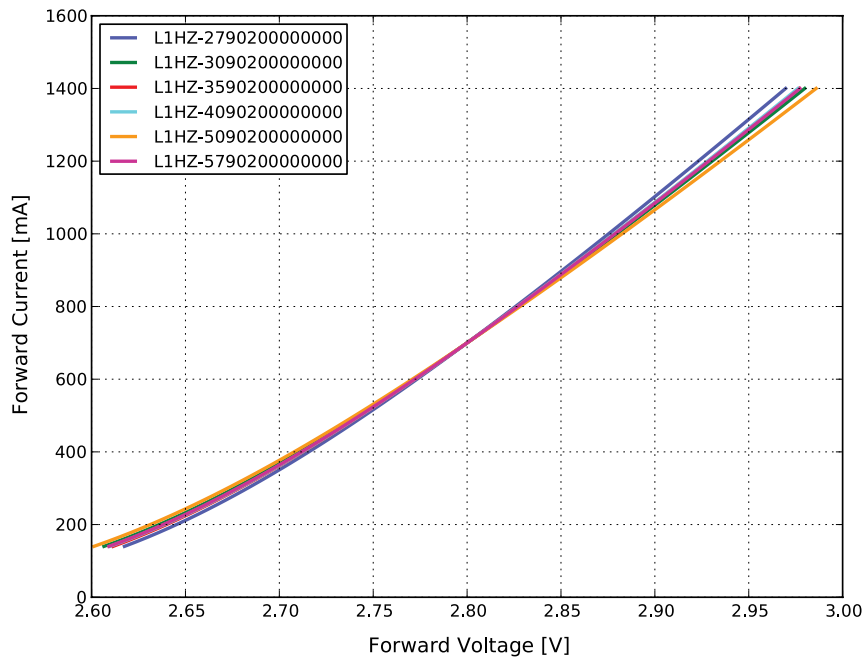

Figure 12. Typical forward current vs. forward voltage for LUXEON HL2Z 90 CRI at  $T_j=85^\circ\text{C}$ .

# Radiation Pattern Characteristics

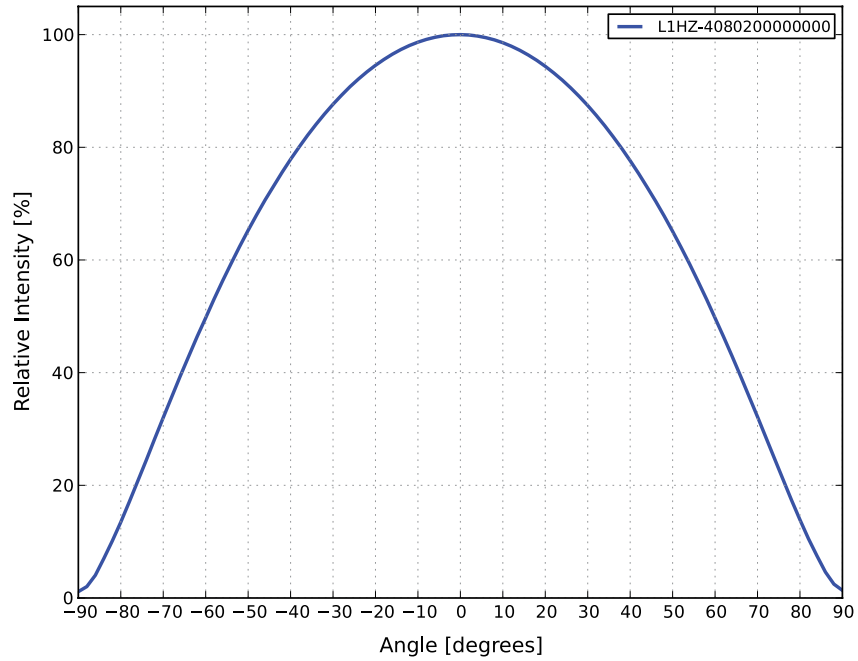

Figure 13. Typical radiation pattern for LUXEON HL2Z at 700mA,  $T_j=85^\circ\text{C}$ .

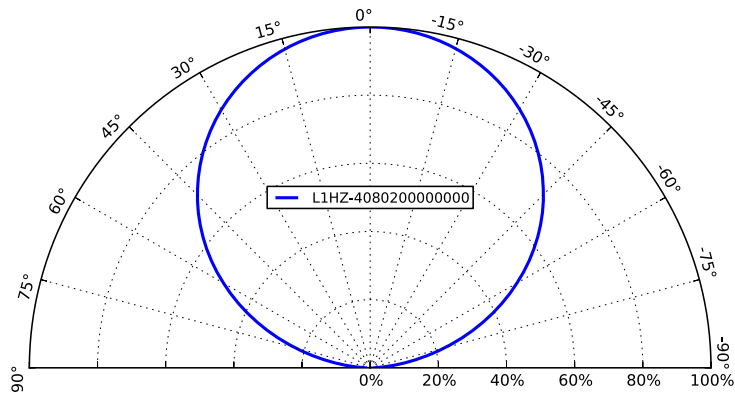

Figure 14. Typical polar radiation pattern for LUXEON HL2Z at 700mA,  $T_j=85^\circ\text{C}$ .

# Product Bin and Labeling Definitions

## Decoding Product Bin Labeling

In the manufacturing of semiconductor products, there are variations in performance around the average values given in the technical datasheet. For this reason, Lumileds bins LED components for luminous flux or radiometric power, color point, peak or dominant wavelength and forward voltage.

LUXEON HL2Z LEDs are labeled using a 4-digit alphanumeric CAT code following the format below:

### **A B C D**

Where:

- A** – designates luminous flux bin (example: V=290 to 300 lm, W=300 to 310 lm)
- B** – designates color bin (example: 1=6500K, 2=5700K, 3=5000K, 5=4000K, 7=3000K, 8=2700K)
- C** – designates color space (example: 5/A/B/C/D=5-step MacAdam ellipse, 3=3-step MacAdam ellips)
- D** – designates forward voltage bin (example: X=2.65 to 2.85V, Y=2.85 to 3.00V)

Therefore, a LUXEON HL2Z 3000K 70CRI with a lumen range of 290 to 300 lm, color bin of 75 and a forward voltage range of 2.65 to 2.85V has the following CAT code:

### **V 7 5 X**

## Luminous Flux Bins

Table 5 lists the standard luminous flux bins for LUXEON HL2Z emitters. Although several bins are outlined, product availability in a particular bin varies by production run and by product performance. Not all bins are available in all CCTs.

**Table 5. Luminous flux bin definitions for LUXEON HL2Z.**

BIN	LUMINOUS FLUX <sup>(1)</sup> (lm)	
	MINIMUM	MAXIMUM
K	190	200
L	200	210
M	210	220
N	220	230
P	230	240
Q	240	250
R	250	260
S	260	270
T	270	280
U	280	290
V	290	300
W	300	310
X	310	320
Y	320	330
Z	330	340
A	340	350
B	350	360
C	360	370

**Notes for Table 5:**

1. Lumileds maintains a tolerance of  $\pm 6.5\%$  on luminous flux measurements.

# Color Bin Definitions

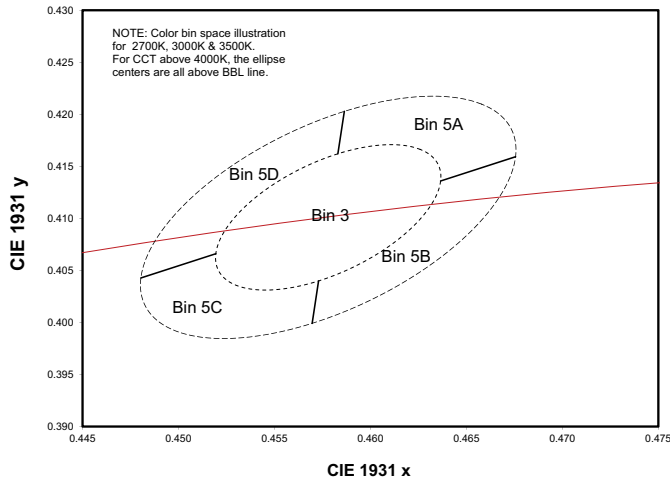

Figure 15. Color space definition for LUXEON HL2Z.

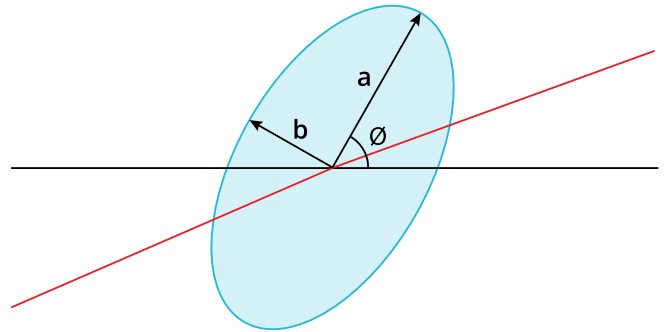

Figure 16. 5-step MacAdam ellipse illustration for Table 6.

Table 6. 3-step & 5-step MacAdam ellipse color bin definitions for LUXEON HL2Z.

NOMINAL CCT	COLOR SPACE	CENTER POINT <sup>[1]</sup> (cx, cy)	MAJOR AXIS, a	MINOR AXIS, b	ELLIPSE ROTATION ANGLE, θ
2700K	Single 3-step & 5-step MacAdam ellipse	(0.4578, 0.4101)	0.013500	0.007000	53.70°
3000K	Single 3-step & 5-step MacAdam ellipse	(0.4338, 0.4030)	0.013 900	0.006 800	53.22°
3500K	Single 3-step & 5-step MacAdam ellipse	(0.4073, 0.3917)	0.015 450	0.006 900	54.0°
4000K	Single 3-step & 5-step MacAdam ellipse	(0.3818, 0.3797)	0.015 650	0.006 700	53.72°
5000K	Single 3-step & 5-step MacAdam ellipse	(0.3447, 0.3553)	0.013 700	0.005 900	59.62°
5700K	Single 3-step & 5-step MacAdam ellipse	(0.3287, 0.3417)	0.012 425	0.005 325	59.09°
6500K	Single 3-step & 5-step MacAdam ellipse	(0.3123, 0.3282)	0.011 150	0.004 750	58.57°

Notes for Table 6:

1. Lumileds maintains a tolerance of ±0.005 on x and y coordinates in the CIE 1931 color space.

Table 7. Correlated color temperature bin definitions for LUXEON HL2Z.

BIN	CCT
1	6500K
2	5700K
3	5000K
5	4000K
6	3500K
7	3000K
8	2700K

Table 8. MacAdam ellipse color space definitions for LUXEON HL2Z.

BIN	SDCM
3	3-step MacAdam ellipse (70, 80, 90 CRI)
5	5-step MacAdam ellipse (70 CRI)
A	5-step MacAdam ellipse (80,90 CRI)
B	5-step MacAdam ellipse (80,90 CRI)
C	5-step MacAdam ellipse (80,90 CRI)
D	5-step MacAdam ellipse (80,90 CRI)

# Forward Voltage Bins

Table 9. Forward voltage bin definitions for LUXEON HL2Z.

BIN	FORWARD VOLTAGE <sup>(1)</sup> (V <sub>f</sub> )	
	MINIMUM	MAXIMUM
X	2.65	2.85
Y	2.85	3.00

Notes for Table 9:

1. Lumileds maintains a tolerance of ±0.1V on forward voltage measurements.

# Mechanical Dimensions

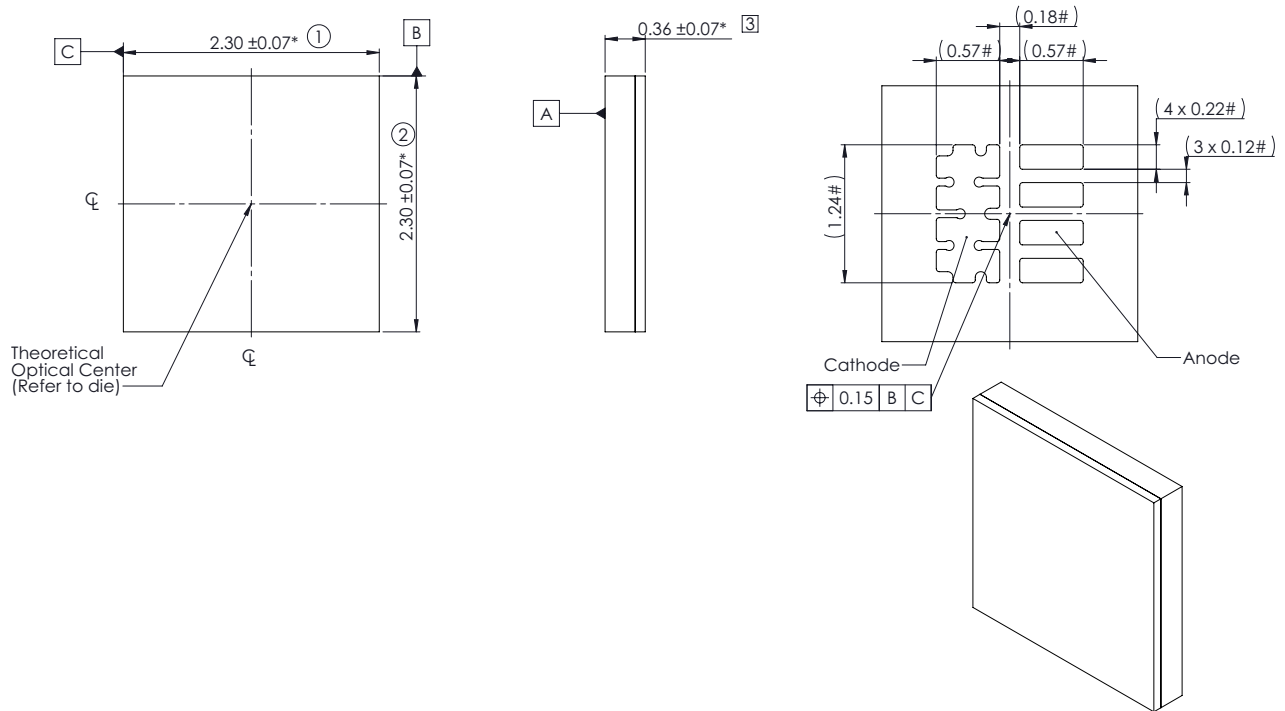

Figure 17. Mechanical dimensions for LUXEON HL2Z.

Notes for Figure 17:

1. Drawings are not to scale.
2. All dimensions are in millimeters.
3. Do not handle the device by the dome. Excessive force on the dome may damage the dome itself or the interior of the device.



# Reflow Soldering Guidelines

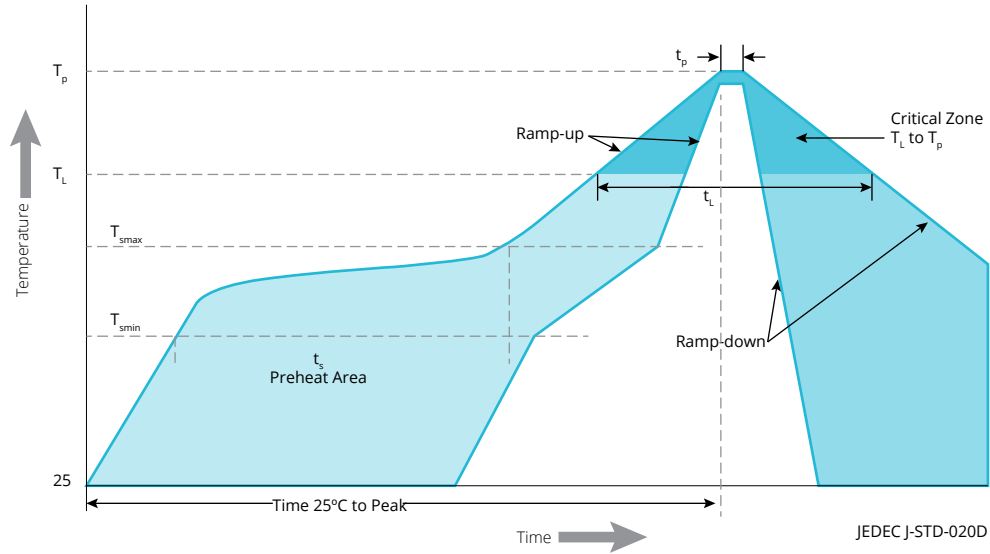

Figure 18. Visualization of the acceptable reflow temperature profile as specified in Table 10.

Table 10. Reflow profile characteristics for LUXEON HL2Z.

PROFILE FEATURE	LEAD-FREE ASSEMBLY
Preheat Minimum Temperature ( $T_{smin}$ )	150°C
Preheat Maximum Temperature ( $T_{smax}$ )	200°C
Preheat Time ( $t_{smin}$ to $t_{smax}$ )	60 to 180 seconds
Ramp-Up Rate ( $T_L$ to $T_p$ )	3°C / second maximum
Liquidous Temperature ( $T_L$ )	217°C
Time Maintained Above Temperature $T_L$ ( $t_t$ )	60 to 150 seconds
Peak / Classification Temperature ( $T_p$ )	260°C
Time Within 5°C of Actual Peak Temperature ( $t_p$ )	20 to 40 seconds
Ramp-Down Rate ( $T_p$ to $T_L$ )	6°C / second maximum
Time 25°C to Peak Temperature	8 minutes maximum

**Notes for Table 10:**

1. All temperatures refer to the application Printed Circuit Board (PCB), measured on the surface adjacent to the package body.

## JEDEC Moisture Sensitivity

Table 11. Moisture sensitivity levels for LUXEON HL2Z.

LEVEL	FLOOR LIFE		SOAK REQUIREMENTS STANDARD	
	TIME	CONDITIONS	TIME	CONDITIONS
1	Unlimited	≤30°C / 85% RH	168 Hours +5 / -0	85°C / 85% RH

# Solder Pad Design

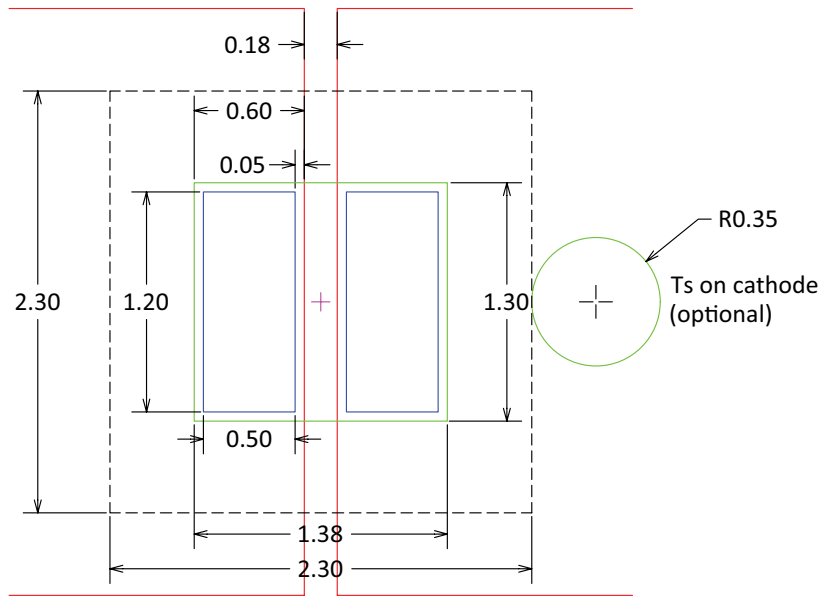

- solder mask
- stencil
- top copper
- package center
- LED outline

Figure 19. Recommended PCB solder pad layout for LUXEON HL2Z.

- Notes for Figure 19:
1. Drawings are not to scale.
  2. All dimensions are in millimeters.

# Packaging Information

## Pocket Tape Dimensions

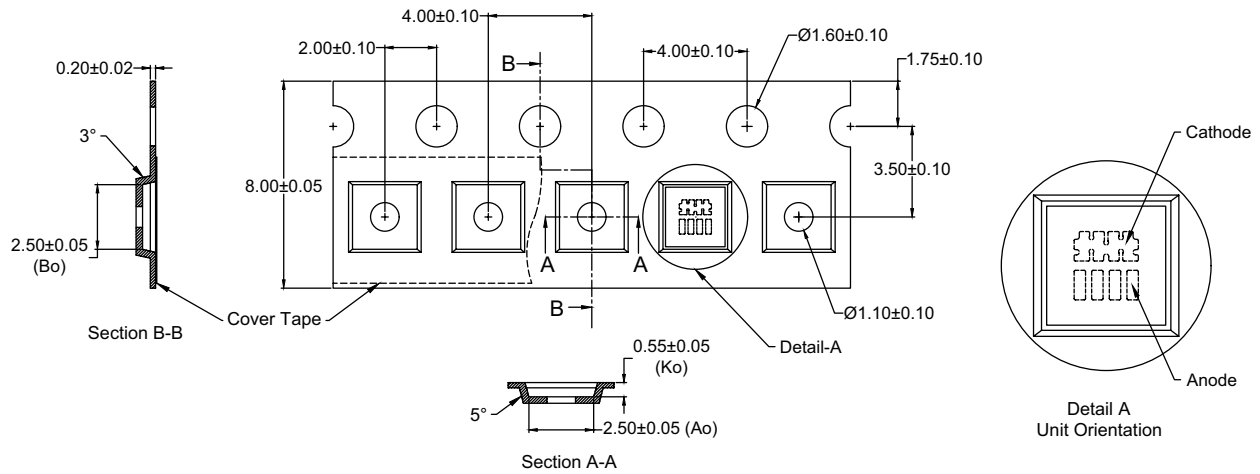

Figure 20. Pocket tape dimensions for LUXEON HL2Z.

**Notes for Figure 20:**

1. Drawings are not to scale.
2. All dimensions are in millimeters.

## Reel Dimensions

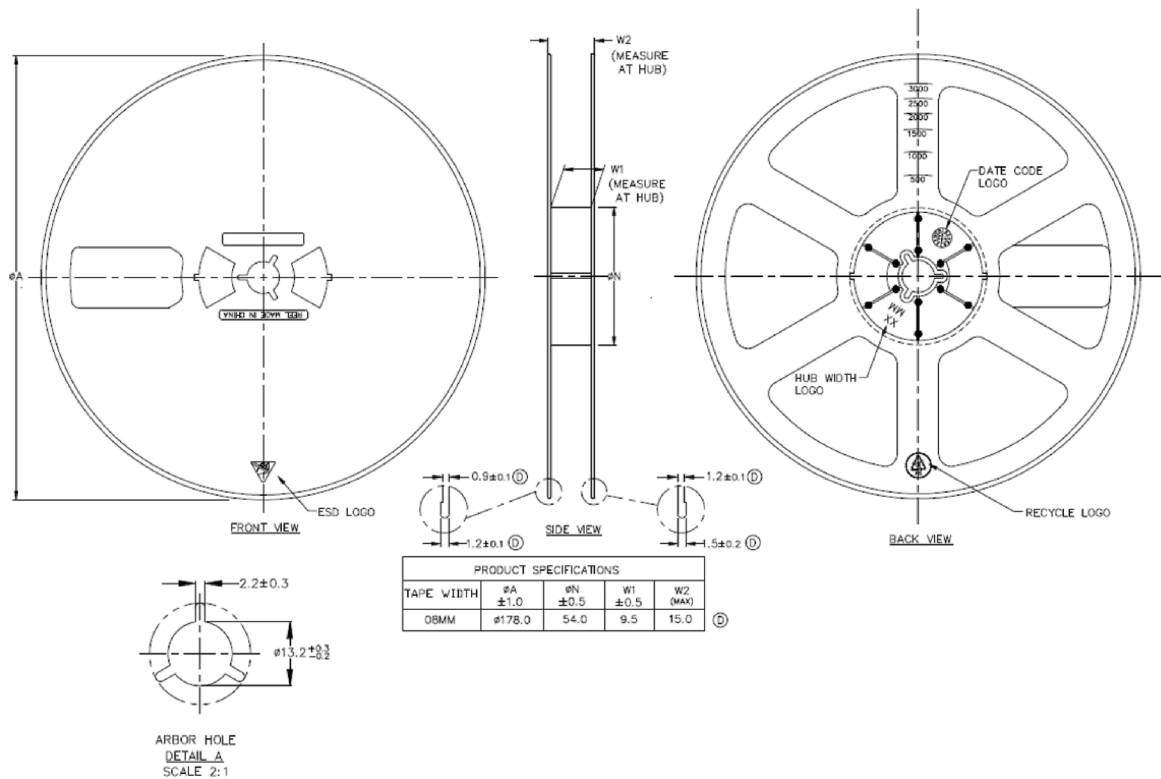

Figure 21. Reel dimensions for LUXEON HL2Z.

**Notes for Figure 21:**

1. Drawings are not to scale.
2. All dimensions are in millimeters.
3. 4,000 pieces per reel.

## About Lumileds

Companies developing automotive, mobile, IoT and illumination lighting applications need a partner who can collaborate with them to push the boundaries of light. With over 100 years of inventions and industry firsts, Lumileds is a global lighting solutions company that helps customers around the world deliver differentiated solutions to gain and maintain a competitive edge. As the inventor of Xenon technology, a pioneer in halogen lighting and the leader in high performance LEDs, Lumileds builds innovation, quality and reliability into its technology, products and every customer engagement. Together with its customers, Lumileds is making the world better, safer, more beautiful—with light.

To learn more about our lighting solutions, visit [lumileds.com](http://lumileds.com).



©2022 Lumileds Holding B.V. All rights reserved.  
LUXEON is a registered trademark of the Lumileds Holding B.V. in the United States and other countries.

[lumileds.com](http://lumileds.com)

Neither Lumileds Holding B.V. nor its affiliates shall be liable for any kind of loss of data or any other damages, direct, indirect or consequential, resulting from the use of the provided information and data. Although Lumileds Holding B.V. and/or its affiliates have attempted to provide the most accurate information and data, the materials and services information and data are provided “as is,” and neither Lumileds Holding B.V. nor its affiliates warrants or guarantees the contents and correctness of the provided information and data. Lumileds Holding B.V. and its affiliates reserve the right to make changes without notice. You as user agree to this disclaimer and user agreement with the download or use of the provided materials, information and data. A listing of Lumileds product/patent coverage may be accessed at [lumileds.com/patents](http://lumileds.com/patents).