

Shorting Socket: 58-9159-002-000-006

General Description

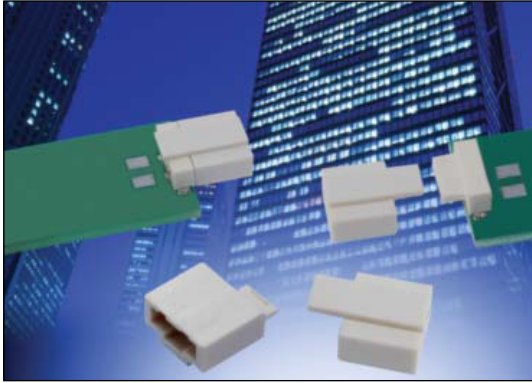

The 9159 series of Board-to-Board interconnect system allows two PCB's to be mated end-to-end creating strips of LED lighting. Designed specifically for the unique Solid State Lighting (SSL) market requiring coplanar (horizontal-to-horizontal) PCB mating with a 5 Amp current rating in the smallest package available. The 2 position shorting socket was designed to plug onto the last PCB in the lighting strip to short the two contacts together, closing the electrical loop. Just as the cabled plug brings power and signals onto the light strip, the shorting socket completes the circuit while maintaining a single board design.

APPLICATIONS

- Coplanar PCB mating in SSL products
- LED linear lighting strips
- Application Notes: refer to 201-01-123
- Product Specification: refer to 201-01-119

FEATURES AND BENEFITS

- Mates to the standard plug connector: does not require a new connector
- Integral latching mechanism: Provides positive attachment to the plug
- Gold plated BeCu spring contacts: reliability for harsh environments
- Available in white: supports SSL market preferences

ELECTRICAL

- Current Rating: 5 Amps / Contact
- Voltage Rating: 125 VAC (RMS) or DC Equivalent

ENVIRONMENTAL

- Operating Temperature: -40°C to +125°C
- Storage Temperature: -40°C to +70°C

MECHANICAL

- Insulator Material: Nylon: VL94VO
- Contact Material: BeCu / Phos Bronze
- Plating: Gold / Tin over Nickel
- Durability: 10 Cycles

HOW TO ORDER

58 9159 002 000 006



Safety Standards: UL 1977-File #E90723

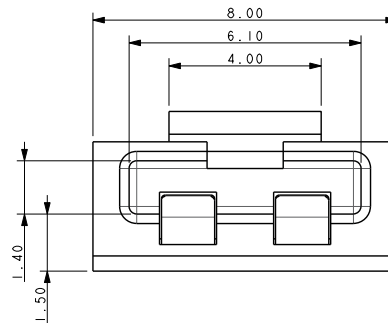
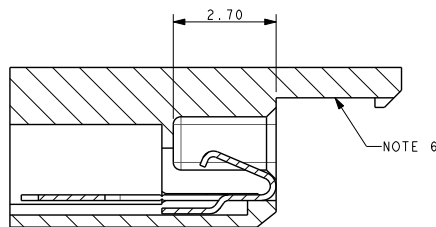
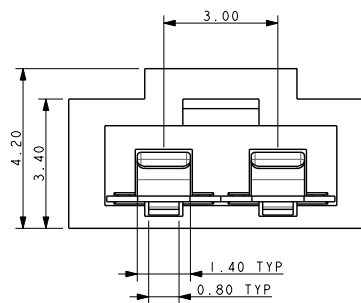
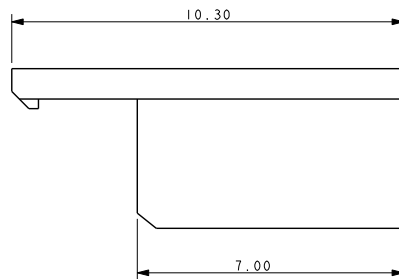
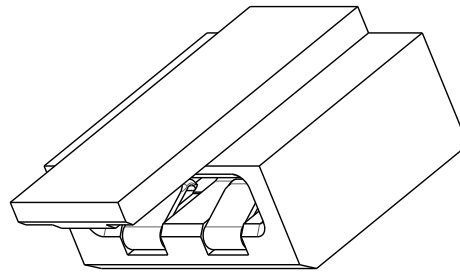

PACKING DETAILS

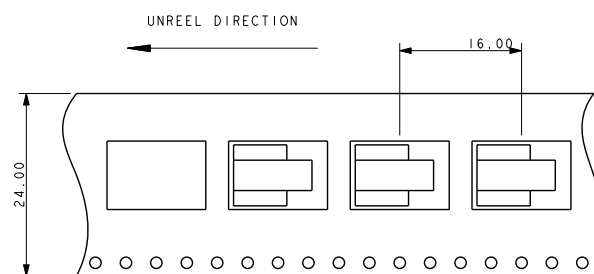
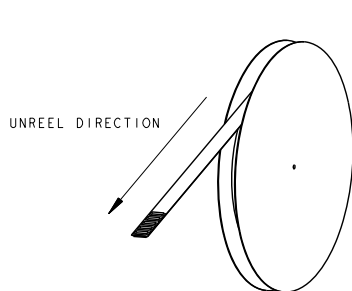

NOTES:

1. SHORTING LINK TO MATCH 9159 2 WAY PLUG CONNECTORS
2. FOR MORE INFORMATION REFER TO SPECIFICATION 201-01-119UL
3. INSULATOR MATERIAL: NYLON 46 COLOUR WHITE.
4. CONTACT MATERIAL: BERYLIUM COPPER TM04.
5. CONTACT PLATING: BRIGHT NICKEL ALL OVER, GOLD ON CONTACT NOSE.
6. LATCH TO ENGAUGE AND LOCK ONTO 2 WAY PLUG CONNECTORS, ALSO PREVENTS INCORRECT ORIENTATION
7. PACKING TAPE AND REEL, QUANTITY 700 PER REEL.
8. UL REFERENCE E90723