



Surface Mount Oven Stabilized Oscillator DOCAT Series

OCXO or VCOCXO

CONNOR WINFIELD



2111 Comprehensive Drive

Aurora, Illinois 60505

Phone: 630-851-4722

Fax: 630-851-5040

www.conwin.com

Description:

Connor-Winfield's high stability DOCAT Series is an exceptionally precise frequency standard, excellent for use in cellular base stations, test equipment, Synchronous Ethernet and VSAT applications.

Based on an AT-cut crystal, the DOCAT Series offers low aging and tight stability in a 9x14mm surface mount package.



Features:

- OCXO or VCOCXO
- 3.3 Vdc Operation
- SMT Package
- Frequency Stabilities: ± 20 ppb, ± 50 ppb and ± 100 ppb
- Temperature Ranges: 0 to 70°C, -20 to 75°C, -40 to 85°C or -40 to 70°C
- Low Phase Noise
- LVCMOS Output
- RoHS Compliant / Lead Free

Package Outline

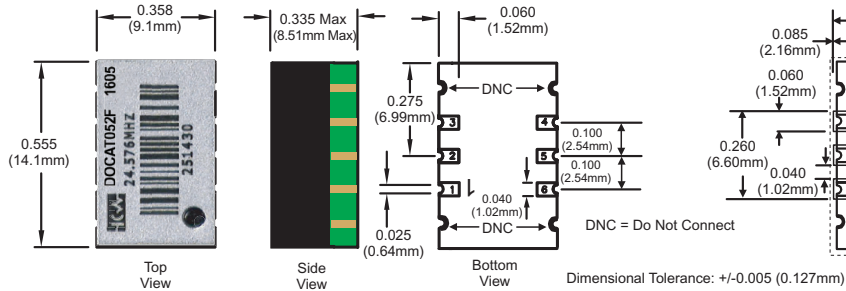

Suggested Pad Layout

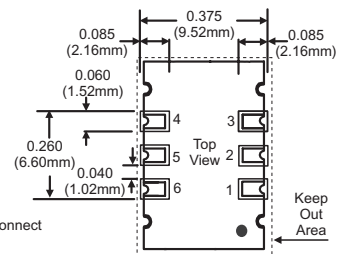

Pad Connections

- | | |
|----|------------------------|
| 1: | N/C or Voltage Control |
| 2: | Do Not Connect* |
| 3: | Ground |
| 4: | Output |
| 5: | Do Not Connect* |
| 6: | Supply Voltage (Vcc) |

* Do Not Connect: Pins used for Internal Programming.

Ordering Information

DOCAT	02	0	F	-024.576M
Oscillator Type 3.3 Vdc LVCMOS Output Surface Mount OCXO	Frequency Stability 02 = ± 20 ppb 05 = ± 50 ppb 10 = ± 100 ppb	Temperature Range 0 = 0 to 70°C 1 = -20 to 75°C 2 = -40 to 85°C 3 = -40 to 70°C	Voltage Control Option F = OCXO (Fixed Freq.) V = VCOCXO (Voltage Controlled)	Output Frequency Frequency Format -xxx.xM Min * -xxx.xxxxxxM Max * *1 digit min, 6 digits max after the decimal point.

Note: Frequency stability ± 20 ppb over temperature range -40/85°C is not available in all frequencies. Contact factory for details.



Bulletin	Cx275
Page	1 of 4
Revision	04
Date	18 June 2019



Attention: System Designers please review Application Note AN2093:
System Design Information and Printed Circuit Board Layout Guidelines for OCXO Oscillators.
www.conwin.com/support.html



Absolute Maximum Ratings

Parameter	Minimum	Nominal	Maximum	Units	Notes
Storage Temperature	-55	-	125	°C	
Supply Voltage - 3.3 Vdc (Vcc)	-0.5	-	4.5	Vdc	
Control Voltage (Vc)	-0.5	-	Vcc+0.5	Vdc	

Operating Specifications

Parameter	Minimum	Nominal	Maximum	Units	Notes
Center Frequency (Fo)	10	-	50	MHz	
Frequency Stability vs. Change in Temperature					
Option 02	-20	-	20	ppb	1
Option 05	-50	-	50	ppb	
Option 10	-100	-	100	ppb	
Operating Temperature Range					
Option 0	0	-	70	°C	
Option 1	-20	-	75	°C	
Option 2	-40	-	85	°C	
Option 3	-40	-	70	°C	
Frequency Calibration	-1.0	-	1.0	ppm	2
Frequency Stability vs Load	-20	-	20	ppb	±5%
Frequency Stability vs Voltage	-20	-	20	ppb	±5%
Aging: Daily	-10	-	10	ppb/day	3
Aging: First Year	-0.5	-	0.5	ppm	
Total Frequency Tolerance (20 Years)	-4.6	-	4.6	ppm	4
Supply Voltage (Vcc)	3.13	3.30	3.47	Vdc	5
Power Consumption Vcc = Nominal Voltage					
Commercial Temperature Range: 0 to 70 °C					
Turn On	-	-	2.5	W	
Steady State @ 25°C	-	-	1.1	W	
Industrial Temperature Range: -40 to 85 °C					
Turn On	-	-	3.0	W	
Steady State @ 25°C	-	-	1.3	W	
Phase Jitter: (BW: 12 KHz to Fo/2 MHz @ Fo=40.0MHz)	-	0.25	0.35	ps RMS	
Allan Deviation (Tau=1s) Fo=20MHz	-	1.0E-10	-		
Start-Up Time	-	-	10	ms	
Warm Up Time (Within Calibration @ 25°C)	-	-	60	s	
Warm Up Time (Within Calibration @ -40°C)	-	-	90	s	

CMOS Output Characteristics

Parameter	Minimum	Nominal	Maximum	Units	Notes
Load	-	15	-	pF	6
Output Voltage					
Output Voltage: High (Voh)	2.7	-	-	V	
Low (Vol)	-	-	0.3	V	
Output Current: High (Ioh)	-4	-	-	mA	
Low (Iol)	-	-	4	mA	
Duty Cycle at 50% of Vcc	45	50	55	%	
Rise / Fall Time: 10% to 90%	-	-	6.5	ns	

Typical Phase Noise Characteristics

Parameter	Fo=10 MHz	Fo=24.576MHz	Fo=40.0MHz	Units	Notes
@ 1 Hz offset	-72	-70	-67	dBC/Hz	
@ 10 Hz offset	-100	-96	-90	dBC/Hz	
@ 100 Hz offset	-128	-125	-116	dBC/Hz	
@ 1 KHz offset	-145	-145	-139	dBC/Hz	
@ 10 KHz offset	-151	-151	-147	dBC/Hz	
@ 100 KHz offset	-154	-154	-153	dBC/Hz	
@ 1MHz offset	-155	-155	-153	dBC/Hz	



*Attention: System Designers please review Application Note AN2093:
System Design Information and Printed Circuit Board Layout Guidelines for OXCO Oscillators.
@ www.conwin.com/technologies.html*

Bulletin	Cx275
Page	2 of 4
Revision	04
Date	18 June 2019



Input Characteristics - Voltage Controlled Option

Parameter	Minimum	Nominal	Maximum	Units	Notes
Control Voltage Range:	0.30	1.65	3.00	V	7
Frequency Pullability:	±10.0	-	±15.0	ppm	8
Input Impedance	100K	-	-	Ohms	
Linearity	-	-	±5	%	

Package Characteristics

DOC Package Package consisting of a FR-4 substrate and Ryton-R-4 cover. Water Resistant package, non-hermetic seal. (Engineering Properties of Ryton R-4 Application Note AN2100)

Environmental Characteristics

Shock	500 G's 1ms, Halfsine, 3 shocks per direction, per MIL-STD 202G, Method 213B Test Condition D.
Sinusoidal Vibration	0.06" D.A. or 10G's Peak, 10 to 500 Hz, per MIL-STD-202G, Method 204D, Test Condition A.
Random Vibration	5.35 G's rms. 20 to 2000 Hz per MIL-STD-202G, Method 214, Test Condition 1A, 15 minutes each axis.
Moisture	10 cycles, 95% RH, Per MIL-STD-202G, Method 112.
Marking Permanency	Per MIL-STD-202G, Method 215J.
Solder Process Recommendations:	RoHS compliant, lead free. See solder profile on page 4.
In-line reflow:	Refer to recommended reflow pre-heat and reflow temperatures on page 4. Package material consist of Ryton R-4 high temperature cover with FR4 substrate. Component solder is Pb free high temperature eutectic alloy with a melting point of 221°C.
In-line oven profile:	We recommend using KIC profiler or similar device placing one of the thermocouples on the device to insure that the internal package temperature does not exceed 221°C.
Removal of device:	If for any reason the device needs to be removed from the board, use a temperature controlled repair station with profile monitoring capabilities. Following a monitored profile will insure the device is properly pre-heated prior to reflow. Refer to IPC 610E for inspection guidelines.

Recommended Cleaning Process: (If required)

Device is non-hermetic, water resistance with four weep holes, one in each corner to allow moisture to be removed during the drying cycle. We recommend in-line warm water wash with air knife and drying capabilities. If cleaner does not have drying capability, then use hot air circulated oven. Boards should be placed in the oven vertically for good water runoff.

Device must be dried properly prior to use!

Note: If saponifier is used make sure the device is rinsed properly to insure all residues are removed. PH of saponifier should not exceed 10.

Drying Temperature: Between 85 to 100°C.

Drying Time: Time will vary depending on the board size.

Caution: Do not submerge the device!

Notes:

1. Frequency stability vs. change in temperature. $[\pm(F_{max} - F_{min})/(2 \cdot F_0)]$.
2. Initial calibration @ 25°C. For OCXO with voltage control option, the control voltage must be fixed.
3. After 10 days of operation
4. Inclusive of calibration @ 25°C, frequency vs. change in temperature, change in supply voltage (±5%), load change (±5%), shock and vibration and 20 years aging
5. Minimum "Power On Time" after rail rises from 0 to within +/-5% of Vcc = 1 second. Vcc ramp rate must be <0.3 volts per millisecond.
6. Attention: To achieve optimal frequency stability, and in some cases to meet the specification stated on this data sheet, it is required that the circuit connected to this OCXO output must have the equivalent input capacitance that is specified by the nominal load capacitance. Deviations from the nominal load capacitance will have a graduated effect on the stability of approximately 20 ppb per pF load difference.
7. Positive slope. (Frequency increases as Vc voltage increases). To ensure proper operation of VCOCXO's, the control voltage input must be biased the nominal control voltage. Failure to bias the Vc input will cause an unstable output condition.
8. Referenced to Fo.



Attention: System Designers please review Application Note AN2093:
System Design Information and Printed Circuit Board Layout Guidelines for OCXO Oscillators.
@ www.conwin.com/technologies.html

Bulletin	Cx275
Page	3 of 4
Revision	04
Date	18 June 2019

Typical Phase Noise Plot DOCAT052F-020.0M

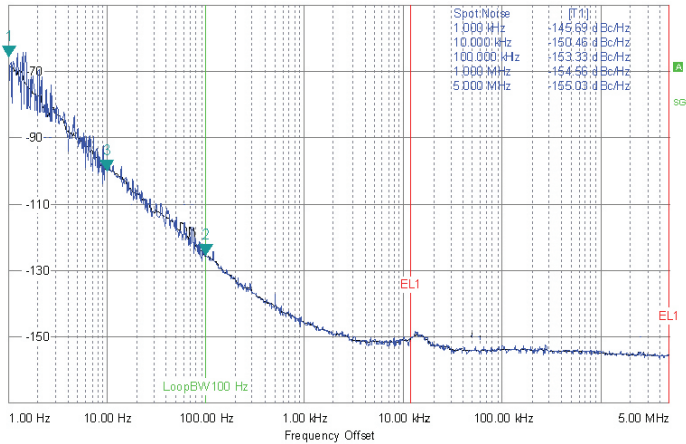

Allan Deviation Plot DOCAT052F-020.0M

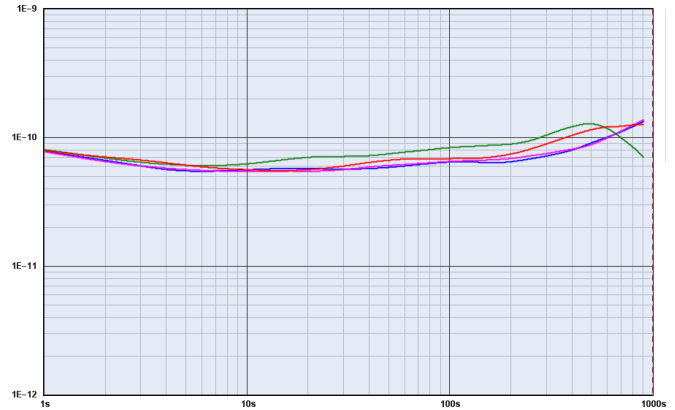

LVC MOS Test Circuit

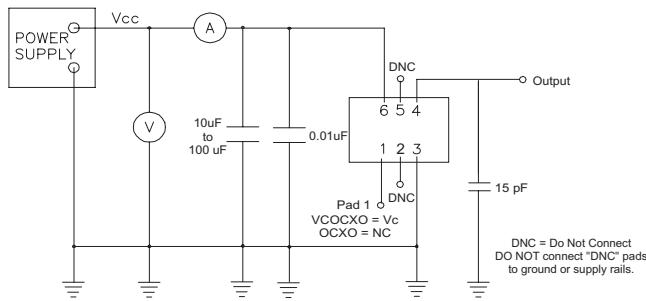

RoHS Solder Profile

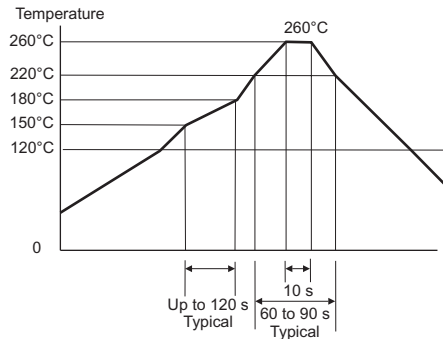

Meets IPC/JEDEC J-STD-020C

Tape and Reel Information

MEETS EIA-481A & EIAJ-1009B
 500 PCS/REEL MAXIMUM

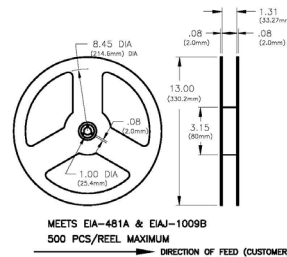
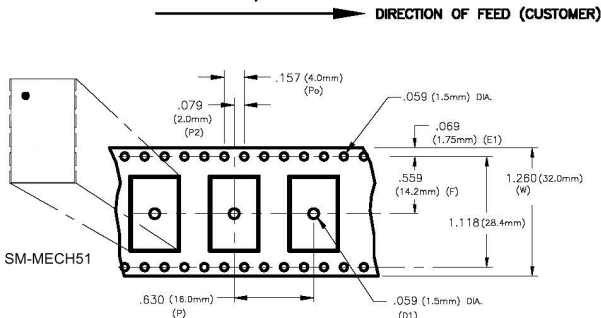

CMOS Output Waveform

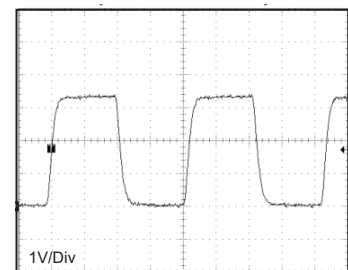

Attention: System Designers please review Application Note AN2093:
 System Design Information and Printed Circuit Board Layout Guidelines for OCXO Oscillators.
 @ www.conwin.com/technologies.html

Bulletin	Cx275
Page	4 of 4
Revision	04
Date	18 June 2019