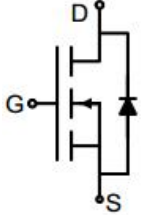
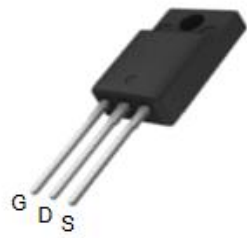

N-Channel Enhancement Mode Power MOSFET

<p>Description</p> <p>The 18N20F uses advanced trench technology to provide excellent $R_{DS(ON)}$, low gate charge. It can be used in a wide variety of applications.</p> <p>General Features</p> <ul style="list-style-type: none"> ● V_{DS} 200V ● I_D (at $V_{GS} = 10V$) 18A ● $R_{DS(ON)}$ (at $V_{GS} = 10V$) < 190mΩ ● 100% Avalanche Tested ● RoHS Compliant <p>Application</p> <ul style="list-style-type: none"> ● Power switch ● DC/DC converters 	 <p style="text-align: center;">Schematic diagram</p>  <p style="text-align: center;">TO-220F</p>
--	---

Ordering Information

Device	Package	Marking	Packaging
18N20F	TO-220F	18N20F	50pcs/Tube

Absolute Maximum Ratings $T_C = 25^\circ C$, unless otherwise noted

Parameter	Symbol	Value	Unit
Drain-Source Voltage	V_{DS}	200	V
Continuous Drain Current	I_D	18	A
Pulsed Drain Current (note1)	I_{DM}	72	A
Gate-Source Voltage	V_{GS}	± 20	V
Power Dissipation	P_D	35	W
Single pulse avalanche energy (note2)	E_{AS}	90	mJ
Operating Junction and Storage Temperature Range	T_J, T_{stg}	-55 To 150	$^\circ C$

Thermal Resistance

Parameter	Symbol	Value	Unit
Thermal Resistance, Junction-to-Ambient	R_{thJA}	50	$^\circ C/W$
Maximum Junction-to-Case	R_{thJC}	3.6	$^\circ C/W$

Specifications $T_J = 25^\circ\text{C}$, unless otherwise noted						
Parameter	Symbol	Test Conditions	Value			Unit
			Min.	Typ.	Max.	
Static Parameters						
Drain-Source Breakdown Voltage	$V_{(BR)DSS}$	$V_{GS} = 0V, I_D = 250\mu A$	200	--	--	V
Zero Gate Voltage Drain Current	I_{DSS}	$V_{DS} = 200V, V_{GS} = 0V$	--	--	1	μA
Gate-Source Leakage	I_{GSS}	$V_{GS} = \pm 20V$	--	--	± 100	nA
Gate-Source Threshold Voltage	$V_{GS(th)}$	$V_{DS} = V_{GS}, I_D = 250\mu A$	1.0	1.5	3.0	V
Drain-Source On-Resistance	$R_{DS(on)}$	$V_{GS} = 10V, I_D = 9A$	--	123	190	m Ω
Forward Transconductance	g_{FS}	$V_{GS} = 5V, I_D = 9A$	--	8	--	S
Dynamic Parameters						
Input Capacitance	C_{iss}	$V_{GS} = 0V,$ $V_{DS} = 100V,$ $f = 1.0\text{MHz}$	--	852	--	pF
Output Capacitance	C_{oss}		--	73	--	
Reverse Transfer Capacitance	C_{rss}		--	15	--	
Total Gate Charge	Q_g	$V_{DD} = 100V,$ $I_D = 9A,$ $V_{GS} = 10V$	--	18	--	nC
Gate-Source Charge	Q_{gs}		--	4	--	
Gate-Drain Charge	Q_{gd}		--	5.3	--	
Turn-on Delay Time	$t_{d(on)}$	$V_{DD} = 100V,$ $I_D = 9A,$ $R_G = 5\Omega$	--	42	--	ns
Turn-on Rise Time	t_r		--	20.5	--	
Turn-off Delay Time	$t_{d(off)}$		--	125	--	
Turn-off Fall Time	t_f		--	6.5	--	
Drain-Source Body Diode Characteristics						
Continuous Body Diode Current	I_S	$T_C = 25^\circ\text{C}$	--	--	18	A
Body Diode Voltage	V_{SD}	$T_J = 25^\circ\text{C}, I_{SD} = 9A, V_{GS} = 0V$	--	--	1.2	V
Reverse Recovery Charge	Q_{rr}	$I_F = 9A, V_{GS} = 0V$ $di/dt = 100A/\mu s$	--	1066	--	nC
Reverse Recovery Time	T_{rr}		--	239	--	ns

Notes

1. Repetitive Rating: Pulse width limited by maximum junction temperature
2. EAS condition : $T_J = 25^\circ\text{C}, V_{DD} = 50V, V_{GS} = 10V, L = 0.5\text{mH}, R_G = 25\Omega$
3. Identical low side and high side switch with identical R_G

Gate Charge Test Circuit



Switch Time Test Circuit



EAS Test Circuit



Typical Characteristics $T_J = 25^\circ\text{C}$, unless otherwise noted

Figure 1. Output Characteristics

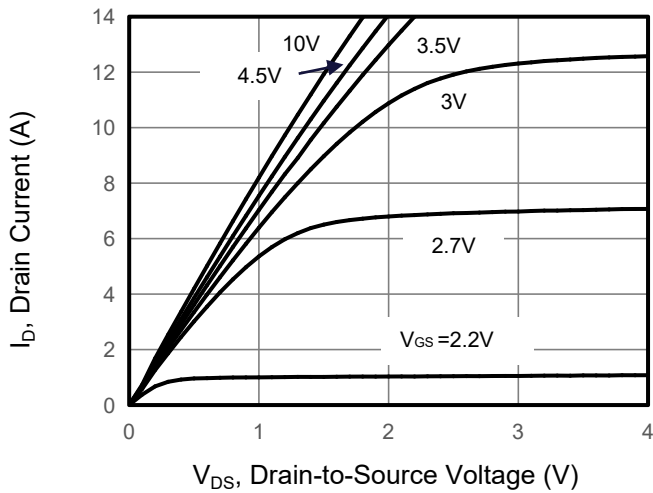

Figure 2. Transfer Characteristics

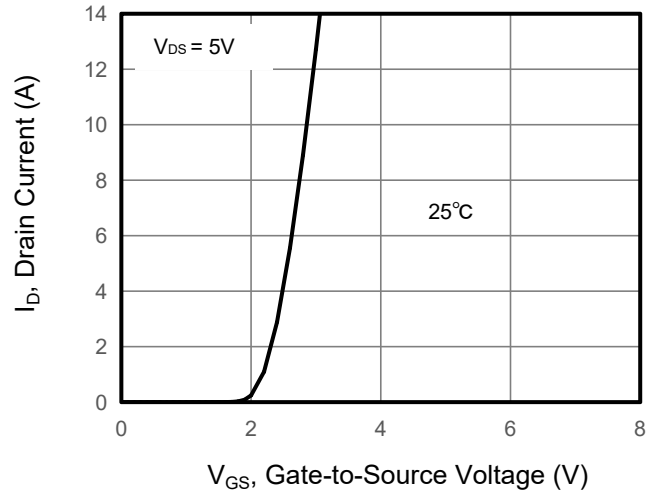

Figure 3. Drain Source On Resistance

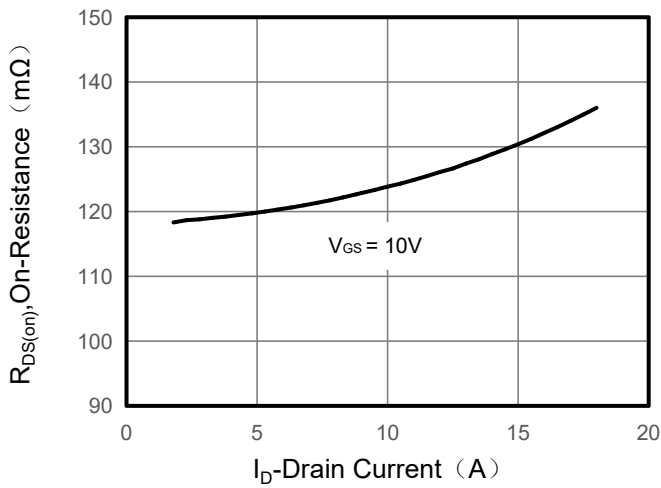

Figure 4. Gate Charge

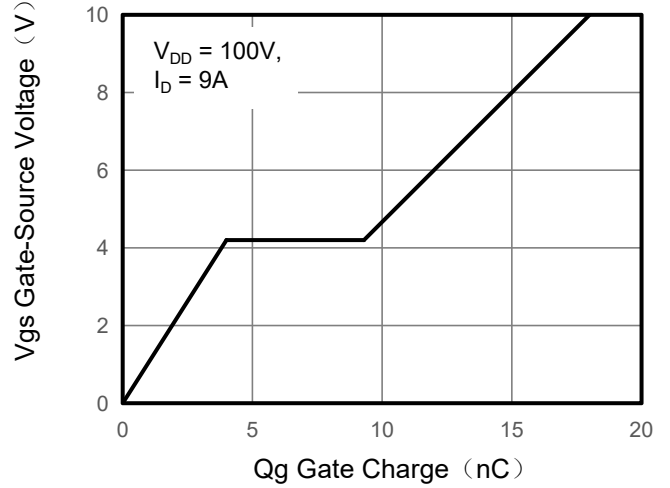

Figure 5. Capacitance

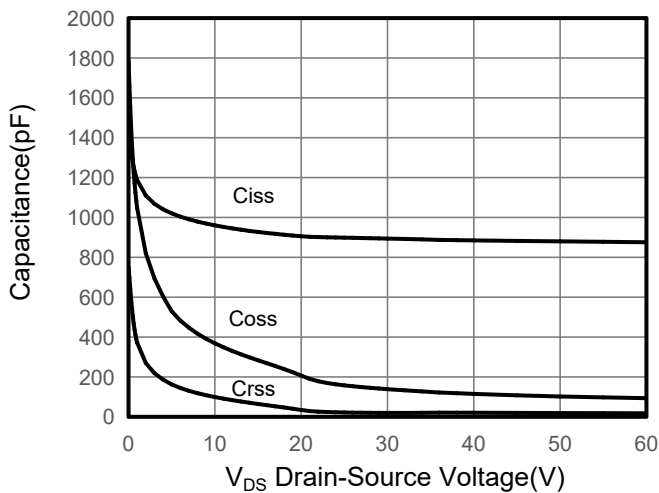
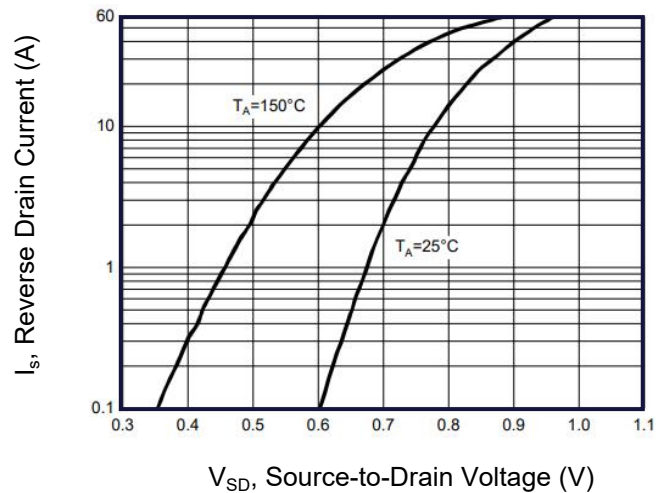

Figure 6. Source-Drain Diode Forward



Typical Characteristics $T_J = 25^\circ\text{C}$, unless otherwise noted

Figure 7. Drain-Source On-Resistance

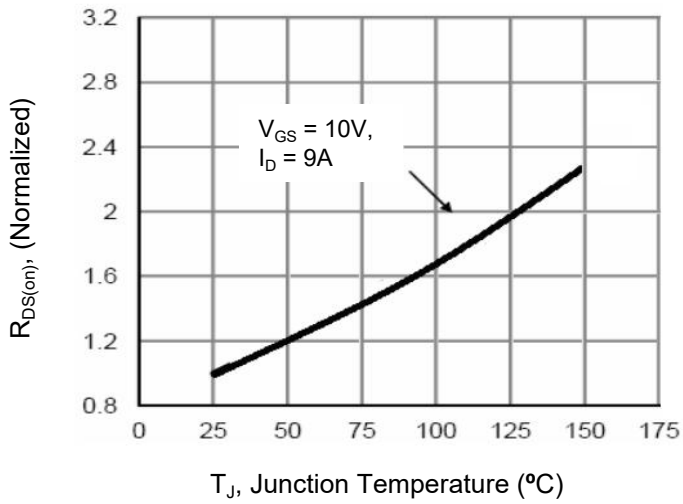

Figure 8. Safe Operation Area

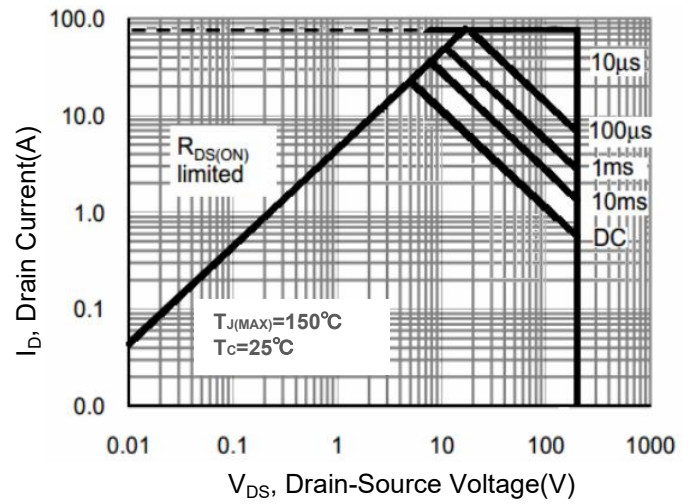
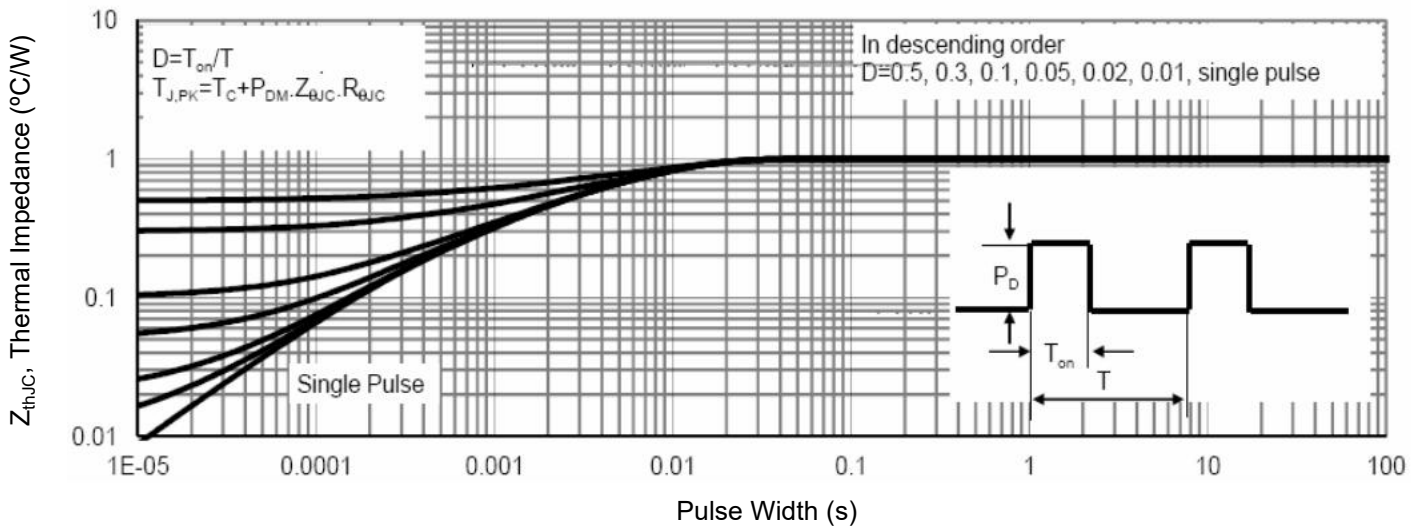
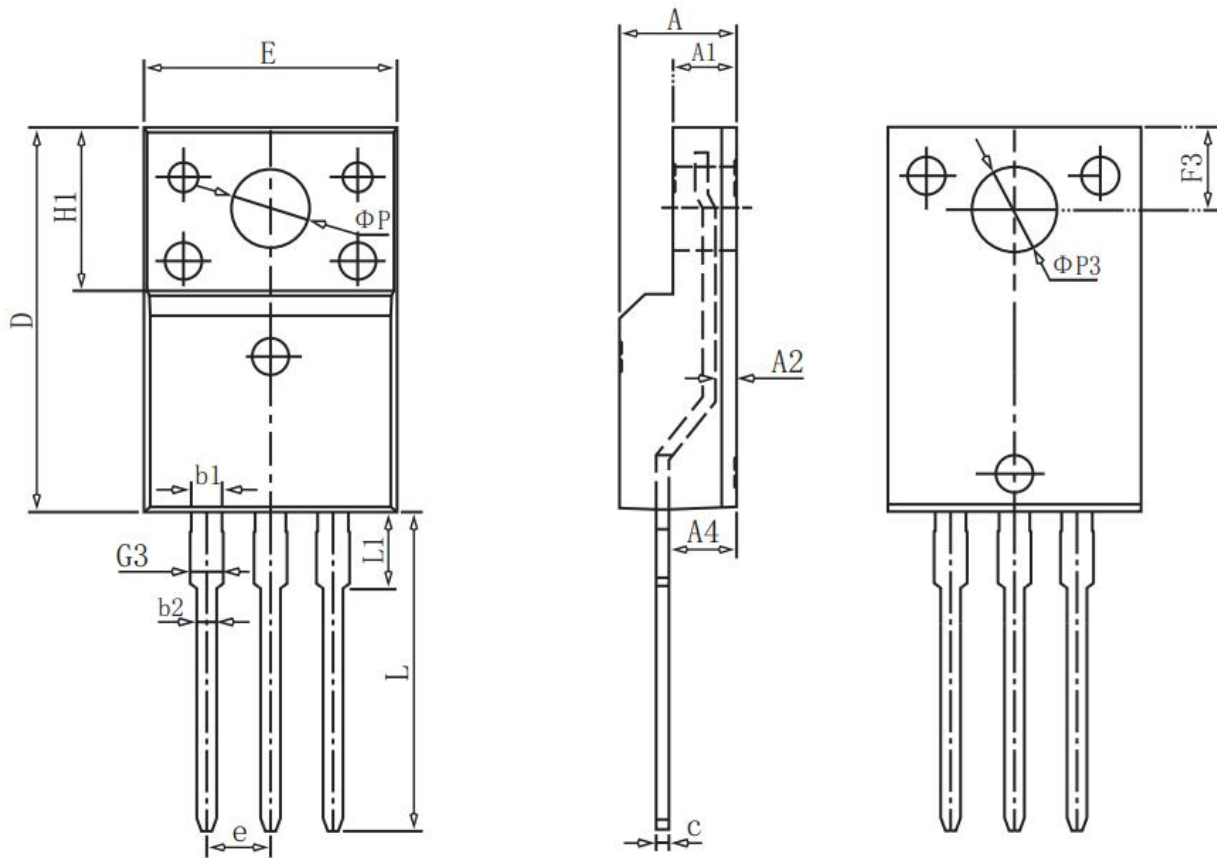

Figure 9. Normalized Maximum Transient Thermal Impedance



TO-220F Package Information



COMMON DIMENSIONS

SYMBOL	mm		
	MIN	NOM	MAX
E	10.00	10.20	10.40
A	4.50	4.70	4.90
A1	2.34	2.54	2.74
A2	0.65	0.85	1.30
A4	2.55	2.75	2.95
c	0.40	0.50	0.65
D	15.57	15.87	16.17
H1	6.70REF		
e	2.54BSC		
ΦP	3.183REF		
L	12.68	12.98	13.28
L_1	3.25	3.45	3.65
ΦP_3	3.45REF		
F3	3.10	3.30	3.50
G3	1.10	1.30	1.50
b_1	1.05	1.20	1.35
b_2	0.70	0.80	0.92