

# Specification Approval Sheet

## 产品规格书

Battery Type: GRP604543-1C-1S1P-3.7V-1050mAh

电池型号: GRP604543-1C-1S1P-3.7V-1050mAh

Customer Code (客户代码) : 63700

Supplier 供应商	Prepared By 编制	Guo jianhui	2021-04-27
	Checked By (RD) 审核 (研发)	Wu shengdon	2021-04-27
	Checked By (QC) 审核 (品质)		
	Approved By 批准		
Customer Approval (客户批准)	Company Name(公司名称)		
	Signature/Date(签名/日期)		
	Company Stamp(公司印章)		

Amendment Records

(修正记录)

Edition (版本)	Description (记述)	Prepared by (编制)	Checked (审核)	Date (日期)
A	First Publish (首次编写)	Guo jianhui	Wu shengdon	2021-04-27

Appendix

**附**

**Customer's Checking Criterion**

(customer required)

**客户验收标准 (客户必填) :**

- By Grepow's Testing Criterion for Lithium Polymer Battery。

按格瑞普电池有限公司电池检验标准

- By Customer's Testing Request and Criterion (Customer must supply the checking criterion)

按客户要求检验 (需附验货标准)

## Content

## 目录

1.Scope 适用范围 .....	5
2. Specification 产品规格.....	5
2.1 Cell specification 单电芯规格 .....	5
2.2 Package specification 电池组规格 .....	6
3. Protection Circuit Characteristics 保护电路特性.....	7
3.1 Electrical Characteristic 电气性能.....	7
3.2 PCB Wiring diagram 保护板布线图.....	7
3.3 Schematic circuit diagram 电路原理图.....	8
3.4 Parts List 物料清单 .....	8
4. Code-spurting(Label) Content 喷码 (标贴) 内容.....	8
5. Pack Drawing 组装示意图 .....	9
6. Package Schemes 包装示意 .....	9
7.1 Standard Test Condition 标准测试条件.....	10
7.2 Visual inspection 外观检查.....	10
7.3 Measuring Instrument or Apparatus 测量器具及设备 .....	10
7.4 Routine Inspection And Battery Performance Testing.....	11
常规性能检查及测试	
7.5 Safety Test 安全性能测试.....	12
7.6 Environmental and mechanical Character.....	13
环境及机械性能测试	
Handling Precautions and Guideline .....	15
聚合物锂离子充电电池操作指示及注意事项	
1.Charging 充电.....	15
2.Discharging 放电 .....	16
3.Storage 贮存 .....	17
4.Handling of Cells 电池操作注意事项.....	17
5.Notice for Designing Battery Pack 电池外壳设计注意事项 .....	18
6.Noticefor Assembling Battery Pack 电池与外壳组装注意事项.....	18
7.Others 其它事项 .....	18

1. Scope 适用范围

This document describes the Product Specification of the Lithium-Polymer (LIP) rechargeable battery pack supplied by Grepow Battery Corporation Limited.

本规格说明书描述了深圳市格瑞普电池有限公司生产的可充电聚合物锂离子电池的产品性能指标

2. Specification 产品规格

2.1 Cell specification 单电芯规格

Cell (电芯)	NO	Items	Specifications	
	1	Nominal capacity 标称容量	1050mAh@ 0.2C Discharge end voltage 3.0V (0.2C 放电至 3.0V) 允许循环 3 次 Up to 3 cycles are allowed	
	2	Minimum capacity 最低容量	1000mAh @ 0.2C Discharge end voltage 3.0V (0.2C 放电至 3.0V) 允许循环 3 次 Up to 3 cycles are allowed	
	3	Nominal voltage 标称电压	3.7V	
	4	AC Internal Impedance 交流内阻	≤40mΩ(SOC 40-50%) (ref.)	
	5	Dimension 尺寸	Thickness/厚度: Max 6.0mm(Shipment) ; Max 6.48mm(Swelling)	
			Width/宽度: Max 45mm	
			Length/长度: Max 42.7mm	
			极耳中心间距: 11±1mm Distance between middle of 2 tabs: 11±1mm	
			极耳宽度: 3±0.2mm Tab width: 3±0.2mm	
6	Cell weight 单电芯重量	20.0±1.0g		
7	Standard charge 标准充电	0.5C CC (constant current) charge to 4.2V, then CV (constant voltage 4.2V) charge till charge current decline to ≤0.05C 0.5C CC (恒流) 充电至 4.2V, 再 CV (恒压 4.2V) 充电直至充电电流 ≤0.05C		
8	Charging time 充电时间	Standard Charging: 3 hours (Ref.) Rapid charge : 1.5 hours (Ref.) 标准充电: 3 小时 (参考值) 快速充电: 1.5 小时 (参考值)		
9	Standard discharge 标准放电	Constant current 0.5C end voltage 3.0V (持续电流: 0.5C 截止电压: 3.0V)		
10	Maximum discharge current 最大放电电流	Constant max current 1C end voltage 3.0V (持续最大放电电流 1C 截止电压: 3.0V)		

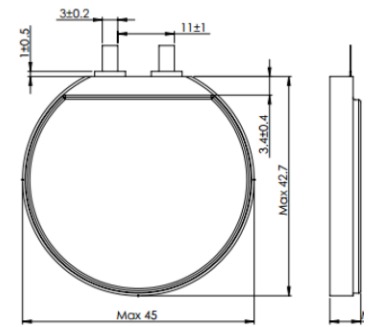

		最大放电电流	
11	Operating temperature 工作温度	Charging (充电) : 10℃~45℃ (Max 1C) Discharging (放电) : -20℃~60℃	
12	Storage temperature 储存温度	-20℃~ 35℃	

2.2 Package specification 电池组规格

NO	Items	Specifications
1	Combination method (组合方式)	1 _ S _ 1 _ P (一串一并)
2	Nominal capacity 标称容量	1050mAh @ 0.2C Discharge(放电)
3	Minimum capacity 最小容量	1000mAh @ 0.2C Discharge(放电)
4	Nominal voltage 标称电压	3.7V
5	PACK Voltage(As of shipment) 电池电压(出货状态)	3.75~3.90V (cell 3.75~3.90V)
6	AC Internal Impedance (交流内阻)	≤140mΩ (SOC 40-50%)(ref.)
7	Dimensions (尺寸)	MAX (T*W*H) : 6.15*45.1*45mm(As of shipment) ; 6.63*45.1*45.0mm(After swelling)
8	Pack weight (电池重量)	20.2±1.5g
9	Standard Charge 标准充电	0.5C CC (constant current) charge to 4.2V, then CV(constant voltage 4.2V) charge till charge current decline to ≤0.05C 0.5C CC (恒流) 充电至 4.2V, 再 CV (恒压 4.2V) 充电直至充电电流≤0.05C
10	Rapid Charge 快速充电	Constant Current 1.0C, Constant Voltage 4.2V, 0.05C cut-off 持续电流: 1.0C 持续电压: 4.2V 截止电流: 0.05C
11	Charging time 充电时间	Standard Charging : 3.0hours(Ref.) 标准充电: 3.0 小时 (参考值) Rapid charge : 1.5 hours(Ref.) 快速充电: 1.5 小时 (参考值)
12	Standard discharge (标准放电)	Constant current 0.5C end voltage 3.0V (持续电流: 0.5C 截止电压: 3.0V)
13	Max discharge current 最大放电持续电流	Constant current 1.0C end voltage 3.0 V (持续电流 1.0C 截止电压: 3.0 V)
14	Charge upper limit voltage 充电上限电压	It's same to over charge detection voltage 与过充电检测电压相同
15	Discharge lower limit voltage 放电下限电压	It's same to Over discharge detection voltage 与过放电检测电压相同

注: If no otherwise specified, an interval rest time is 30min between charging and discharging.

如果没有特别说明, 电池充放电间隔时间为 30 分钟。

### 3. Protection Circuit Characteristics (at 25°C)保护电路特性

#### 3.1 Electrical Characteristic 电性能特性

Item 项目	Content 内容	Criterion 标准
Over charge Protection 过充保护	Over charge detection voltage 过充电检测电压	4.28±0.025V (cell) (delay time 延时: 1.2S)
	Over charge release voltage 过充电解除电压	4.13±0.05V
Over discharge protection 过放保护	Over discharge detection voltage 过放电检测电压	2.8±0.05V (cell) (delay time 延时: 180mS)
	Over discharge release voltage 过放电解除电压	3.1±0.1V
Over current protection 过流保护	Over current detection current 过流检测电流	3-8A (delay time 延时: 7.2-11ms)
	Release condition 解除条件	Cut load 开路负载
Short protection 短路保护	Detection condition 检测条件	Exterior short circuit 外部电路短路 (delay time 延时: 240-360uS)
	Release condition 解除条件	Cut short circuit 断开短路电路
Continue current 持续电流	Continuous output discharging current 可持续工作电流	≤1.5A
Interior resistance 内阻	Main loop electrify resistance (VC=3.8V) 主回路通态电阻 (电池电压=3.8V)	B-至 CH- R <sub>DS</sub> ≤65mΩ
Current consumption 电流消耗	Normal mode 正常模式	≤5.5μA

#### 3.2 PCB Pad description 焊盘描述

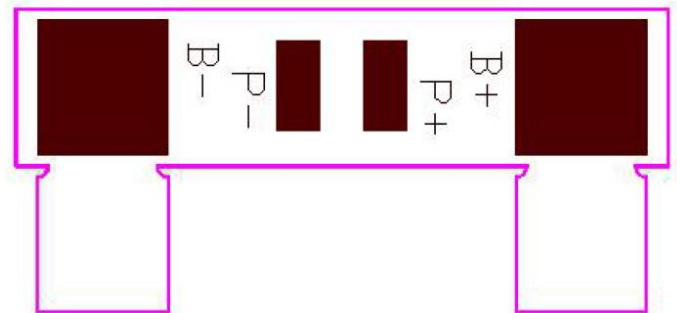
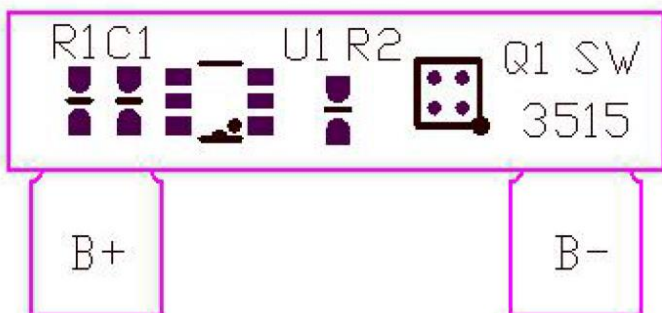

3.3 Schematic circuit diagram 电路原理图

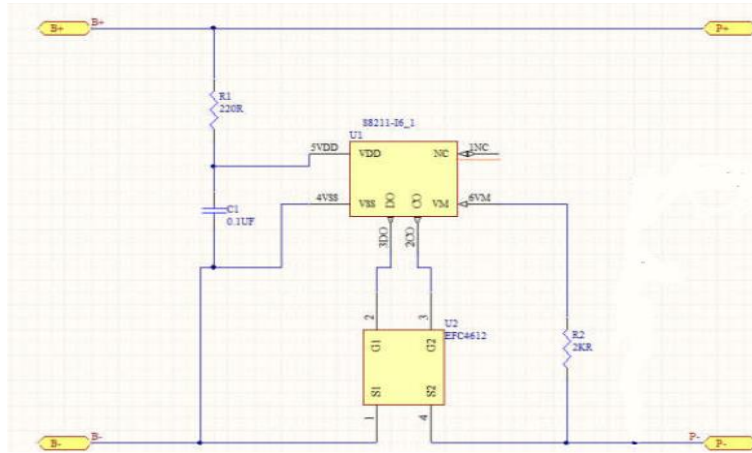

3.4 Parts List 物料清单

序号 NO.	物料名称 Description	代号 Symbol	规格/型号 Spec./Model	尺寸/封装 Size	数量 Q'ty	单位 unit	供应商 Vendor	备注
1	Protection IC	U1	S-8211CAS-I6T1U,单节保护IC,SNT-6A,无卤,ABLIC	SNT-6A	1	pcs	ABLIC	丝印 RZSx
2	MOSFET	Q1	MOSFET, FC4B22070L/EFC4, HF	EFC4	1	pcs	Panasonic	丝印 14x xxx
3	贴片电阻 SMD Resistance	R1	RC0402JR-07220RL,0402,220Ω,±5%,1/16W,HF,YAGEO	0402	1	pcs	YAGEO	
4	贴片电阻 SMD Resistance	R2	RC0402JR-072KL,0402,2KΩ,±5%,1/16W,HF,YAGEO	0402	1	pcs	YAGEO	
5	贴片电容 SMD Capacitance	C1	CC0402KRX7R7BB104,0402,0.1uf,±10%,X7R,16V,无卤素,YAGEO	0402	1	pcs	YAGEO	
6	贴片电容 SMD Capacitance	C1	GRM155R61E104KA87D/0402/X5R/0.1UF/25V/±10%/HF/MURATA	0402	1	pcs	MURATA	备选
7	PCB	PCB	SW-3515LC-002-V0,15.0*3.5*0.6mm,FR4,双层,OSP,黑油, RoHS	/	1	pcs	JHY	

4. Code-spurting(Label) Content 喷码 (标贴) 内容

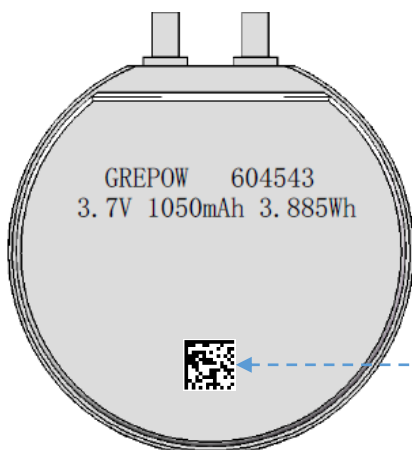

Format of serial number is CC03J10001 (共 10 码)		
Note	Item	Definition
Digit 1	C	Build year, form A=2015,B=2016, ...
Digit 2	C	Build month, form A=1,B=2, ...
Digit 3-4	03	Build day
Digit 5	J	Planned serial number
Digit 6	1	Production line no.
Digit 7-10	0001	Unique battery SN



5. Pack Drawing 组装示意图

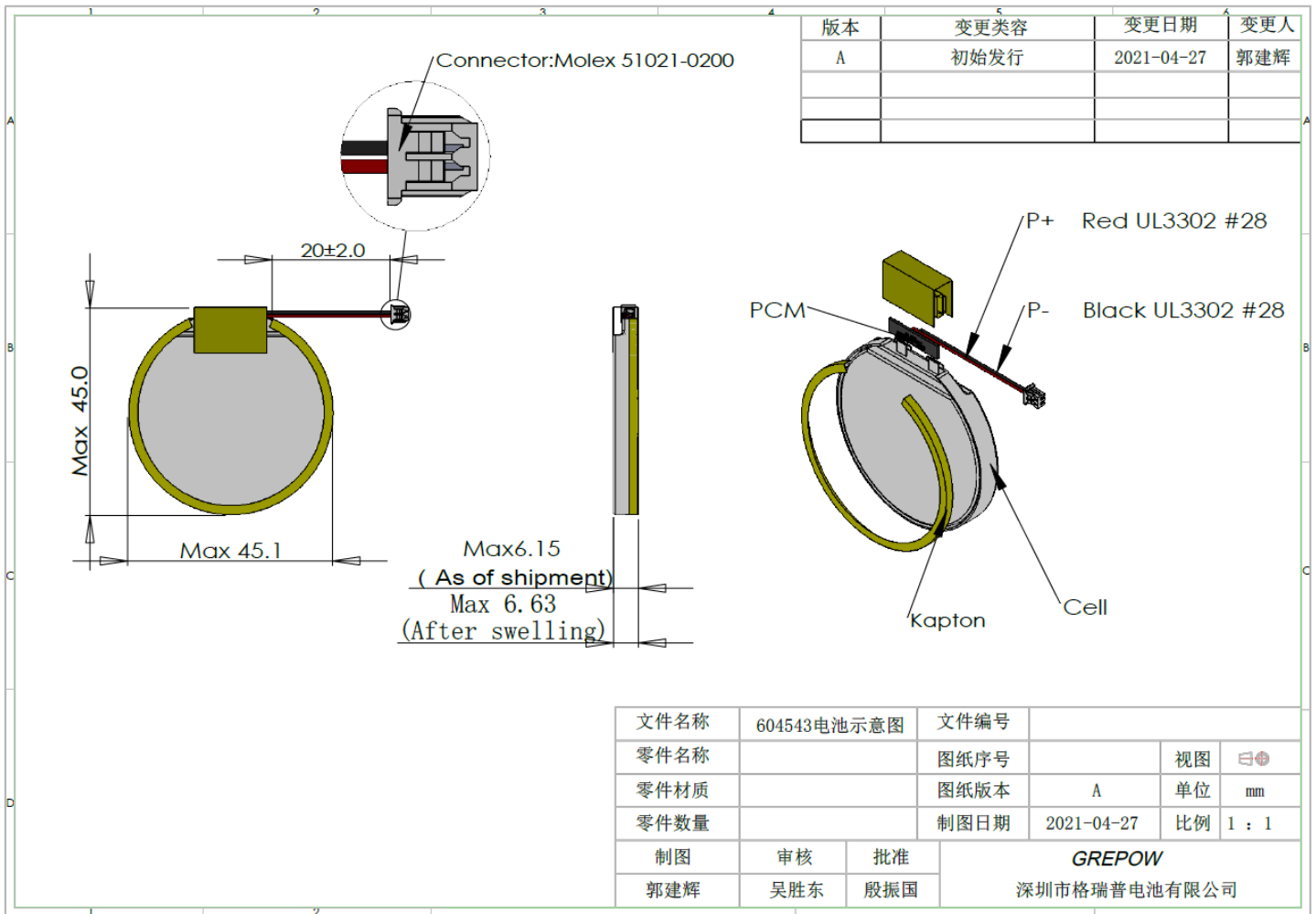

6. Package Schemes 包装示意

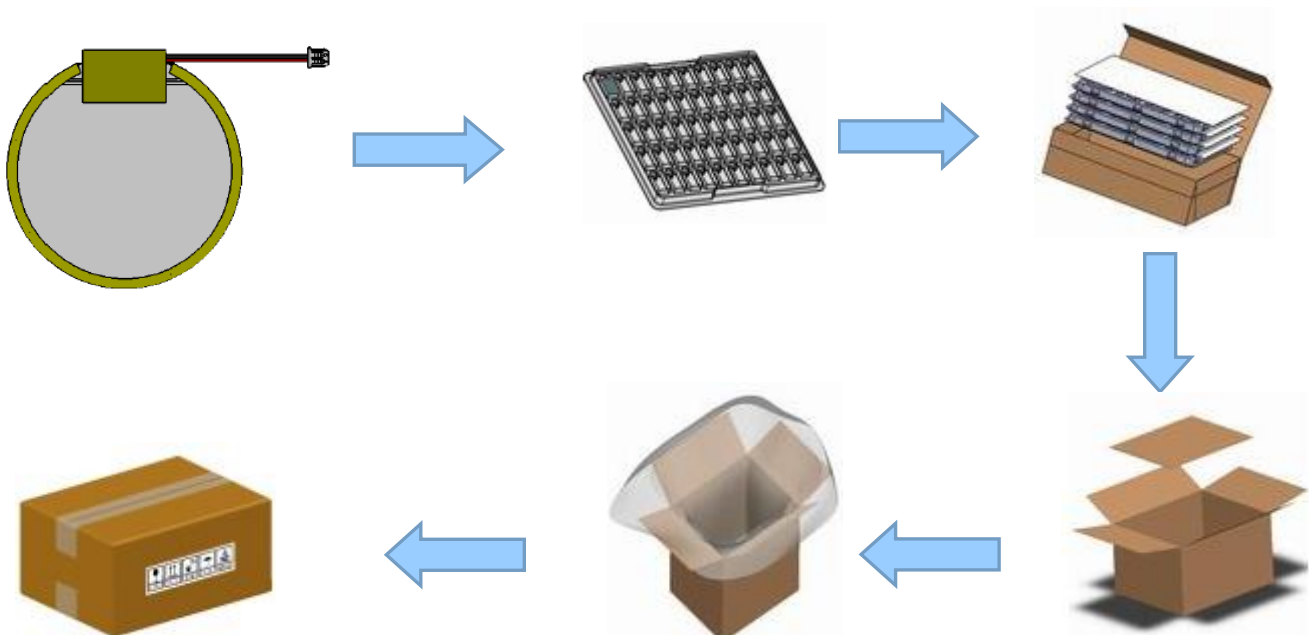

## 7. Performance And Test Conditions(电池性能测试条件)

### 7.1 Standard test condition (标准测试条件)

Before proceed the following tests, the cells should be discharged at 0.5C to 3.0V cutoff. Unless otherwise stated, tests should be done within one month of delivery under the following conditions:

Ambient temperature:  $23^{\circ}\text{C}\pm 2^{\circ}\text{C}$       Relative Humidity:  $\leq 75\%$

Note Standard Charge/Discharge Conditions:

Charge: The battery will be charged with 0.5C constant current to 4.2V then constant voltage 4.2 V till cut-off current $<0.05\text{C}$ ;

Discharge: 0.5C to 3.0V/cell

在进行下列各项测试前每颗电池应用 0.5C 放至 3.0V。如果没有特别规定，测试应在电池交付 1 个月内按以下各项条件进行：

环境温度： $23^{\circ}\text{C}\pm 2^{\circ}\text{C}$       相对湿度： $\leq 75\%$

注意标准充放电为：

充电：以 0.5C 电流恒流充电至限制电压 4.2V 时,改为恒压充电,直到截止电流为 0.05C 时停止充电;

放电：以 0.5C 电流恒流放电至限制电压 3.0V

### 7.2 Visual inspection (外观检查)

There shall be no such defect as scratch, flaw, crack, and leakage, which may adversely affect commercial value of the cell..

不允许有任何影响电池性能的外观缺陷，诸如裂纹、裂缝、泄漏等。

### 7.3 Measuring Instrument or Apparatus (测量器具及设备)

#### 7.3.1 Dimension Measuring Instrument (尺寸测量器具)

The dimension measurement shall be implemented by instruments with equal or more precision scale of 0.01mm.

尺寸测量器具的精度等级应不小于 0.01 mm 。

#### 7.3.2 Voltmeter (伏特计)

Standard class specified in the national standard or more sensitive class having inner impedance more than  $10\text{k}\Omega/\text{V}$

按照国家标准指定规格等级或采用灵敏度更高的，测量电压时内阻不应小于  $10\text{k}\Omega/\text{V}$ 。

#### 7.3.3 Ammeter (安培计)

Standard class specified in the national standard or more sensitive class. Total external resistance including ammeter and wire is less than  $0.01\Omega$ .

按照国家标准指定规格等级或采用灵敏度更高的，包括电流表及电线在内的总外阻应小于  $0.01\Omega$ 。

#### 7.3.4 Impedance Meter (电阻计)

Impedance shall be measured by a sinusoidal alternating current method (1kHz LCR meter).

内阻测试仪测量原理应为交流阻抗法 (1kHz LCR) 。

## 7.4 Routine Inspection And Testing Of Battery Performance 电池常规性能检查及测试

1	Discharge Performance at different temperature 不同温度下放电特性	High Temperature : Storage 2hrs at 60±2℃ after standard charge,0.5C discharge at 60±2℃ 高温: 标准充电后储存在 60±2℃的环境中, 2 小时后用 0.5C 放电	≥95%	
		Normal Temperature : Standard Charge / Discharge 常温: 标准充放电	100%	
		Low Temperature : Storage 2hrs at -20±2℃ after standard charge,0.2C discharge at -20±2℃ 低温: 标准充电后储存在-20±2℃的环境中, 2 小时后用 0.2C 放电	≥70%	
2	Cycle Life 循环寿命	<p>Test condition :</p> <p>Step1 : Charge: 0.5C to 4.2V , end current 0.05C</p> <p>Step2 : Rest :10min</p> <p>Step3 : Discharge: 0.5C to 3.0V</p> <p>Step4 : Rest : 10min</p> <p>Step5 : cycle from step1 to step 4</p> <p>More than 80% first capacity at 0.5C discharging</p> <p>测试条件:</p> <p>1) 恒流恒压充电: 0.5C充电到4.2V 限流 0.05C</p> <p>2) 静置: 10min</p> <p>3) 恒流放电: 0.5C放电到3.0V</p> <p>4) 静置: 10min</p> <p>5) 循环 1) 至4) 工步</p> <p>当以0.5C放电容量小于初始容量80%时, 所完成的循环次数定义为该电芯的循环寿命</p>	≥500 cycles	
3	Charge retention 电保持	23 ℃ for 28days 常温 28天	<p>Standard charge, storage : 28days at 23±2℃</p> <p>0.5C discharge at 23±2℃to test residual capacity</p> <p>标准充满电后 23 度贮藏 28 天。</p> <p>然后常温下 0.5C 放电, 所得容量为剩余容量</p>	Residual capacity ≥ 85% (First Capacity) 剩余容量≥85% 初始容量
			<p>Standard charge/discharge for 3 cycles, to test recovery capacity</p> <p>按标准充放电制式循环 3 次, 取最大值为恢复容量</p>	Recovery Capacity ≥ 95% (First Capacity) 恢复容量≥95% 初始容量
		60℃ 4 小时 60℃ 4hrs	<p>Standard charge, storage:4hrs at 60±2℃</p> <p>0.5C discharge at 23±2℃to test residual capacity</p> <p>标准充电后贮藏在 60±2℃环境中 4 小时然后常温下 0.5C 放电, 所得容量为剩余容量</p>	Residual capacity ≥ 95% (First Capacity) 剩余容量≥95%

			Standard charge/discharge for 3 cycles, to test recovery capacity 按标准充放电制式循环 3 次, 取最大值为恢复容量	初始容量 Recovery Capacity ≥ 95% (First Capacity) 恢复容量 ≥ 95% 初始容量
--	--	--	--	---

7.5 Safety Test 安全性能测试

NO	Test Items	Test Method and Condition	Criteria
1	Short Circuit (短路试验 20℃)	Fully charge cell is to be short-circuit by connecting The positive and negative terminals with a circuit load having a resistance of $80 \pm 20 \text{ m}\Omega$ at $20 \pm 5^\circ\text{C}$ .The cell is to discharge until it has reached a completely discharged stated less than 0.2V, and the cells case temperature has returned to $10^\circ\text{C}$ ambient temperature. 完全充电后, 电芯应在电阻 $80 \pm 20 \text{ m}\Omega$ 的导体条件下, 在室温环境下进行短路试验, 当电芯端电压低于0.2V, 同时电芯外壳温度恢复至不高于初始环境温度 $10^\circ\text{C}$ 时, 结束试验	No explosion, No fire The Temperature of the surface of the Cells are lower than $150^\circ\text{C}$ (无起火无爆炸, 电池表面温度应低于 $150^\circ\text{C}$ )
2	Short Circuit (短路试验 $55^\circ\text{C}$ )	Fully charge cell is to be short-circuit by connecting The positive and negative terminals with a circuit load having a resistance of $80 \pm 20 \text{ m}\Omega$ at $55 \pm 5^\circ\text{C}$ .The cell is to discharge until it has reached a completely discharged stated less than 0.2V, and the cells case temperature has returned to $10^\circ\text{C}$ ambient temperature. 完全充电后, 电芯应在电阻 $80 \pm 20 \text{ m}\Omega$ 的导体条件下, 在 $55 \pm 5^\circ\text{C}$ 环境下进行短路试验, 当电芯端电压低于0.2 V, 同时电芯外壳温度恢复至不高于初始环境温度 $10^\circ\text{C}$ 时, 结束试验	No explosion, No fire The Temperature of the surface of the Cells are lower than $150^\circ\text{C}$ (无起火无爆炸, 电池表面温度应低于 $150^\circ\text{C}$ )
3	Forced discharge (强制放电)	Battery discharge at 0.2C current with standard environment. After discharge to cut off voltage, battery connect with thermocouple and place in ventilation system. Then charge the battery up to 5V, charging current at 1C, room temperature. Charging time must over 90mins 标准环境下电池以0.2C放完电, 然后接热电偶置于通风设备中, 室温下以1C电流对电池进行反向充电到5V, 充电时间不低于90min	No fire, No explosion (无起火无爆炸)

4	Thermal Shock Test 热冲击	<p>In standard test environment, charge the battery fully, then put into oven, connect to the thermocouple (fixed at the central of the battery surface). Keep the temperature in the oven rising with a speed of <math>5\pm 2^{\circ}\text{C}/\text{min}</math> till <math>130\pm 2^{\circ}\text{C}</math>, then keep it at this level for 30 min.</p> <p>标准测试环境下将电池充满电, 将电池放于热箱中, 然后接热电偶 (固定在电池表面中心位置), 温度以<math>5\pm 2^{\circ}\text{C}/\text{min}</math>的速率升至<math>130\pm 2^{\circ}\text{C}</math>并保温30min</p>	<p>No fire and no explosion 不着火不爆炸</p>
5	Crush test 挤压	<p>Fully charged, the cell is to be crushed in a maximum surface. The force for the crushing is to be applied by a hydraulic ram with 32mm diameter piston. The crushing is to be continued until a pressure of 13 kN. Once the maximum pressure has been obtained it is to be released.</p> <p>完全充电后, 电芯在最大面上承受一次挤压, 挤压的压力由一个直径为32mm活塞的液压油缸提供, 挤压将一直持续到压力为13 kN, 一旦这个最大压力达到马上卸压; 然后搁置4h以上</p>	<p>No fire and no explosion 不着火不爆炸</p>

7.6 Ambient and Mechanical Character 环境及机械性能测试

NO	Test Items	Test Method and Condition	Criteria
1	Constant temperature and humidity 恒定湿热性能	<p>Fully charged, the cell is to be placed in a chamber with a constant <math>40\pm 2^{\circ}\text{C}</math>, 90%~95% relative humidity for 48hrs. Then 0.2C discharge to turn-off voltage.</p> <p>完全充电后, 将电芯放入<math>40\pm 2^{\circ}\text{C}</math>, 相对湿度为90%~95%的恒温恒湿箱中搁置48h, 取出电池常温搁置2h, 再以0.2C放电至截止电压</p>	<p>No deformation ,no fire, no explosion and leakage 不变形、起火、爆炸、漏液 Discharge time <math>\geq</math> 3hrs, 放电时间<math>\geq</math> 3小时</p>
2	Temperature cycling test 温度循环	<p>Fully charge cells are to be placed in a test chamber and subjected to the following cycles:</p> <ol style="list-style-type: none"> <li>Raising the chamber temperature to <math>75\pm 2^{\circ}\text{C}</math> and maintaining this temperature for 6hrs</li> <li>Raising the chamber temperature to <math>-40\pm 2^{\circ}\text{C}</math> and maintaining this temperature for 6hrs</li> <li>Raising the chamber temperature must be within 30 min</li> <li>repeated step 1-2 for 10 cycles</li> </ol> <p>充满电的电芯放于测试箱内并承受以下循环:</p> <ol style="list-style-type: none"> <li>箱内升温至 <math>75\pm 2^{\circ}\text{C}</math>, 保温 6h。</li> <li>箱内降温至<math>-40\pm 2^{\circ}\text{C}</math>, 保温 6h。</li> <li>温升时间控制在 30min 内。</li> <li>重复 1-2 步骤 10 周</li> </ol>	<p>No fire , no explosion and leakage 不起火, 不爆炸不漏液</p>

3	Altitude simulation Test 高空模拟	Fully charged, the cells are to be stored for 6 hours at an absolute pressure of 11.6 kPa and a room temperature 完全充满电后, 电池在绝对压力为11.6Kpa、室温条件下放置6小时	No fire, no explosion and no leakage 不爆炸, 不起火、漏液
4	Vibration Test 振动测试	After standard charge, fixed the cell to vibration table and subjected to vibration cycling that the frequency is to be varied at the rate of 1Hz per minute between 10Hz~ 55Hz, the excursion of the vibration is 1.6mm.The cell shall be vibrated for 30 minutes per axis of XYZ axes. 将标准充电后的电芯固定在振动台上, 沿 X、Y、Z 三个方向各振动 30 分钟, 振幅 1.6 mm, 振动频率为 10Hz~55Hz, 每分钟变化为 1Hz。	No fire, no explosion and no leakage residual capacity ≥ 80% First capacity, the Voltage ≥ 90% initial voltage, Impedance<1.5 initial Impedance 不爆炸、不起火、不漏液, 剩余容量≥ 80 % 初始容量、测试后电压 ≥ 90 % 初始开路电压、测试后内阻增加≤1.5 倍初始内阻
5	Drop test 自由跌落	After standard charge, the battery is dropping to the wood board with a thickness of 18mm to 20mm on the cement ground, the height shall be 1m measured from the lowest point of the battery to the wood board surface. Drop the cell from X, Y, Z direction (including face side and reverse side direction each) each time, then measured the capacity at a discharge current 0.5C and a cut-off voltage of 3.0V., and then cycled times to measure the maximal discharge capacity. 将标准充电后的电芯从 1m 高度 (最低点高度) 位置自由跌落到置于水泥地面上的 18~20 mm厚的硬木板上, 从 X、Y、Z 正负方向 (六个方向) 每个方向自由跌落 1 次; 结束后将电池以(0.5C)电流放电至 3.0V 测试放电容量。	No fire, no explosion and no leakage, Residual capacity ≥95% First capacity 不爆炸、不起火、不漏液, 放电容量≥ 90 % 初始容量

Appendix

附录

Handling Precautions and Guideline

For LIP(Lithium-Ion Polymer)Rechargeable Batteries

聚合物锂离子充电电池操作指示及注意事项

Preface

This document of Handling Precautions and Guideline for LIP Rechargeable Batteries shall be applied to the battery cells manufactured by GREPOW.

前言

本文件“聚合物锂离子充电电池操作指示及注意事项”仅适用于深圳市格瑞普电池有限公司生产的电池。

Note(1):

The customer is requested to contact GREPOW in advance, if and when the customer needs other applications or operating conditions than those described in this document. Additional experimentation may be required to verify performance and safety under such conditions.

声明一:

客户若需要将电池用于超出文件规定以外的设备，或在文件规定以外的使用条件下使用电池，应事先联系格瑞普，因为需要进行特定的实验测试以核实电池在该使用条件下的性能及安全性。

Note(2):

GREPOW will take no responsibility for any accident when the cell is used under other conditions than those described in this Document.

声明二:

对于在超出文件规定以外的条件下使用电池而造成的任何意外事故，格瑞普概不负责。

Note(3):

GREPOW will inform, in a written form, the customer of improvement(s) regarding proper use and handing of the cell, if it is deemed necessary.

声明三:

如有必要，格瑞普会以书面形式告之客户有关正确操作使用电池的改进措施。

1. Charging 充电

1.1 Charging current 充电电流:

Charging current should be less than maximum charge current specified in the Product Specification. Charging with higher current than recommended value may cause damage to cell electrical, mechanical and safety performance and could lead to heat generation or leakage.

充电电流不得超过本标准书中规定的最大充电电流。使用高于推荐值电流充电将可能引起电池的充放电性能、机械性能和安全性能的问题，并可能会导致发热或泄漏。

1.2 Charging voltage 充电电压:

Charging shall be done by voltage less than that specified in the Product Specification 4.2V. Charging beyond 4.25V, which is the absolute maximum voltage, must be strictly prohibited. The charger shall be designed to comply with this condition.

It is very dangerous that charging with higher voltage than maximum voltage may cause damage to the cell electrical, mechanical safety performance and could lead to heat generation or leakage.

充电电压不得超过本标准书中规定的额定电压 4.2V。4.25V 为充电电压最高极限，充电器设计应满足此条件。

电芯电压高于额定电压值时，将可能引起电池的充放电性能、机械性能和安全性能的问题，可能会导致发热或泄漏。

### 1.3 Charging temperature 充电温度:

The battery shall be charged within 10°C~45°C range in the Product Specification.

电池必须在 10°C~45°C 的环境温度范围内进行充电。

### 1.4 Prohibition of reverse charging 禁止反向充电:

Reverse charging is prohibited. The battery shall be connected correctly. The polarity has to be confirmed before wiring, In case of the battery is connected improperly, the battery cannot be charged. Simultaneously, the reverse charging may cause damaging to the battery which may lead to degradation of battery performance and damage the battery safety, and could cause heat generation or leakage.

正确连接电池的正负极，严禁反向充电。若电池正负极接反，将无法对电池进行充电。同时，反向充电会降低电池的充放电性能、安全性，并会导致发热、泄漏。

## 2. Discharging 放电

### 2.1 Discharging current 放电电流

The battery shall be discharged at less than the maximum discharge current specified in the Product Specification.

High discharging current may reduce the discharging capacity significantly or cause over-heat.

放电电流不得超过本标准书规定的最大放电电流，大电流放电会导致电池容量剧减并导致过热。

### 2.2 Discharging temperature 放电温度

The battery discharge temperature is -20~60°C, 5~45°C environment suggested when Discharge with large current, small current discharge suggested under <5°C or >45°C, Discharged under too low or too high temperature could lead to battery failure or other conditions.

电池放电环境温度为-20~60°C。大电流放电建议在 5~45°C 环境下进行，<5°C 或 >45°C 建议用小电流进行放电，过低或过高温度大电流放电将可能导致电池失效或出现其他状况。

### 2.3 Over-discharging 过放电:

It should be noted that the battery would be at over-discharged state by its self-discharge characteristics in case the cell is not used for long time. In order to prevent over-discharging, the battery shall be charged periodically to maintain between 3.6V and 3.9V.

Over-discharging may causes loss of cell performance, characteristics, or battery functions.

The charger shall be equipped with a device to prevent further discharging exceeding a cut-off voyage specified in the Product Specification. Also the charger shall be equipped with a device to control the recharging procedures as follows:

The battery pack shall start with a low current (0.01C) for 15-30 minutes, i.e.-charging, before rapid charging starts. The rapid charging shall be started after the (individual) cell voltage has been reached above 3.6V within 15-30 minutes that can be determined with the use of an appropriate timer for pre-charging. In case the (individual) cell voltage does not rise to 3.0V within the pre-charging time, then the charger shall have functions to stop further charging and display the cell/pack is at abnormal state.



需要注意的是, 在电池长期未使用期间, 它可能会用其它自放电特性而处于某种过放电状态。为防止放电的发生, 电池应定期充电, 将其电压维持在 3.6V 至 3.9V 之间。

过放电会导致电池性能、电池功能的丧失。

充电器应有装置来防止电池放电至低于本标准书规定的截止电压。此外, 充电器还应有装置以防止重复充电, 步骤如下:

电池在快速充电之前, 应先以一小电流 (0.01C) 预充电 15~30 分钟, 以使 (每个) 电芯的电压达到 3.0V 以上, 再进行快速充电。可用一计时器来实现该预充电步骤。如果在预充电规定时间内, (个别) 电池的电压仍未升到 3.0V 以上, 充电器应能够停止下一步快速充电, 并显示该/电池正处于非正常状态。

### 3. Storage 贮存

#### 3.1 储存条件

The battery shall be storied within  $-20\sim 35^{\circ}\text{C}$  range environmental condition.

If the battery has to be storied for a long time (Over 3 months), the environmental condition should be:  
Temperature:  $-20\sim 35^{\circ}\text{C}$

Humidity:  $\leq 75\%RH$

The voltage for a long time storage shall be  $3.7V\sim 3.9V$  range. Full charged storage is prohibited  
电池储存温度必须在  $-20\sim 35^{\circ}\text{C}$  的范围内。

长期存储电池 (超过 3 个月) 须置于温度为  $-20\sim 35^{\circ}\text{C}$ 、湿度为  $\leq 75\%RH$  的环境中。

贮存电压为  $3.7V\sim 3.9V$ 。禁止满电储存

#### 3.2 Please activate the battery once every 3 months according to the following method:

Charge at 0.2C to 4.2V, rest 5 min, then discharge with 0.2C to 3.0V/cell, rest 5 min, then charge at 0.2C to 3.9V.

请每隔 3 个月按下面方法激活电池一次:

0.2C 充电至 4.2V, 休息 5 分钟, 然后用 0.2C 放电至每颗电池 3.0V, 休息 5 分钟, 0.2C 充电 3.9V

### 4. Handling of Cells 电池操作注意事项

Since the battery is packed in soft package, to ensure its better performance, it's very important to carefully handle the battery

由于电池属于软包装, 为保证电池的性能不受损害, 必须小心对电池进行操作。

#### 4.1 The protection of soft aluminum foil 铝箔包装材料的防护

The soft aluminum packing foil is very easily damaged by sharp edge parts such as Ni-tabs, pins and needles.

- Don't strike battery with any sharp edge parts
- Trim your nail or wear glove before taking battery
- Clean worktable to make sure no any sharp particle

铝箔包装材料易被尖锐部件损伤, 诸如镍片, 尖针。

- 禁止用尖锐部件碰撞电池;
- 取放电池时, 请修短指甲或戴上手套;
- 应清洁工作环境, 避免有尖锐物体存在

#### 4.2 Folding edge 折边

The folding edge is form in battery process and passed all hermetic test

- Don't open or deform folding edge

折边在电池生产过程中已完成, 并通过了密封测试。

- 禁止打开或破坏折边。

#### 4.3 Mechanical shock 机械撞击

·Don't Fall, hit, bend battery body

·禁止坠落、冲击、弯折电池。

4.4 The curvature of the curve battery was prohibited to change or damage when handled, or the performance of the battery will be declined or the function will be lose.

·在使用弧形电池的过程中，不可改变或损坏电池的形状，否则会使电池的性能下降或完全丧失。

#### 5. Notice Designing Battery Pack 电池外壳设计注意事项

##### 5.1 Pack design 外壳设计

·Battery pack should have sufficient strength and battery should be protected from mechanical hock

·No Sharp edge components should be inside the pack containing the battery.

·电池外壳应有足够的机械强度以保证其内部电芯免受机械撞击。

·外壳内安装电芯的部位不应有锋利的边角。

#### 6. Notice for Assembling Battery Pack 电池与外壳组装注意事项

##### 6.1 Cell fixing 电池的安裝

·The battery should be fixed to the battery pack by its large surface area.

·No cell movement in the battery pack should be allowed.

·应将电池的宽面安装在外壳内；

·电池不得在壳内活动。

#### 7. Others 其它事项

##### 7.1 Prevention of short circuit within a battery pack 电池短路预防

Enough insulation layers between wiring and the cells shall be used to maintain extra safety protection.

线与电芯之间需要做充分绝缘，保持电池安全

##### 7.2 Prohibition of disassembling 严禁拆卸电池

###### 1) Never disassemble the cells 在任何情况下不得拆卸电池

The disassembling may generate internal short circuit in the cell, which may cause gassing, firing, or other problems.

拆卸电池可能会导致内部短路，进而引起鼓气、着火及其它问题。

###### 2) Electrolyte is harmful 电解液有害

LIP battery should not have liquid from electrolyte flowing, but in case the electrolyte come into contact with the skin, or eyes, physicians shall flush the electrolyte immediately with fresh water and medical advice is to be sought.

聚合物锂电池理论上不存在流动的电解液，但万一有电解液泄漏而接触到皮肤、眼睛或身体其它部位，应立即用清水冲洗电解液并就医。

##### 7.3 Prohibition of dumping of cells into fire 严禁将电池投入火中

Never incinerate nor dispose the cells in fire. These may cause firing of the cells, which is very dangerous and is prohibited.

在任何情况下，不得燃烧电池或将电池投入火中，否则会引起电芯燃烧，这是非常危险的，应绝对禁止。

##### 7.4 Prohibition of cells immersion into liquid such as water 严禁将电池浸入液体，如水

The cells shall never be soaked with liquids such as water, seawater drinks such as soft drinks, juices coffee or others.

不得将电池浸泡液体，如淡水、海水、饮料（果汁、咖啡等）。

#### 7.5 Battery cells replacement 电芯的更换

The battery replacement shall be done only by either cells supplier or device supplier and never be done by the user.

更换电芯应由电芯供应商或设备供应商完成，用户不得自行更换。

#### 7.6 Prohibition of use of damaged cells 禁止使用已损坏的电池

The cells might be damaged during shipping by shock. If any abnormal features of the cells are found such as damages in a plastic envelop of the cell, deformation of the cell package, smelling of electrolyte, electrolyte leakage and others, the cells shall never be used any more.

The cells with a smell of the electrolyte or a leakage shall be placed away from fire to avoid firing.

电池在运输过程中可能因撞击等原因而损坏，若发现电池有任何异常特征，如电池塑料封边损坏，外壳破损，闻到电解液气体，电解液泄漏等，该电池不得使用。有电解液泄漏或散发电解液气味的电池应远离火源以避免着火。

#### 7.7 Other Chemical Reaction 其它的化学反应

Because batteries utilize a chemical reaction, battery performance will deteriorate over time even if stored for a long period of time without being used. In addition, if the various usage conditions such as charge, discharge, ambient temperature, etc. are not maintained within the specified ranges the life expectancy of the battery may be shortened or the device in which the battery is used may be damaged by electrolyte leakage. If the batteries cannot maintain a charge for long periods of time, even when they are charged correctly, this may indicate it is time to change the battery.

电池是利用化学反应产生电量，电池性能会随时间变差，即使电池长时间储存而不使用。另外，各种各样的使用方法，像充电、放电及环境温度，等等不能在本规格书规定的范围时的情形，会减小电池的期望寿命，或者会使仪器设备由于电池漏液而损坏。即使充电正确，电池长时间不能再充电，那就要更换电池了。

#### 7.8 Note: Any other items which are not covered in this specification shall be agreed by both parties

注意：任何本产品规格书未包含的其它条款，应由双方协议确定。

#### 7.9 Period of warranty 保质期

The period of warranty is 12months from the date of shipment.

保质期为出厂后的 12 个月