

AC / DC Filter, High Symmetrical Attenuation

new



See below:
[Approvals and Compliances](#)

Description

- Filter for 277 VAC or 400 VDC applications
- 1-stage
- Compact filter with high symmetrical attenuation

Unique Selling Proposition

- For high AC- or DC-voltages
- Excellent symmetrical attenuation
- Completely enclosed steel housing
- Optional overvoltage protection

Characteristics

- For 277 VAC applications in North America WYE 480/277 volt system
- For 400 VDC applications e.g. data center
- Especially designed for applications with symmetrical noise caused by switching semiconductors
- Suitable for use in equipment according to IEC/UL 62368-1
- Suitable for use in medical equipment according to IEC/UL 60601-1 (1 MOOP, 1 MOPP)

Other versions on request

- Version with varistor for overvoltage protection

Weblinks

[pdf data sheet](#), [html datasheet](#), [General Product Information](#), [Approvals](#), [Distributor-Stock-Check](#), [Detailed request for product](#), [Landing Page](#)

Technical Data

| | |
|---------------------------------|---|
| Ratings IEC | 1 - 20A @ Ta 40 °C / 277 VAC; 50Hz 1 - 20 A @ Tu 40 °C / 277 VDC |
| Ratings UL/CSA | 1 - 20A @ Ta 40 °C / 277 VAC; 60Hz 1 - 20 A @ Tu 40 °C / 400 VDC |
| Leakage Current | industrial < 1mA (250V / 60Hz) |
| Dielectric Strength | > 1.7 kVDC between L-N > 2.7 kVDC between L/N-PE Test voltage (2 sec) |
| Allowable Operation Temperature | -40 °C to 100 °C |
| Climatic Category | 40/100/21 acc. to IEC 60068-1 |
| Protection Class | Suitable for appliances with protection class I acc. to IEC 61140 |
| Terminal | Quick connect terminal 6.3 x 0.8 mm |
| Material | Metal |

| | |
|-------------|--|
| Line Filter | Standard, medical and industrial version, IEC 60939, UL 1283, CSA C22.2 no. 8 Technical Details |
| MTBF | > 200'000h acc. to MIL-HB-217 F |

Approvals and Compliances

Detailed information on product approvals, code requirements, usage instructions and detailed test conditions can be looked up in [Details about Approvals](#)

SCHURTER products are designed for use in industrial environments. They have approvals from independent testing bodies according to national and international standards. Products with specific characteristics and requirements such as required in the automotive sector according to IATF 16949, medical technology according to ISO 13485 or in the aerospace industry can be offered exclusively with customer-specific, individual agreements by SCHURTER.

Approvals





The approval mark is used by the testing authorities to certify compliance with the safety requirements placed on electronic products.

Approval Reference Type: FMAB HV

| Approval Logo | Certificates | Certification Body | Description |
|---------------|-------------------------------|--------------------|------------------------------|
| | VDE Approvals | VDE | Certificate Number: 40050001 |
| | UL Approvals | UL | UR File Number: E495089 |

Product standards

Product standards that are referenced

| Organization | Design | Standard | Description |
|--|-----------------------|-----------------|--|
|  | Designed according to | IEC 60939 | Passive filters for suppressing electromagnetic interference |
|  | Designed according to | IEC 61058-1 | Switches for appliances. Part 1. General requirements |
|  | Designed according to | UL 1283 | Electromagnetic interference filters |
|  | Designed according to | CSA C22.2 no. 8 | Electromagnetic interference (EMI) filters |





Application standards

Application standards where the product can be used

| Organization | Design | Standard | Description |
|--|--------------------------------|----------------|---|
|  | Suitable for applications acc. | IEC/UL 62368-1 | Audio/video, information and communication technology equipment - Part 1: Safety requirements |

Compliances

The product complies with following Guide Lines

| Identification | Details | Initiator | Description |
|--|--|-------------|---|
|  | CE declaration of conformity | SCHURTER AG | The CE marking declares that the product complies with the applicable requirements laid down in the harmonisation of Community legislation on its affixing in accordance with EU Regulation 765/2008. |
|  | UKCA declaration of conformity | SCHURTER AG | The UKCA marking declares that the product complies with the applicable requirements laid down in the British Amendment of Regulation (EC) 765/2008. |
|  | RoHS | SCHURTER AG | Directive RoHS 2011/65/EU, Amendment (EU) 2015/863 |
|  | China RoHS | SCHURTER AG | The law SJ / T 11363-2006 (China RoHS) has been in force since 1 March 2007. It is similar to the EU directive RoHS. |
|  | REACH | SCHURTER AG | On 1 June 2007, Regulation (EC) No 1907/2006 on the Registration, Evaluation, Authorization and Restriction of Chemicals 1 (abbreviated as "REACH") entered into force. |

Dimension [mm]

Case PG

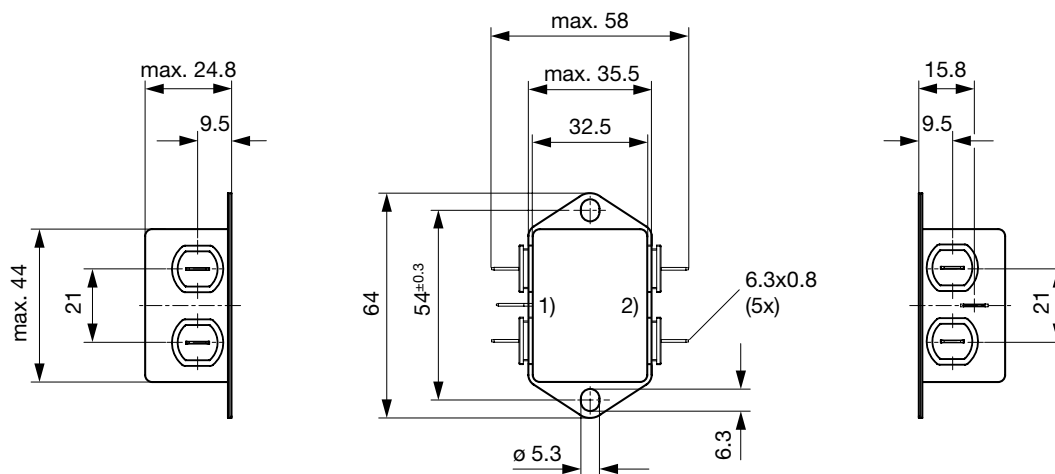

1) Line, 2) Load

Case PH

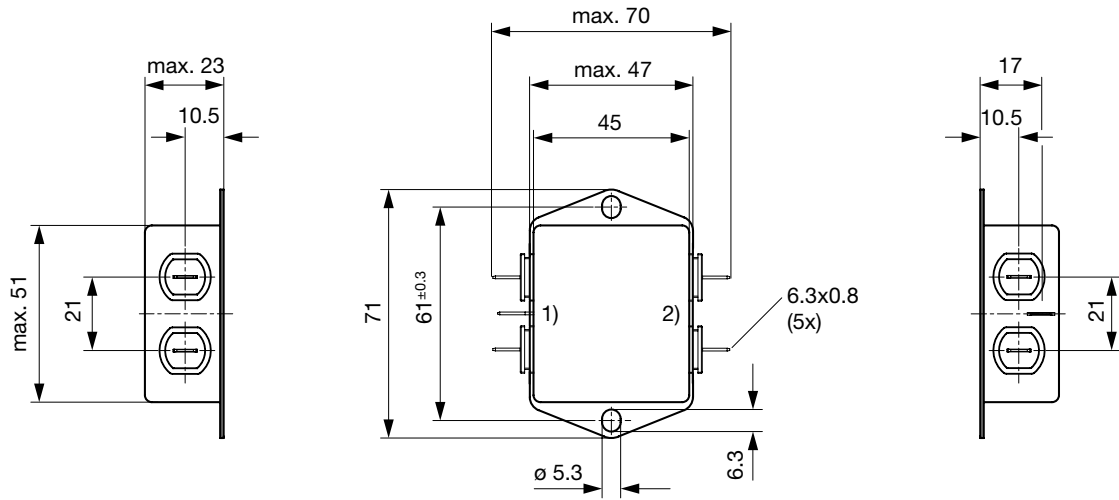

1) Line, 2) Load

Case PI

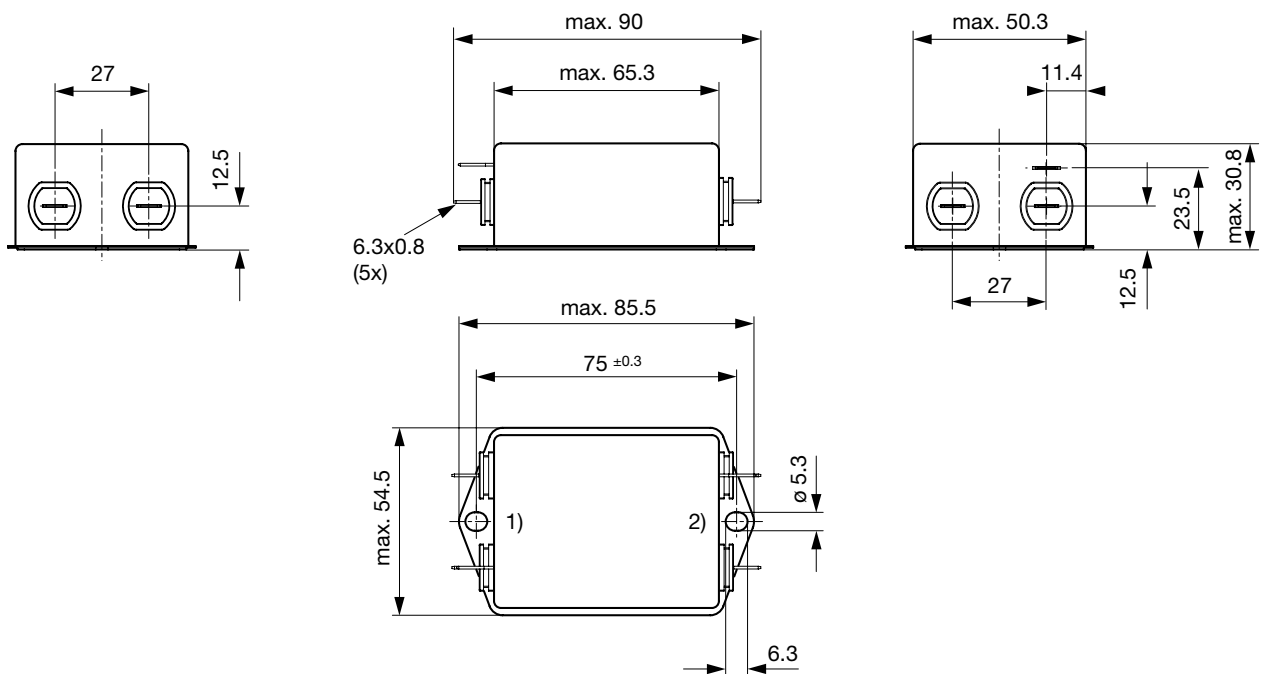

1) Line, 2) Load

Case UB

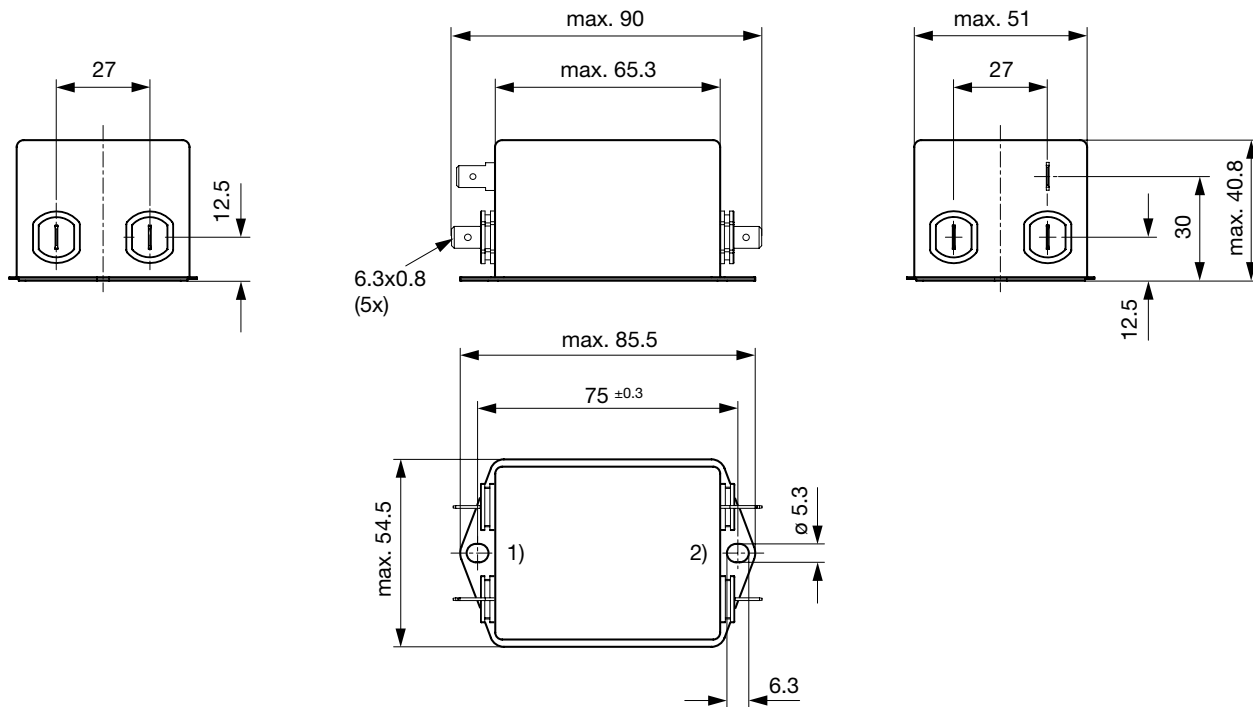

1) Line, 2) Load

Diagrams

Standard Version or medical M80

Medical Version (M5)

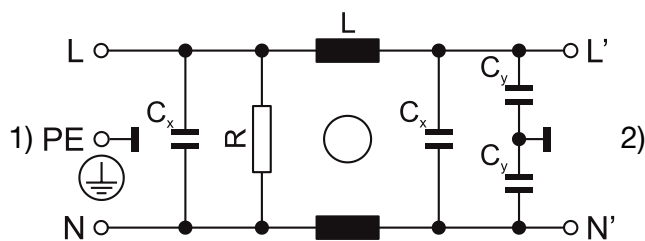

1) Line
2) Load

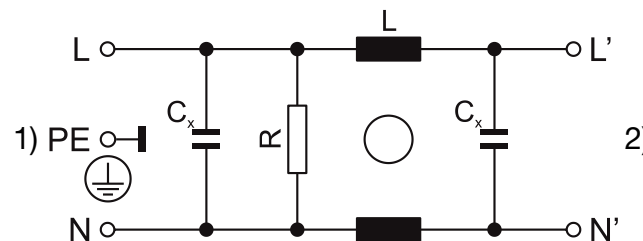

1) Line
2) Load

Attenuation Loss . . . 0.1/100Ω differential mode 100/0.1Ω differential mode - - - 50Ω differential mode ____ 50Ω common mode
 Standard version

1 A

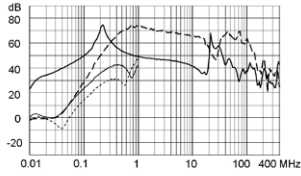

3 A

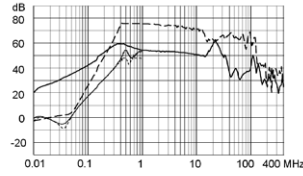

4 A

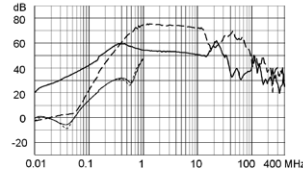

6 A

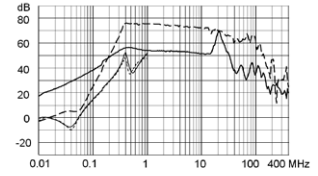

8 A

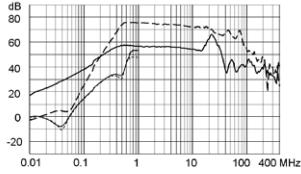

10 A

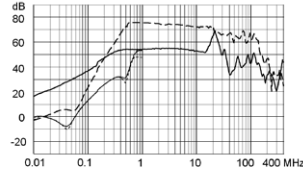

12 A

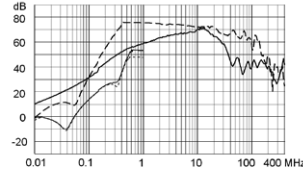

16 A

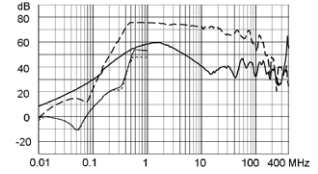

20 A

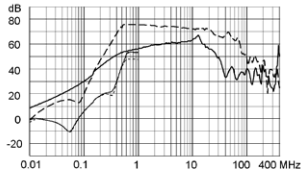

Medical version (M5)

1 A

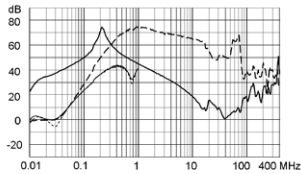

3 A

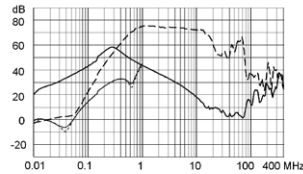

4 A

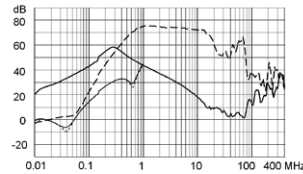

6 A

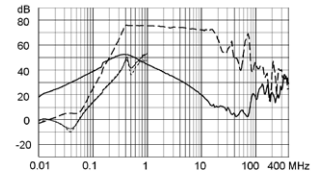

8 A

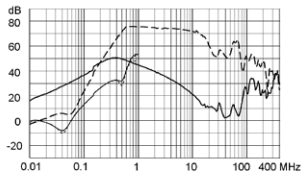

All Variants

| Rated current | Filter-Type | Terminal | Lea- ga- ge | Ri | Power Loss | Weight | Housing | Packa- ging | Order Number | |
|---------------|--------------------|-------------------------------------|-------------------|------|---------------|--------|---------|----------------|--------------|---|
| [A] | | | [mA] | [mΩ] | [W] | [g] | | [ST] | | |
| 1 | Standard version | Quick connect terminal 6.3 x 0.8 mm | 0.5 | 560 | 1 | 72 g | PG | 20 | 3-109-227 | ■ |
| 3 | Standard version | Quick connect terminal 6.3 x 0.8 mm | 0.5 | 83 | 1.5 | 104 g | PH | 15 | 3-109-228 | ■ |
| 4 | Standard version | Quick connect terminal 6.3 x 0.8 mm | 0.5 | 53 | 1.7 | 108 g | PH | 15 | 3-109-229 | ■ |
| 6 | Standard version | Quick connect terminal 6.3 x 0.8 mm | 0.5 | 32.5 | 2.4 | 109 g | PH | 15 | 3-109-230 | ■ |
| 8 | Standard version | Quick connect terminal 6.3 x 0.8 mm | 0.5 | 29.2 | 3.8 | 190 g | PI | 10 | 3-109-231 | ■ |
| 10 | Industrial version | Quick connect terminal 6.3 x 0.8 mm | 1 | 22.8 | 4.6 | 200 g | PI | 10 | 3-109-232 | ■ |

| Rated current [A] | Filter-Type | Terminal | Leakage [mA] | Ri [mΩ] | Power Loss [W] | Weight [g] | Housing | Packaging [ST] | Order Number | |
|-------------------|--------------------|-------------------------------------|--------------|---------|----------------|------------|---------|----------------|--------------|---|
| 12 | Industrial version | Quick connect terminal 6.3 x 0.8 mm | 1 | 13.2 | 3.8 | 201 g | PI | 10 | 3-109-233 | ■ |
| 16 | Industrial version | Quick connect terminal 6.3 x 0.8 mm | 1 | 7.2 | 3.7 | 308 g | UB | 10 | 3-109-234 | ■ |
| 20 | Industrial version | Quick connect terminal 6.3 x 0.8 mm | 1 | 8 | 4.8 | 322 g | UB | 10 | 3-109-235 | ■ |
| 1 | Medical (M5) | Quick connect terminal 6.3 x 0.8 mm | 0.005 | 560 | 1 | 72 g | PG | 20 | 3-109-236 | |
| 3 | Medical (M5) | Quick connect terminal 6.3 x 0.8 mm | 0.005 | 83 | 1.5 | 104 g | PH | 15 | 3-109-237 | |
| 4 | Medical (M5) | Quick connect terminal 6.3 x 0.8 mm | 0.005 | 53 | 1.7 | 108 g | PH | 15 | 3-109-238 | |
| 6 | Medical (M5) | Quick connect terminal 6.3 x 0.8 mm | 0.005 | 32.5 | 2.4 | 109 g | PH | 15 | 3-109-239 | |
| 8 | Medical (M5) | Quick connect terminal 6.3 x 0.8 mm | 0.005 | 29.2 | 3.8 | 190 g | PI | 10 | 3-109-240 | |
| 10 | Medical (M5) | Quick connect terminal 6.3 x 0.8 mm | 0.005 | 22.8 | 4.6 | 200 g | PI | 10 | 3-109-241 | |
| 12 | Medical (M5) | Quick connect terminal 6.3 x 0.8 mm | 0.005 | 13.2 | 3.8 | 201 g | PI | 10 | 3-109-242 | |
| 16 | Medical (M5) | Quick connect terminal 6.3 x 0.8 mm | 0.005 | 7.2 | 3.7 | 308 g | UB | 10 | 3-109-243 | |
| 20 | Medical (M5) | Quick connect terminal 6.3 x 0.8 mm | 0.005 | 8 | 4.8 | 322 g | UB | 10 | 3-109-244 | |
| 1 | Medical (M80) | Quick connect terminal 6.3 x 0.8 mm | 0.08 | 560 | 1 | 72 g | PG | 20 | 3-109-426 | |
| 3 | Medical (M80) | Quick connect terminal 6.3 x 0.8 mm | 0.08 | 83 | 1.5 | 104 g | PH | 15 | 3-109-427 | |
| 4 | Medical (M80) | Quick connect terminal 6.3 x 0.8 mm | 0.08 | 53 | 1.7 | 108 g | PH | 15 | 3-109-428 | |
| 6 | Medical (M80) | Quick connect terminal 6.3 x 0.8 mm | 0.08 | 32.5 | 2.4 | 109 g | PH | 15 | 3-109-429 | |
| 8 | Medical (M80) | Quick connect terminal 6.3 x 0.8 mm | 0.08 | 29.2 | 3.8 | 190 g | PI | 10 | 3-109-430 | |
| 10 | Medical (M80) | Quick connect terminal 6.3 x 0.8 mm | 0.08 | 22.8 | 4.6 | 200 g | PI | 10 | 3-109-431 | |
| 12 | Medical (M80) | Quick connect terminal 6.3 x 0.8 mm | 0.08 | 13.2 | 3.8 | 201 g | PI | 10 | 3-109-432 | |
| 16 | Medical (M80) | Quick connect terminal 6.3 x 0.8 mm | 0.08 | 7.2 | 3.7 | 308 g | UB | 10 | 3-109-433 | |
| 20 | Medical (M80) | Quick connect terminal 6.3 x 0.8 mm | 0.08 | 8 | 4.8 | 322 g | UB | 10 | 3-109-434 | |

■ Most Popular.

Availability for all products can be searched real-time: <https://www.schurter.com/en/Stock-Check/Stock-Check-SCHURTER>

Accessories

Description



[DIN_Rail_Kit](#)
 Mounting accessory for compact 1- and 3-phase filters