

NUS6189MN

Low Profile Overvoltage Protection IC with Integrated MOSFET

This device represents a new level of safety and integration by combining an overvoltage protection circuit (OVP) with a 30 V P-channel power MOSFET, a low $V_{CE(SAT)}$ transistor, and low $R_{DS(on)}$ power MOSFET or charging. The OVP is specifically designed to protect sensitive electronic circuitry from overvoltage transients and power supply faults. During such events, the IC quickly disconnects the input supply from the load, thus protecting it. The integration of the additional transistor and power MOSFET reduces layout space and promotes better charging performance.

The IC is optimized for applications that use an external AC-DC adapter or a car accessory charger to power a portable product or recharge its internal batteries.

Features

- Overvoltage Turn-Off Time of Less Than 1.0 μ s
- Accurate Voltage Threshold of 6.85 V, Nominal
- Undervoltage Lockout Protection; 2.8 V, Nominal
- High Accuracy Undervoltage Threshold of 2.0%
- -30 V Integrated P-Channel Power MOSFET
- Low $R_{DS(on)}$ = 50 m Ω @ -4.5 V
- High Performance -12 V P-Channel Power MOSFET
- Single-Low $V_{ce(sat)}$ Transistors as Charging Power Mux
- Compact 3.0 x 4.0 mm QFN Package
- Maximum Solder Reflow Temperature @ 260°C
- This is a Pb-Free Device

Benefits

- Provide Battery Protection
- Integrated Solution Offers Cost and Space Savings
- Integrated Solution Improves System Reliability
- Optimized for Commercial PMUs from Top Suppliers

Applications

- Portable Computers and PDAs
- Cell Phones and Handheld Products
- Digital Cameras



ON Semiconductor®

<http://onsemi.com>



QFN22
CASE 485AT

MARKING DIAGRAM

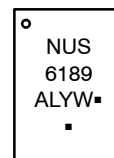

NUS6189 = Specific Device Code
A = Assembly Location
L = Wafer Lot
Y = Year
W = Work Week
▪ = Pb-Free Package

(Note: Microdot may be in either location)

ORDERING INFORMATION

Device	Package	Shipping†
NUS6189MNTWG	QFN22 (Pb-Free)	3000 / Tape & Reel

†For information on tape and reel specifications, including part orientation and tape sizes, please refer to our Tape and Reel Packaging Specification Brochure, BRD8011/D.

NUS6189MN

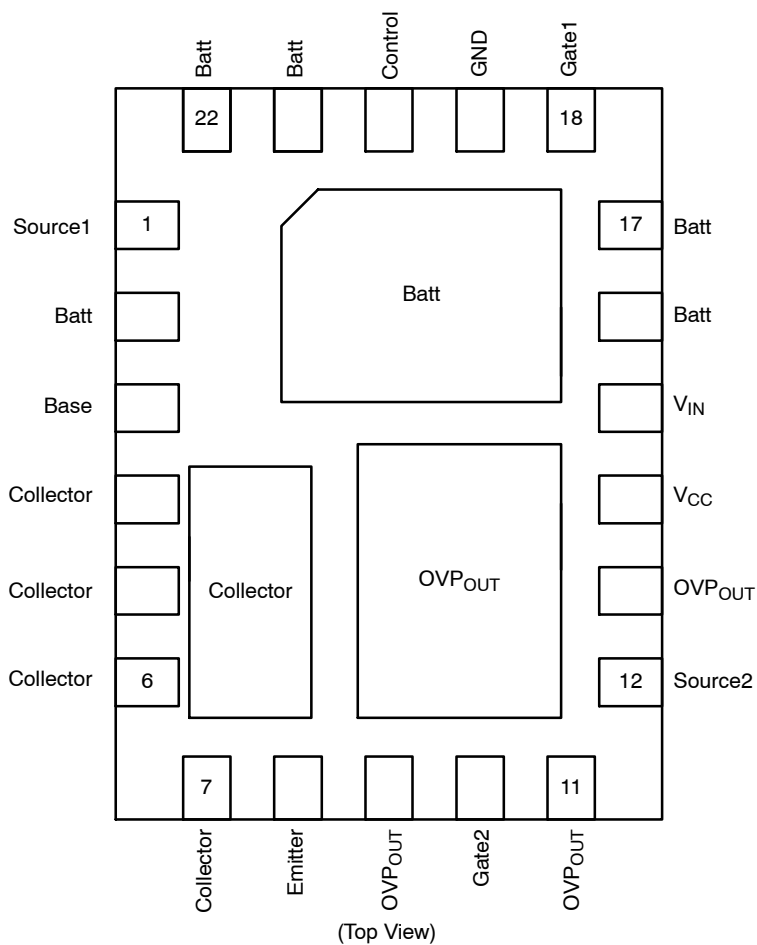

Figure 1. Pinout

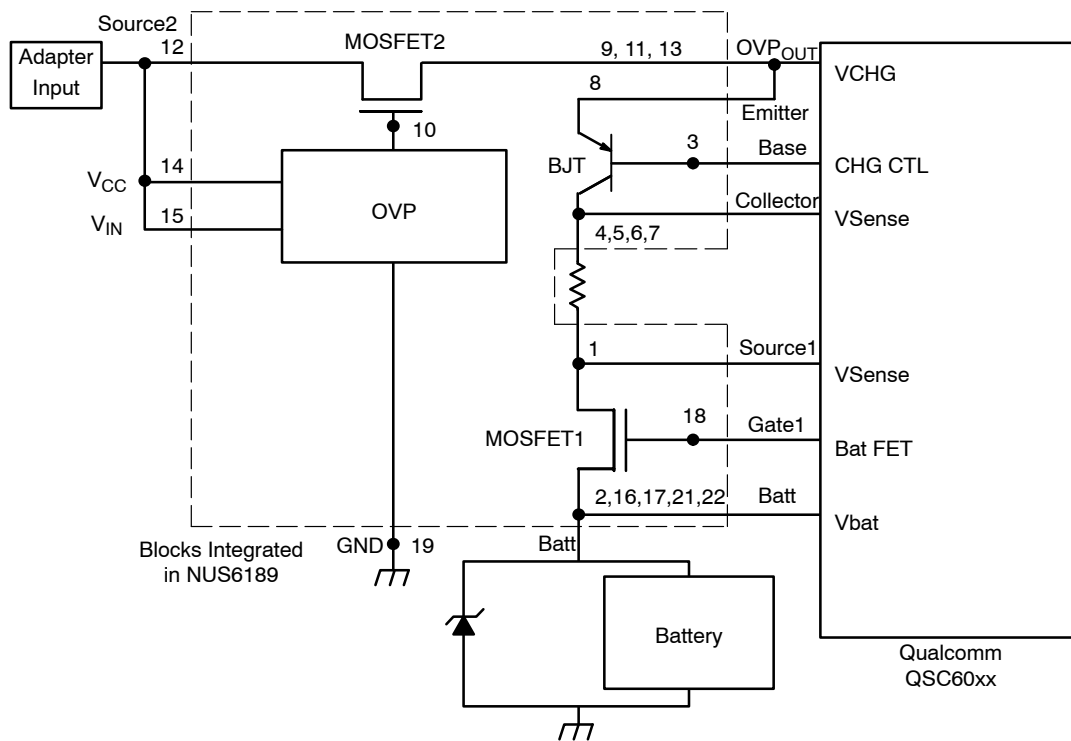

Figure 2. Typical Charging Solution for Qualcomm QSC60xx

NUS6189MN

FUNCTIONAL PIN DESCRIPTIONS

Pin	Function	Description
1	Source 1	This pin is the source of MOSFET1 and connects to the more negative Vsense pin of the PMIC and to the more negative side of the current sense resistor.
2, 16, 17, 21, 22	Batt	These pins are the drain of MOSFET2 and connect to the battery and the Vbat pin of the PMIC.
3	Base	The base of the internal bipolar transistor is connected to this pin. It connects to the Charge Control pin of the PMIC.
4, 5, 6, 7	Collector	The collector of the internal bipolar transistor connects to these pins and should be connected to the more positive side of the current sense resistor as well as the more positive Vsense pin of the PMIC.
8	Emitter	This pin is connected to the emitter of the bipolar transistor. It should be connected externally to the OVP _{OUT} pins.
9, 11, 13	OVP _{OUT}	These pins are the output of the OVP circuit. Internally they connect to the drain of MOSFET2. These pins connect externally to the Vcharge pin of the PMIC.
10	Gate2	This pin is the gate of MOSFET2. It is not normally connected to external circuitry.
12	Source 2	The source of the OVP FET is connected to this pin. This pin needs to be connected to pins 14 & 15.
14	V _{CC}	This pin is the V _{CC} pin of the OVP chip. It needs to be connected to pins 12 and 15.
15	V _{IN}	This pin senses the output voltage of the charger. If the voltage on this input rises above the over-voltage threshold (V _{TH}), the OVP _{OUT} pin will be driven to within 1.0 V of V _{IN} , thus disconnecting the FET. The nominal threshold level is 6.85 V. This pin needs to be connected to pins 12 and 14.
18	Gate1	This pin is the gate of MOSFET1. It connects to the Bat FET pin of the PMIC.
19	Gnd	This is the ground reference pin for the OVP chip.
20	Control	This logic signal is used to control the state of OVP _{OUT} and turn-on/off the P-channel MOSFET. A logic level high results in the OVP _{OUT} signal being driven to within 1.0 V of V _{CC} which turns off MOSFET2. If this pin is not used, it should be connected to ground.

NUS6189MN

MAXIMUM RATINGS

Rating	Symbol	Value	Unit
V_{IN} to Ground	V_{IN}	-0.3 to 30	V
Gate2 Voltage to Ground	V_{G2}	-0.3 to 30	V
Control Pin to Ground	V_{CNTRL}	-0.3 to 13	V
Shunt Voltage (OVP_{OUT} to Batt)	V_{shunt}	12	V
Maximum Power Dissipation ($T_A = 50^\circ\text{C}$, Notes 1 & 3)	P_D	1.2	W
Thermal Resistance, Junction-to-Air (Note 1) Average θ for chip, minimum copper Maximum θ for power device, minimum copper Average θ , for chip (Note 2) Maximum θ for power device (Note 1) Average θ for chip (Note 1) Maximum θ for power device (Note 1)	θ_{J-A}	137 145 98 103 77 82	$^\circ\text{C/W}$
Operating Case Temperature (Note 4)	T_{Cmax}	125	$^\circ\text{C}$
Operating Ambient Temperature ($P_D = 0.5$ W, Note 1)	T_{Amb}	109	$^\circ\text{C}$
Operating Junction Temperature (All Dice)	T_{Jmax}	150	$^\circ\text{C}$
Thermal Resistance Junction-to-Case (Note 4)	Ψ_{JC}	30	$^\circ\text{C/W}$
Storage Temperature Range	T_{stg}	-65 to 150	$^\circ\text{C}$
Continuous Input Current ($T_A = 50^\circ\text{C}$, Notes 1 & 3)	I_{max}	2.6	A
Gate-to-Source Voltage MOSFET1	V_{GS1}	± 8.0	V
Drain-to-Source Voltage MOSFET1	V_{DS1}	-12	V
Drain-to-Source Voltage MOSFET2	V_{DS2}	-30	V
Collector-Emitter Voltage BJT	V_{CEO}	-20	V
Collector-Base Voltage BJT	V_{CBO}	-20	V
Emitter-Base Voltage BJT	V_{EBO}	-7.0	V

Stresses exceeding Maximum Ratings may damage the device. Maximum Ratings are stress ratings only. Functional operation above the Recommended Operating Conditions is not implied. Extended exposure to stresses above the Recommended Operating Conditions may affect device reliability.

1. Surface-mounted on FR4 board using 1 inch sq pad size (Cu area = 1.127 in sq [1 oz] including traces).
2. Surface-mounted on FR4 board using 0.25 inch sq pad size (Cu area = 0.37 in sq [1 oz] including traces).
3. $V_{IN} = 6.0$ V, all power devices fully enhanced.
4. Surface-mounted on FR4 board using 400 mm sq pad size, 4 oz Cu, $P_D < 800$ mW.

NUS6189MN

ELECTRICAL CHARACTERISTICS (T_J = 25°C, CNTRL ≤ 1.5 V, V_{CC} = 6.0 V, unless otherwise specified)

Characteristic	Symbol	Min	Typ	Max	Unit
----------------	--------	-----	-----	-----	------

OVP THRESHOLD

Input Threshold (V _{IN} Increasing)	V _{th}	6.65	6.85	7.08	V
Input Hysteresis (V _{IN} Decreasing)	V _{hyst}	50	150	200	mV
Input Impedance (V _{IN} = V _{th})	R _{IN}	70	150	–	kΩ

CONTROL INPUT

Control Voltage High (Output On)	V _{cntrlHI}	1.50	–	–	V
Control Voltage Low (Output Off)	V _{cntrlLO}	–	–	0.50	V
Control Current High (V _{ih} = 5.0 V)	I _{ih}	–	95	200	μA
Control Current Low (V _{il} = 0.5 V)	I _{il}	–	10	–	μA

OVP GATE DRIVE VOLTAGE

Gate2 Voltage High (V _{IN} = 8.0 V; I _{Source} = 10 mA)	V _{oh}	V _{IN} – 1.0	–	–	V
Gate2 Voltage High (V _{IN} = 8.0 V; I _{Source} = 0.25 mA)		V _{IN} – 0.25	–	–	
Gate2 Voltage High (V _{IN} = 8.0 V; I _{Source} = 0 mA)		V _{IN} – 0.1	–	–	
Gate2 Voltage Low (V _{IN} = 6.0 V; I _{Sink} = 0 mA, Control = 0 V)	V _{ol}	–	–	0.10	V
Gate2 Sink Current (V _{IN} < V _{Th} , OVP _{OUT} = 1.0 V, Note 5)	I _{Sink}	10	33	50	μA

TIMING

Turn on Delay – Input (V _{IN} stepped down from 8 to 6 V; measured at 50% point of OVP _{OUT} , Note 5)	t _{on_IN}	–	–	10	μs
Turn off Delay – Input (V _{IN} stepped up from 6.0 to 8.0 V; C _L = 12 nF Output > V _{IN} – 1.0 V)	t _{off_IN}	–	0.5	1.0	μs
Turn on Delay – Control (Control signal stepped down from 2.0 to 0.5 V; measured to 50% point of OVP _{OUT} , Note 5)	t _{on_CT}	–	–	10	μs
Turn off Delay – Control (Control signal stepped up from 0.5 to 2.0 V; C _L = 12 nF Output > V _{IN} – 1.0 V)	t _{off_CT}	–	1.0	2.0	μs

TOTAL DEVICE

V _{IN} Operating Voltage Range (Note 5)	V _{IN}	3.0	4.8	25	V
Input Bias Current	I _{Bias}	–	0.75	1.0	mA
Undervoltage Lockout (V _{IN} Decreasing)	V _{Lock}	2.5	2.8	3.0	V

OVP FET (MOSFET2) (T_J = 25°C, V_{CC} = 6.0 V, unless otherwise specified)

Voltage Drop (V _{IN} to OVP _{OUT} , V _{GS} = -4.5 V) I _{Load} = 0.6 A I _{Load} = 1.0 A I _{Load} = 1.0 A, T _J = 150°C (Note 5)	V _{OVP}	–	33	54	mV
		–	66	100	
		–	90	135	
On Resistance I _{Load} = 0.6 A I _{Load} = 1.0 A I _{Load} = 1.0 A, T _J = 150°C (Note 5)	R _{DS(on)}	–	50	90	mΩ
		–	52	100	
		–	90	135	
Off State Leakage Current T _J = 125°C	I _{Leak}	–	-0.1	-1.0	μA
		–	–	-100	

CHARGING BJT (T_J = 25°C, unless otherwise specified)

Collector-Emitter Cutoff Current (V _{CES} = -20 V, Note 5)	I _{CES}	–	–	-0.1	μA
DC Current Gain (I _B = -2.0 mA, V _{CE} = -2.0 V, Note 6)	h _{fe}	180	–	–	–
Collector-Emitter Saturation Voltage I _C = -1.0 A, I _B = -0.01 A I _C = -1.0 A, I _B = -0.1 A	V _{CE(sat)}	–	-0.10	-0.12	V
		–	-0.069	-0.09	

NUS6189MN

ELECTRICAL CHARACTERISTICS ($T_J = 25^\circ\text{C}$, $\text{CNTRL} \leq 1.5\text{ V}$, $V_{CC} = 6.0\text{ V}$, unless otherwise specified)

Characteristic	Symbol	Min	Typ	Max	Unit
Input Capacitance ($V_{EB} = -0.5\text{ V}$, $f = 1.0\text{ MHz}$, Note 5)	C_{ibo}	–	240	400	pF
Output Capacitance ($V_{CB} = -3.0\text{ V}$, $f = 1.0\text{ MHz}$, Note 5)	C_{obo}	–	50	100	pF

CHARGING FET (MOSFET1) ($T_J = 25^\circ\text{C}$, unless otherwise specified)

Voltage Drop Across FET $V_{GS} = -4.5\text{ V}$, $I_{Load} = 1.0\text{ A}$ $V_{GS} = -2.5\text{ V}$, $I_{Load} = 1.0\text{ A}$ $V_{GS} = -4.5\text{ V}$, $I_{Load} = 1.0\text{ A}$, $T_J = 150^\circ\text{C}$ (Note 5)	V_{DS}	– – –	32 44 62	40 50 70	mV
On Resistance $V_{GS} = -4.5\text{ V}$, $I_{Load} = 1.0\text{ A}$ $V_{GS} = -2.5\text{ V}$, $I_{Load} = 1.0\text{ A}$ $V_{GS} = -4.5\text{ V}$, $I_{Load} = 1.0\text{ A}$, $T_J = 150^\circ\text{C}$, (Note 5)	$R_{DS(on)}$	– – –	32 44 62	40 50 70	mV
Off State Leakage Current (Note 5) $T_J = 125^\circ\text{C}$	I_{Leak}	– –	-0.1 –	-1.0 -10	μA
Input Capacitance	C_{ISS}	–	1330	–	pF
Output Capacitance	C_{OSS}	–	200	–	pF
Reverse Transfer Capacitance	C_{RSS}	–	115	–	pF
Total Gate Charge (Note 5)	$Q_{G(TOT)}$	–	13	15.7	nC
Threshold Gate Charge	$Q_{G(TH)}$	–	1.5	–	nC
Gate-to-Source Charge	Q_{GS}	–	2.2	–	nC
Gate-to-Drain Charge	Q_{GD}	–	2.9	–	nC
Gate Resistance	R_G	–	14.4	–	Ω
Forward Transconductance ($V_{DS} = -6\text{ V}$, $I_D = 1.0\text{ A}$)	g_{fs}	–	0.9	–	S
Gate Threshold Voltage ($V_{GS} = V_{DS}$, $I_D = -250\text{ }\mu\text{A}$)	$V_{GS(th)}$	-0.45	-0.67	-1.1	V
Negative Threshold Temperature Coefficient	$V_{GS(th)}/T_J$	–	2.7	–	mV/ $^\circ\text{C}$

5. Guaranteed by design.

6. Pulsed Condition: Pulse Width = 300 μs , Duty Cycle $\leq 2\%$.

TYPICAL CHARACTERISTICS – 12V, P-CHANNEL MOSFETS (MOSFET1 – CHARGING)

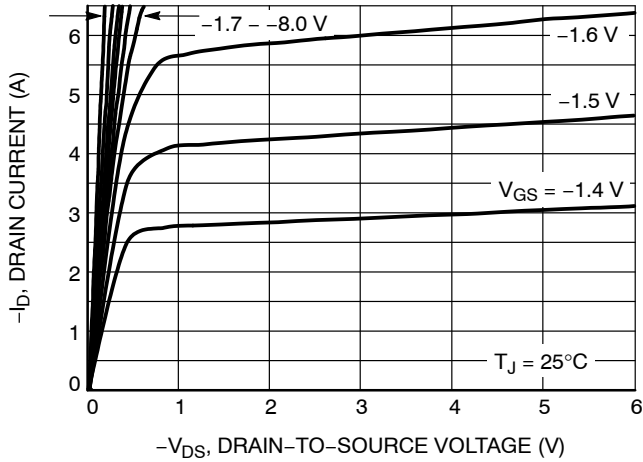

Figure 3. On-Region Characteristics

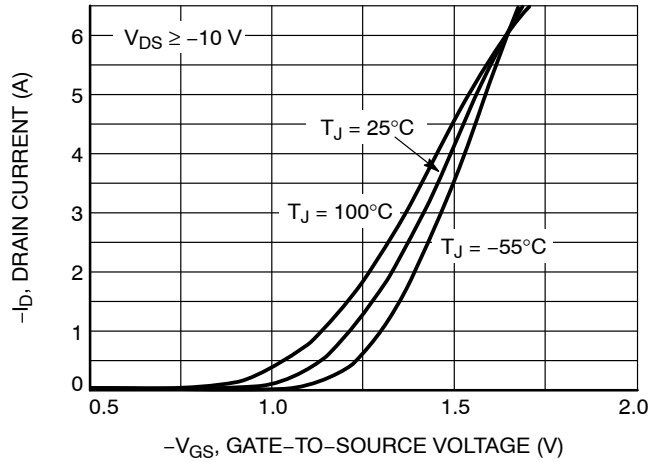

Figure 4. Transfer Characteristics

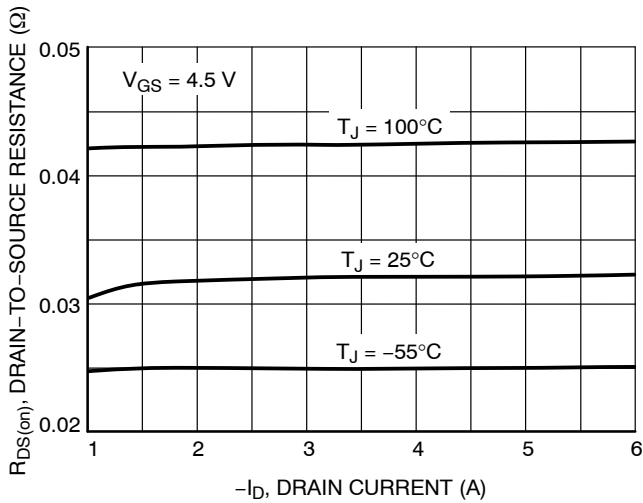

Figure 5. On-Resistance vs. Drain Current

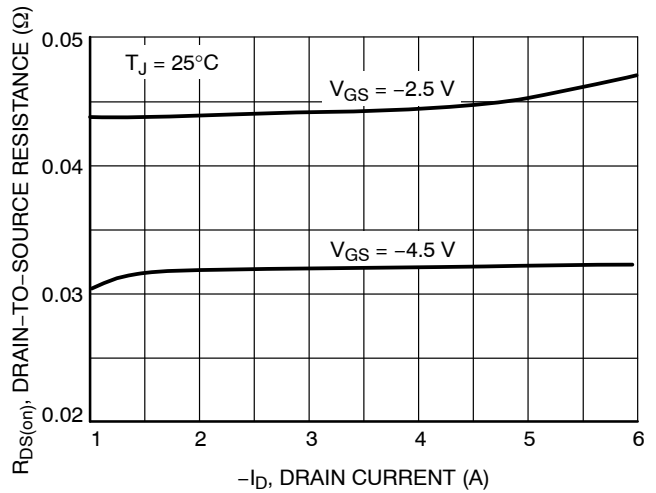

Figure 6. On-Resistance vs. Drain Current and Gate Voltage

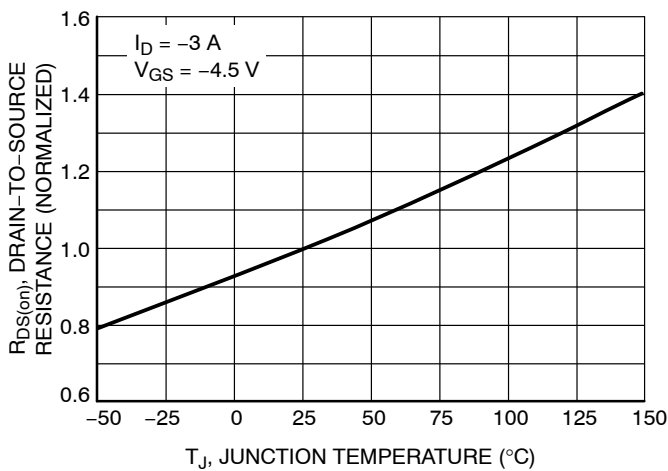

Figure 7. On-Resistance Variation with Temperature

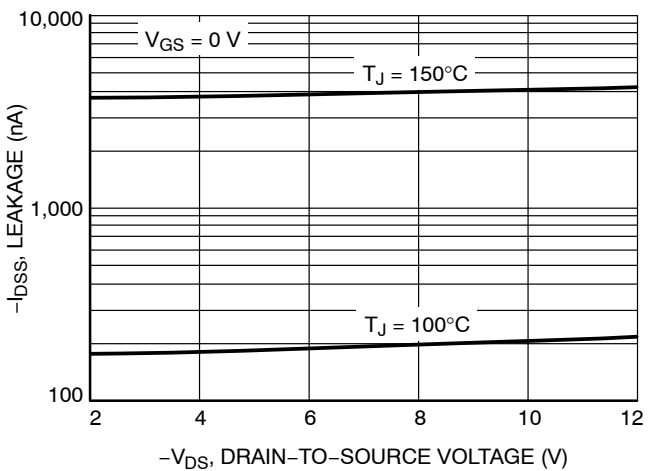

Figure 8. Drain-to-Source Leakage Current vs. Voltage

TYPICAL CHARACTERISTICS – 12V, P-CANNEL MOSFETS (MOSFET1 – CHARGING)

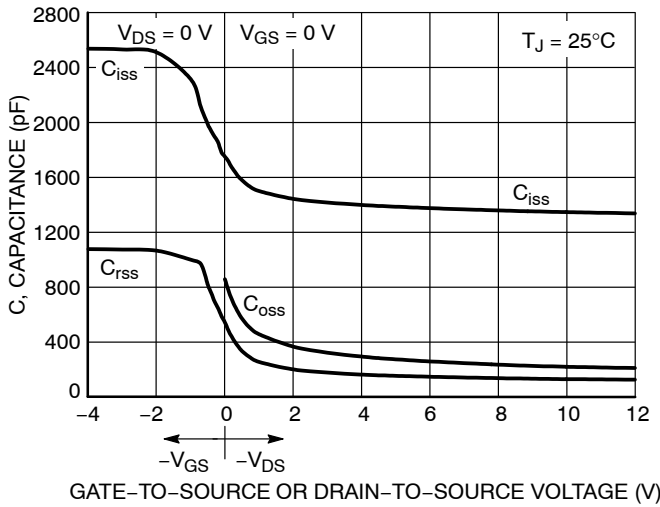

Figure 9. Capacitance Variation

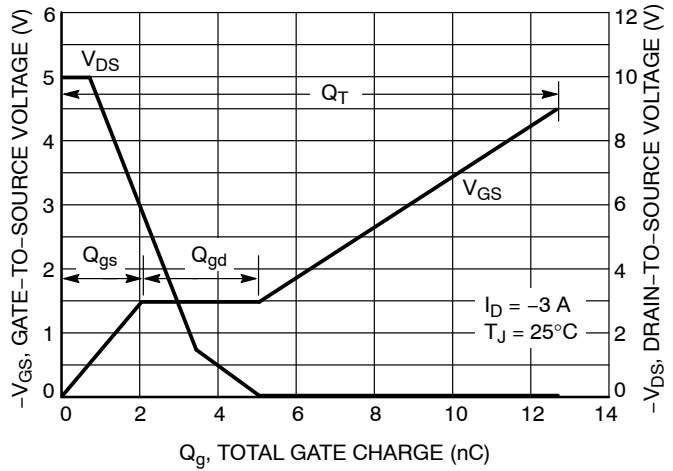

Figure 10. Gate-to-Source and Drain-to-Source Voltage vs. Total Charge

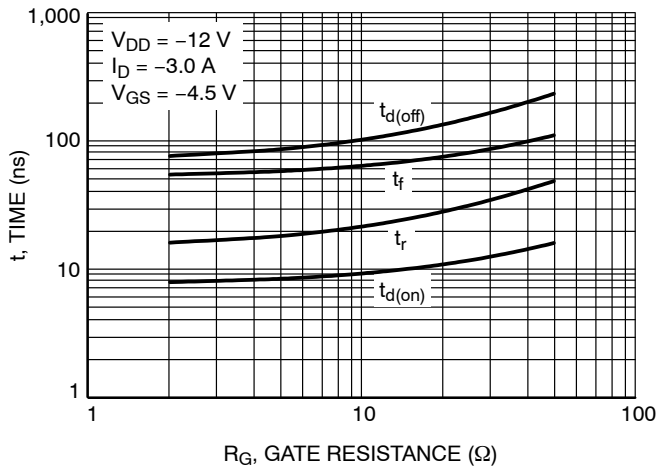

Figure 11. Resistive Switching Time Variation vs. Gate Resistance

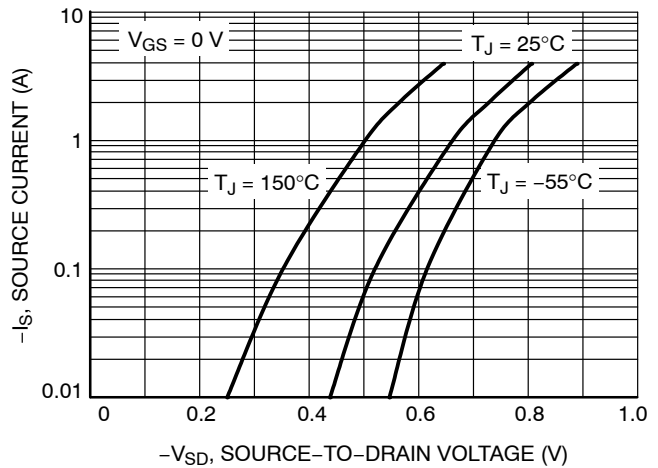
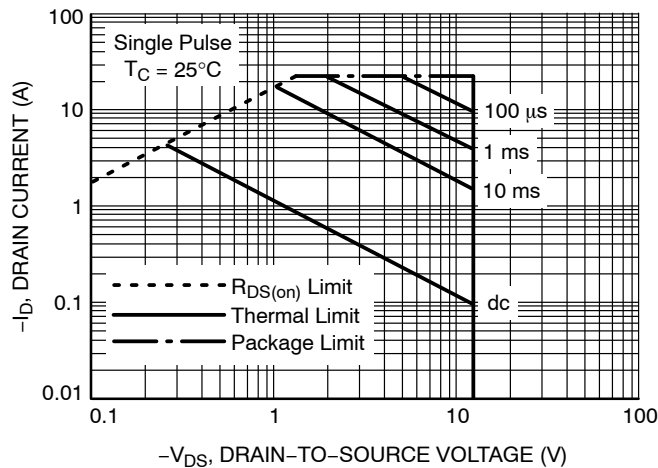

Figure 12. Diode Forward Voltage vs. Current



Mounted on 2" sq. FR4 board (0.5" sq. 2 oz. Cu single sided) with MOSFET die operating.

Figure 13. Maximum Rated Forward Biased Safe Operating Area

NUS6189MN

TYPICAL CHARACTERISTICS – 12V, P-CHANNEL MOSFETS (MOSFET1 – CHARGING)

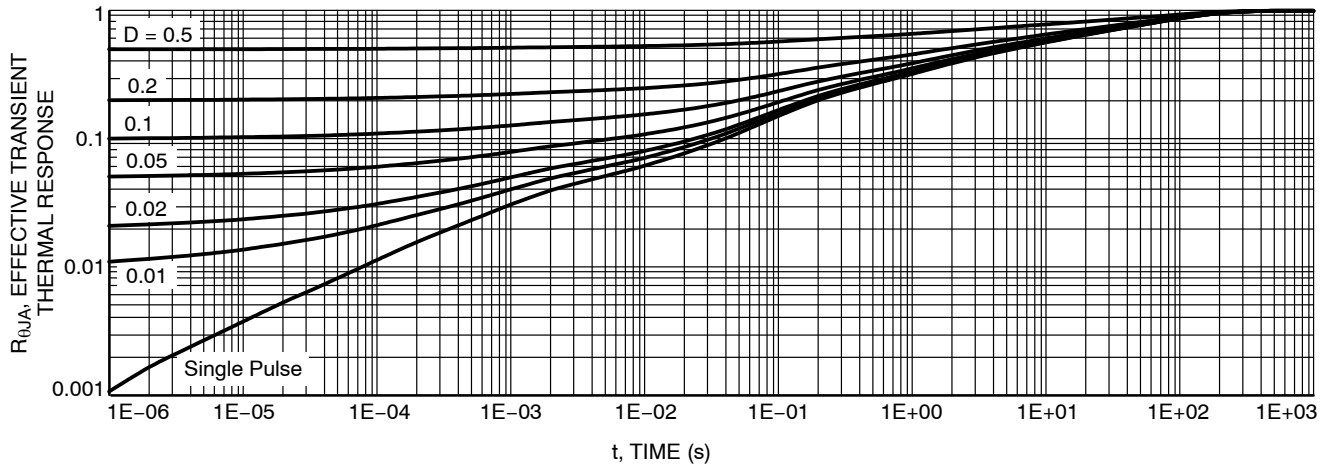

Figure 14. FET Thermal Response

TYPICAL CHARACTERISTICS – SINGLE PNP TRANSISTOR (BJT – CHARGING)

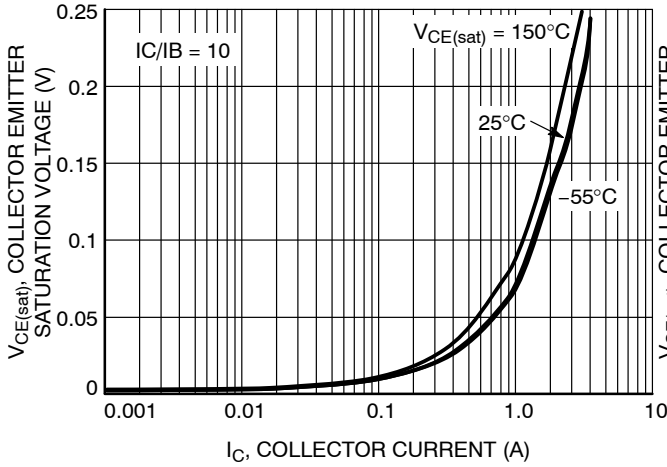

Figure 15. Collector Emitter Saturation Voltage vs. Collector Current

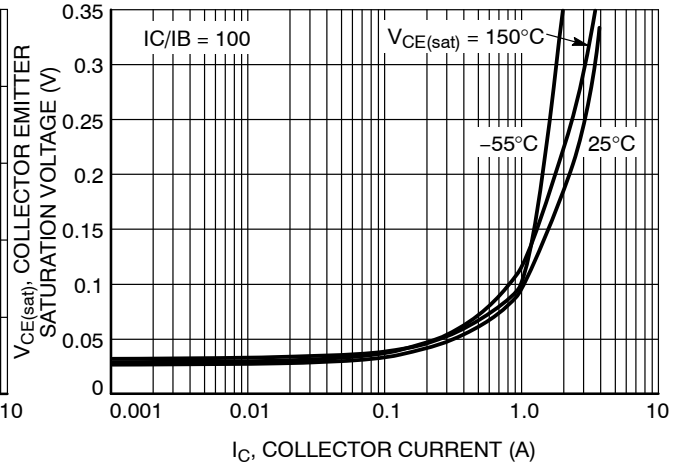

Figure 16. Collector Emitter Saturation Voltage vs. Collector Current

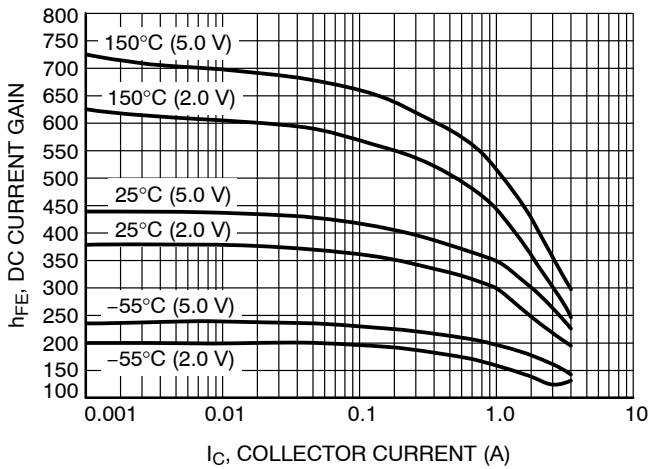

Figure 17. DC Current Gain vs. Collector Current

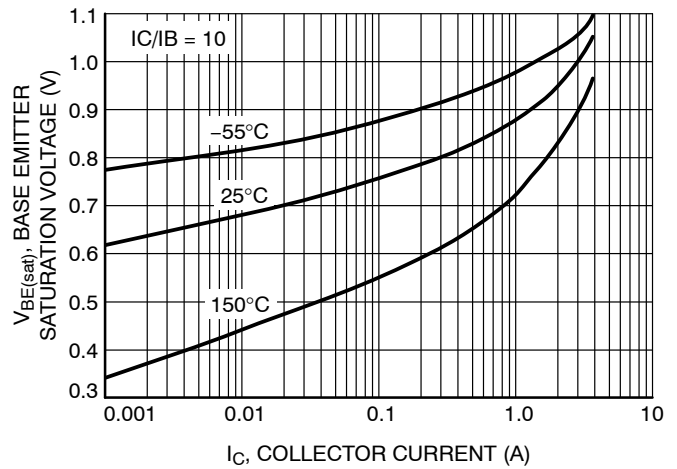

Figure 18. Base Emitter Saturation Voltage vs. Collector Current

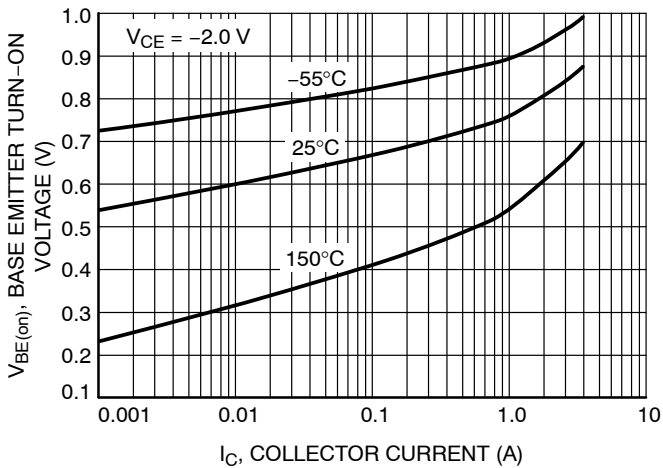

Figure 19. Base Emitter Turn-On Voltage vs. Collector Current

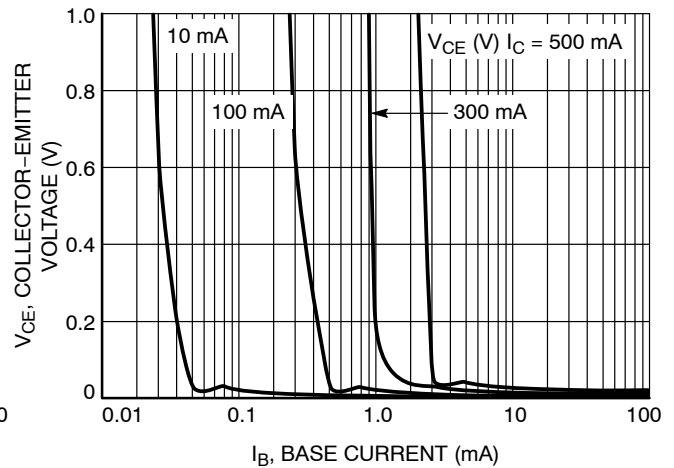

Figure 20. Saturation Region

NUS6189MN

TYPICAL CHARACTERISTICS – SINGLE PNP TRANSISTOR (BJT – CHARGING)

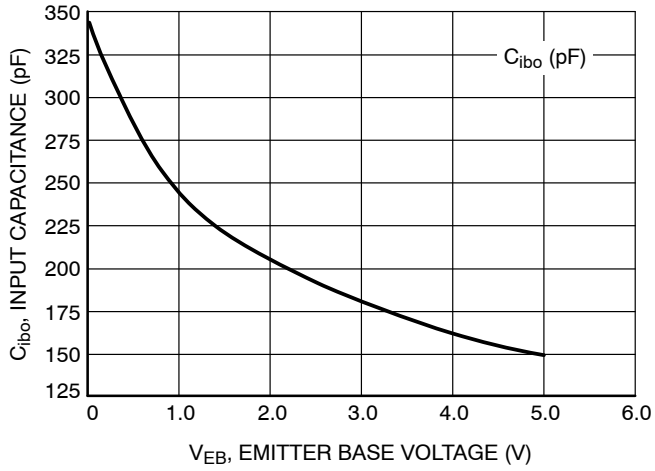

Figure 21. Input Capacitance

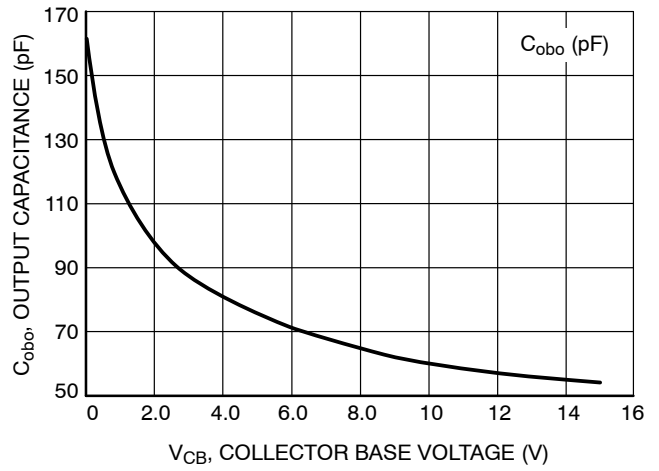

Figure 22. Output Capacitance

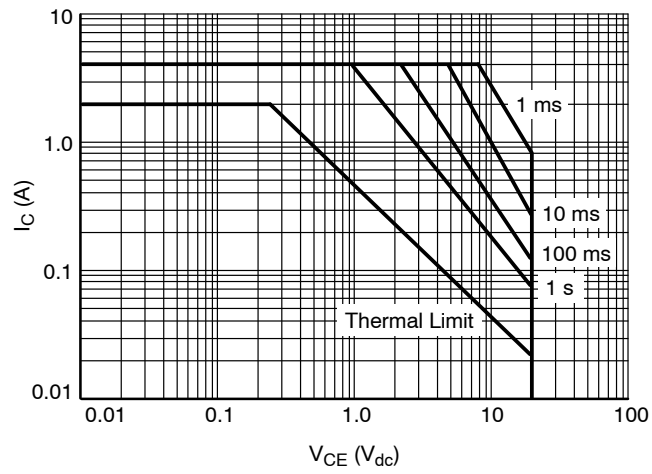

Figure 23. Safe Operating Area

NUS6189MN

TYPICAL PERFORMANCE CURVES – OVERVOLTAGE PROTECTION IC

($T_A = 25^\circ\text{C}$, unless otherwise specified)

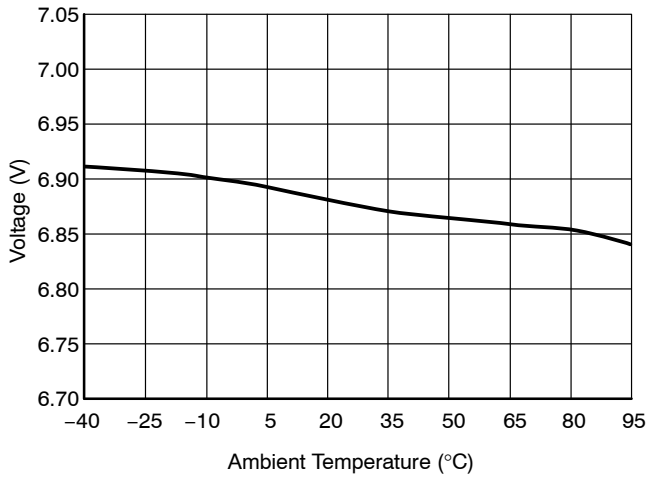

Figure 24. Typical V_{th} Threshold Variation vs. Temperature

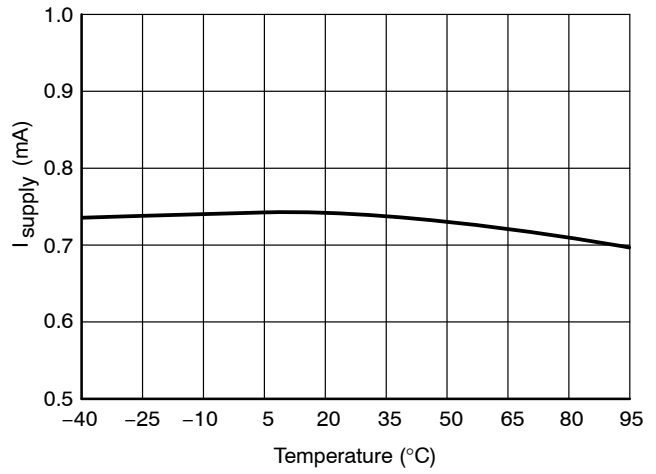

Figure 25. Typical Supply Current vs. Temperature
 $I_{CC} + I_{in}$, $V_{CC} = 6\text{ V}$

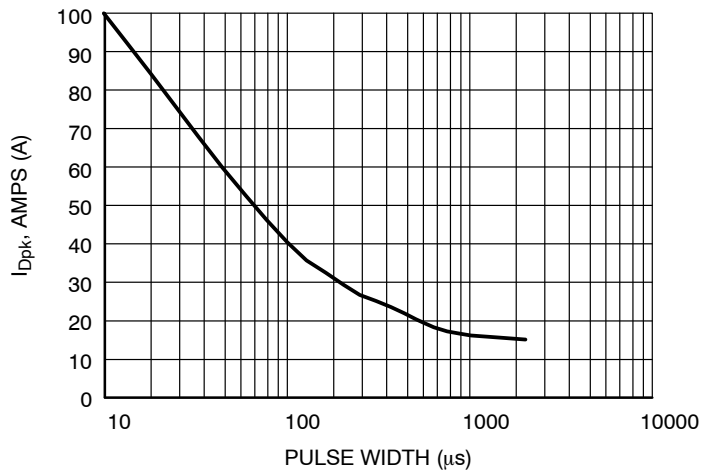

Figure 26. Typical Maximum Drain Peak Current vs Pulse Width
 (Non-repetitive Single Pulse, $V_{GS} = 10\text{ V}$, $T_A = 25^\circ\text{C}$)

NUS6189MN

TYPICAL PERFORMANCE CURVES – 30V, P–CHANNEL MOSFET (MOSFET2 – OVP)

($T_A = 25^\circ\text{C}$, unless otherwise specified)

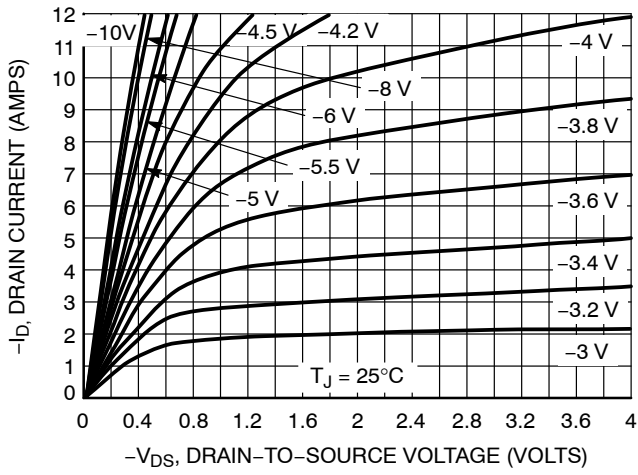

Figure 27. On-Region Characteristics

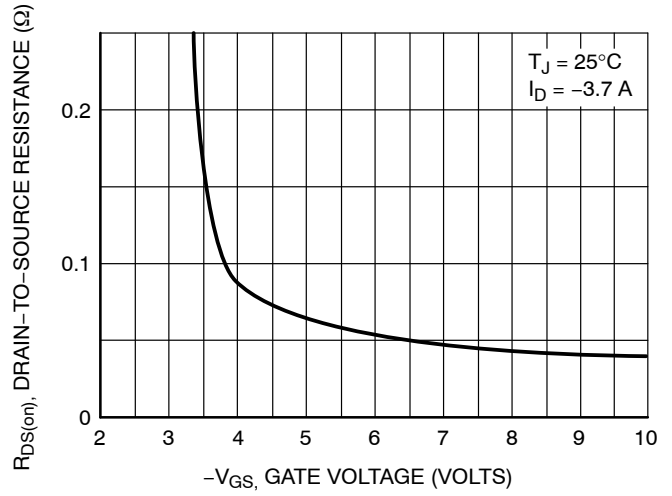

Figure 28. On-Resistance vs. Gate-to-Source Voltage

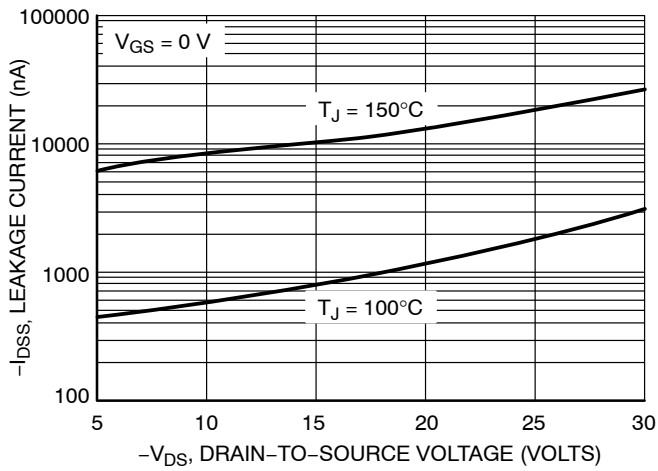

Figure 29. Drain-to-Source Leakage Current vs. Voltage

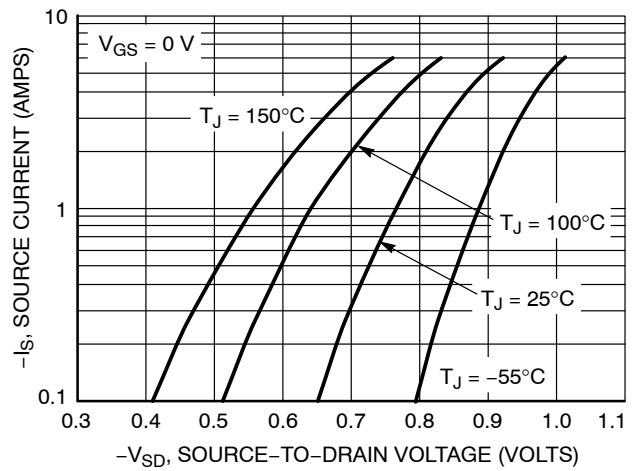
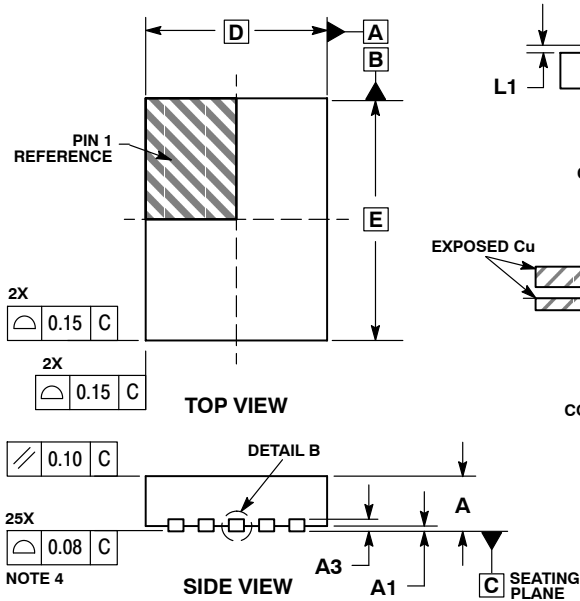

Figure 30. Diode Forward Voltage vs. Current

NUS6189MN

PACKAGE DIMENSIONS

QFN22, 3x4, 0.5P
CASE 485AT-01
ISSUE B



- NOTES:
1. DIMENSIONING AND TOLERANCING PER ASME Y14.5M, 1994.
 2. CONTROLLING DIMENSION: MILLIMETERS.
 3. DIMENSION b APPLIES TO PLATED TERMINAL AND IS MEASURED BETWEEN 0.15 AND 0.30 MM FROM TERMINAL TIP.
 4. COPLANARITY APPLIES TO THE EXPOSED PADS AS WELL AS THE TERMINALS.

DIM	MILLIMETERS		
	MIN	NOM	MAX
A	0.80	0.90	1.00
A1	0.00	0.025	0.05
A3	0.20 REF		
b	0.20	0.25	0.30
D	3.00 BSC		
D2	1.45	1.50	1.55
D3	0.52	0.57	0.62
D4	1.02	1.07	1.12
E	4.00 BSC		
E2	1.05	1.10	1.15
E3	1.30	1.35	1.40
E4	1.40	1.45	1.50
e	0.50 BSC		
K	0.25	---	---
L	0.30	0.325	0.35
L1	---	---	0.15
G	1.35	1.40	1.50
G1	0.95	1.05	1.15
G2	0.855	0.885	0.915

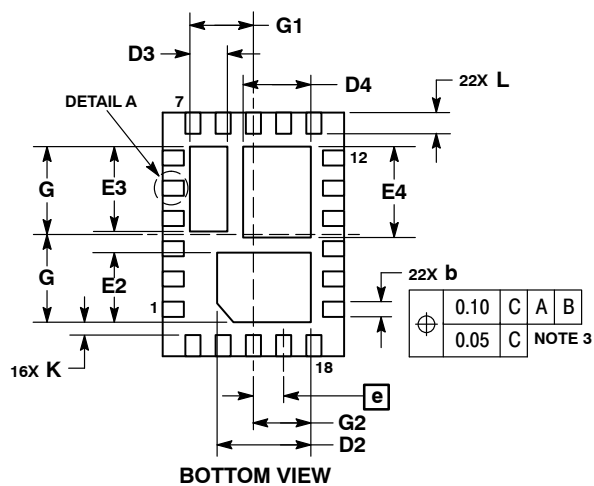

SOLDERING FOOTPRINT*

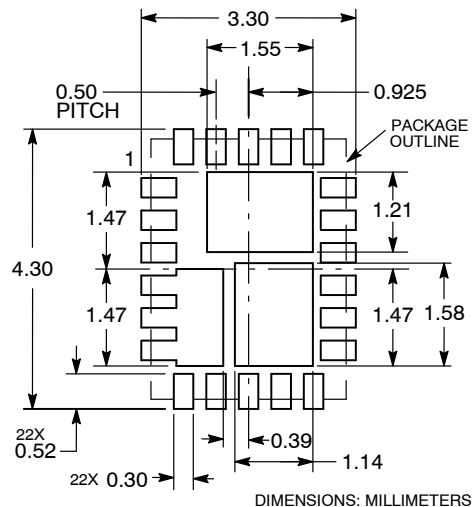

ON Semiconductor and are registered trademarks of Semiconductor Components Industries, LLC (SCILLC). SCILLC reserves the right to make changes without further notice to any products herein. SCILLC makes no warranty, representation or guarantee regarding the suitability of its products for any particular purpose, nor does SCILLC assume any liability arising out of the application or use of any product or circuit, and specifically disclaims any and all liability, including without limitation special, consequential or incidental damages. "Typical" parameters which may be provided in SCILLC data sheets and/or specifications can and do vary in different applications and actual performance may vary over time. All operating parameters, including "Typicals" must be validated for each customer application by customer's technical experts. SCILLC does not convey any license under its patent rights nor the rights of others. SCILLC products are not designed, intended, or authorized for use as components in systems intended for surgical implant into the body, or other applications intended to support or sustain life, or for any other application in which the failure of the SCILLC product could create a situation where personal injury or death may occur. Should Buyer purchase or use SCILLC products for any such unintended or unauthorized application, Buyer shall indemnify and hold SCILLC and its officers, employees, subsidiaries, affiliates, and distributors harmless against all claims, costs, damages, and expenses, and reasonable attorney fees arising out of, directly or indirectly, any claim of personal injury or death associated with such unintended or unauthorized use, even if such claim alleges that SCILLC was negligent regarding the design or manufacture of the part. SCILLC is an Equal Opportunity/Affirmative Action Employer. This literature is subject to all applicable copyright laws and is not for resale in any manner.

PUBLICATION ORDERING INFORMATION

LITERATURE FULFILLMENT:
Literature Distribution Center for ON Semiconductor
P.O. Box 5163, Denver, Colorado 80217 USA
Phone: 303-675-2175 or 800-344-3860 Toll Free USA/Canada
Fax: 303-675-2176 or 800-344-3867 Toll Free USA/Canada
Email: orderlit@onsemi.com

N. American Technical Support: 800-282-9855 Toll Free
USA/Canada
Europe, Middle East and Africa Technical Support:
Phone: 421 33 790 2910
Japan Customer Focus Center
Phone: 81-3-5773-3850

ON Semiconductor Website: www.onsemi.com
Order Literature: <http://www.onsemi.com/orderlit>

For additional information, please contact your local Sales Representative