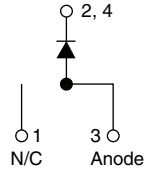

## Hyperfast Rectifier, 6 A FRED Pt<sup>®</sup>

**DPAK (TO-252AA)**

### FEATURES

- Hyperfast recovery time, extremely low  $Q_{rr}$
- 175 °C maximum operating junction temperature
- For PFC CCM operation
- Low forward voltage drop
- Low leakage current
- AEC-Q101 qualified
- Meets JESD 201 class 2 whisker test
- Meets MSL level 1, per J-STD-020, LF maximum peak of 260 °C
- Material categorization: for definitions of compliance please see [www.vishay.com/doc?99912](http://www.vishay.com/doc?99912)

**RoHS**  
 COMPLIANT  
 HALOGEN  
**FREE**

| PRIMARY CHARACTERISTICS |                 |
|-------------------------|-----------------|
| $I_{F(AV)}$             | 6 A             |
| $V_R$                   | 600 V           |
| $V_F$ at $I_F$          | 1.65 V          |
| $t_{rr}$ (typ.)         | 14 ns           |
| $T_J$ max.              | 175 °C          |
| Package                 | DPAK (TO-252AA) |
| Circuit configuration   | Single          |

### DESCRIPTION / APPLICATIONS

State of the art hyperfast recovery rectifiers designed with optimized performance of forward voltage drop, hyperfast recovery time, and soft recovery.

The planar structure and the platinum doped life time control guarantee the best overall performance, ruggedness and reliability characteristics.

These devices are intended for use in PFC boost stage in the AC/DC section of SMPS inverters or as freewheeling diodes. Their extremely optimized stored charge and low recovery current minimize the switching losses and reduce over dissipation in the switching element and snubbers.

| ABSOLUTE MAXIMUM RATINGS                    |                |  |             |       |
|---|----------------|--|-------------|-------|
| PARAMETER                                   | SYMBOL         | TEST CONDITIONS                                    | VALUES      | UNITS |
| Peak repetitive reverse voltage             | $V_{RRM}$      |  | 600         | V     |
| Average rectified forward current           | $I_{F(AV)}$    | $T_C = 136\text{ °C}$                              | 6           | A     |
| Non-repetitive peak surge current           | $I_{FSM}$      | $T_J = 25\text{ °C}$                               | 50          |       |
| Peak repetitive forward current             | $I_{FM}$       | $T_C = 136\text{ °C}, f = 20\text{ kHz}, d = 50\%$ | 12          |       |
| Operating junction and storage temperatures | $T_J, T_{Stg}$ |  | -65 to +175 | °C    |

| ELECTRICAL SPECIFICATIONS ( $T_J = 25\text{ °C}$ unless otherwise specified) |               |  |      |      |      |               |
|--|---------------|--|------|------|------|---------------|
| PARAMETER  | SYMBOL        | TEST CONDITIONS                              | MIN. | TYP. | MAX. | UNITS         |
| Breakdown voltage, blocking voltage  | $V_{BR}, V_R$ | $I_R = 100\text{ }\mu\text{A}$               | 600  | -    | -    | V             |
|  |               |  |      |      |      |               |
| Forward voltage  | $V_F$         | $I_F = 6\text{ A}$                           | -    | 2.50 | 3.1  |               |
|  |               | $I_F = 6\text{ A}, T_J = 150\text{ °C}$      | -    | 1.65 | 1.9  |               |
| Reverse leakage current  | $I_R$         | $V_R = V_R$ rated                            | -    | -    | 20   | $\mu\text{A}$ |
|  |               | $T_J = 150\text{ °C}, V_R = V_R$ rated       | -    | -    | 250  |               |
| Junction capacitance   | $C_T$         | $V_R = 600\text{ V}$                         | -    | 3.5  | -    | pF            |
| Series inductance  | $L_S$         | Measured lead to lead 5 mm from package body | -    | 8    | -    | nH            |



| <b>DYNAMIC RECOVERY CHARACTERISTICS</b> ( $T_J = 25\text{ }^\circ\text{C}$ unless otherwise specified) |           |   |      |      |      |       |
|--|-----------|---|------|------|------|-------|
| PARAMETER  | SYMBOL    | TEST CONDITIONS   | MIN. | TYP. | MAX. | UNITS |
| Reverse recovery time  | $t_{rr}$  | $I_F = 1\text{ A}$ , $di_F/dt = 100\text{ A}/\mu\text{s}$ , $V_R = 30\text{ V}$ | -    | 14   | 21   | ns    |
|  |           | $I_F = 1\text{ A}$ , $di_F/dt = 50\text{ A}/\mu\text{s}$ , $V_R = 30\text{ V}$  | -    | 16   | -    |       |
|  |           | $T_J = 25\text{ }^\circ\text{C}$  | -    | 19   | -    |       |
|  |           | $T_J = 125\text{ }^\circ\text{C}$   | -    | 27   | -    |       |
| Peak recovery current  | $I_{RRM}$ | $T_J = 25\text{ }^\circ\text{C}$  | -    | 3.0  | -    | A     |
|  |           | $T_J = 125\text{ }^\circ\text{C}$   | -    | 4.0  | -    |       |
| Reverse recovery charge  | $Q_{rr}$  | $T_J = 25\text{ }^\circ\text{C}$  | -    | 28   | -    | nC    |
|  |           | $T_J = 125\text{ }^\circ\text{C}$   | -    | 57   | -    |       |

| <b>THERMAL - MECHANICAL SPECIFICATIONS</b>     |                |                            |           |      |      |                           |
|--|----------------|----------------------------|-----------|------|------|---------------------------|
| PARAMETER                                      | SYMBOL         | TEST CONDITIONS            | MIN.      | TYP. | MAX. | UNITS                     |
| Maximum junction and storage temperature range | $T_J, T_{Stg}$ |                            | -65       | -    | 175  | $^\circ\text{C}$          |
| Thermal resistance, junction to case per leg   | $R_{thJC}$     |                            | -         | -    | 3    | $^\circ\text{C}/\text{W}$ |
| Approximate weight                             |                |                            | 0.3       |      |      | g                         |
|  |                |                            | 0.01      |      |      | oz.                       |
| Marking device                                 |                | Case style DPAK (TO-252AA) | 6EWX06FNH |      |      |                           |

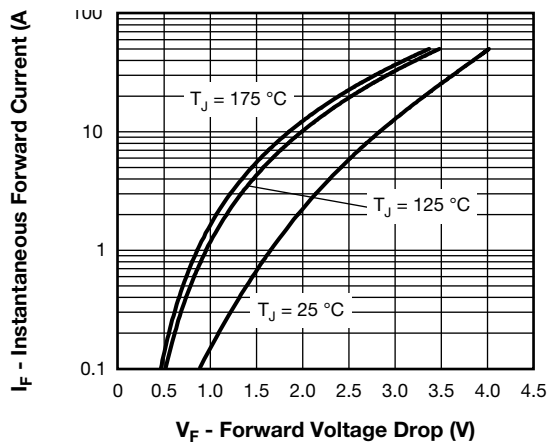

Fig. 1 - Typical Forward Voltage Drop Characteristics

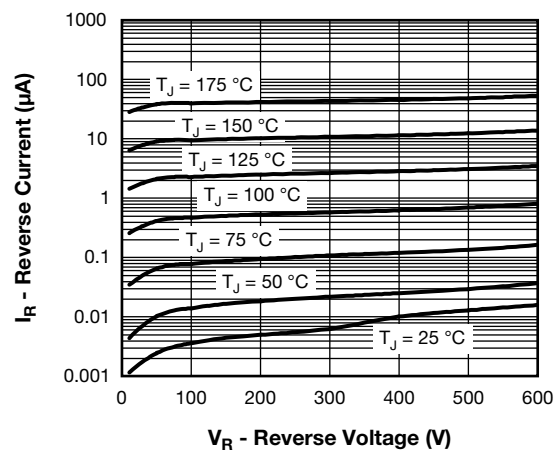

Fig. 2 - Typical Values of Reverse Current vs. Reverse Voltage

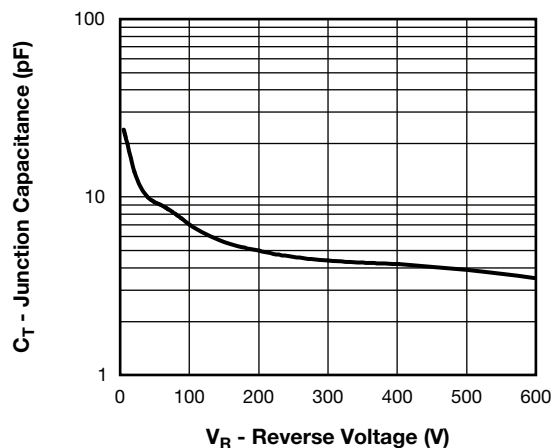

Fig. 3 - Typical Junction Capacitance vs. Reverse Voltage

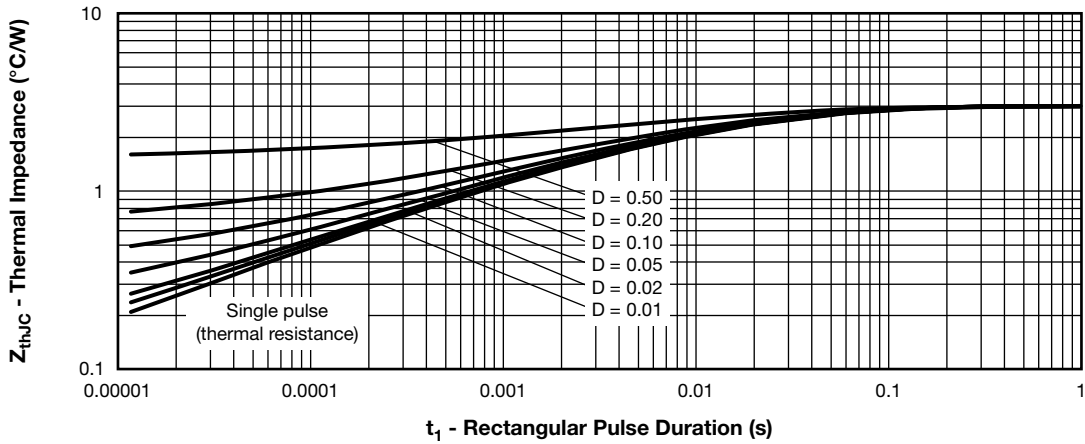

Fig. 4 - Maximum Thermal Impedance  $Z_{thJC}$  Characteristics

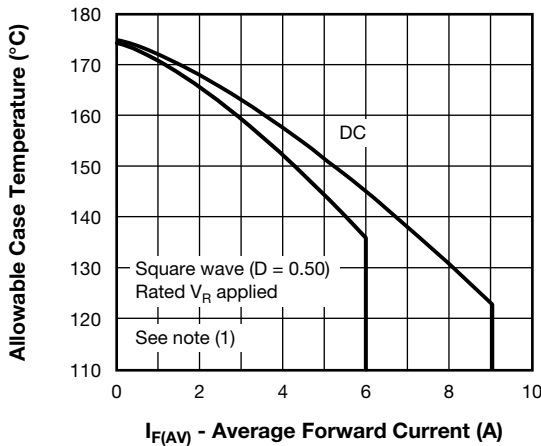

Fig. 5 - Maximum Allowable Case Temperature vs. Average Forward Current

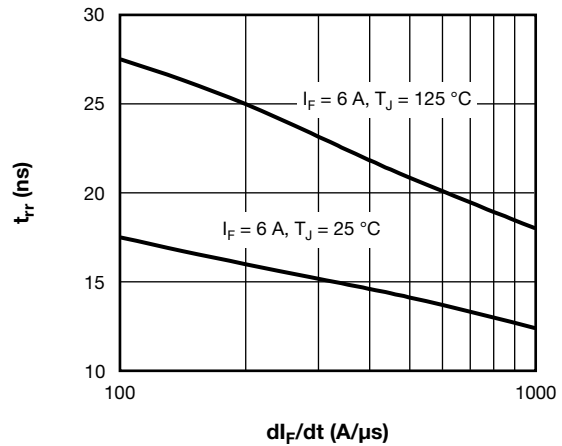

Fig. 7 - Typical Reverse Recovery Time vs.  $di/dt$

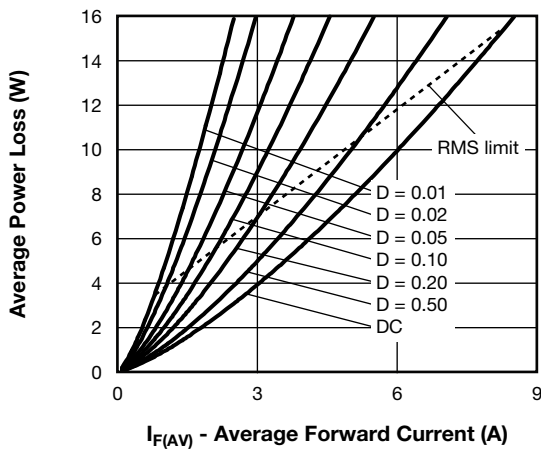

Fig. 6 - Forward Power Loss Characteristics

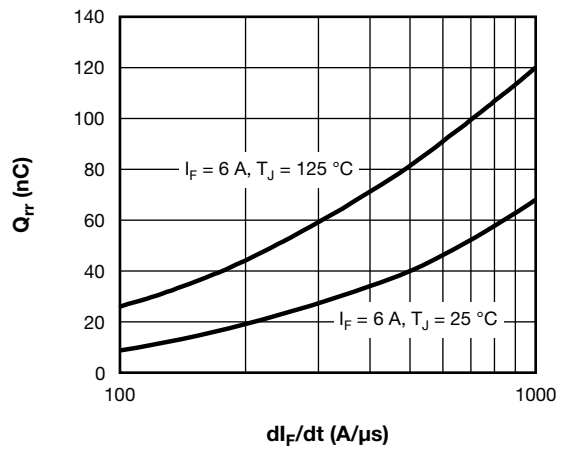

Fig. 8 - Typical Stored Charge vs.  $di/dt$

**Note**

- (1) Formula used:  $T_C = T_J - (P_d + P_{dREV}) \times R_{thJC}$ ;
- $P_d$  = forward power loss =  $I_{F(AV)} \times V_{FM}$  at  $(I_{F(AV)}/D)$  (see fig. 6);
- $P_{dREV}$  = inverse power loss =  $V_{R1} \times I_R (1 - D)$ ;  $I_R$  at  $V_{R1}$  = rated  $V_R$

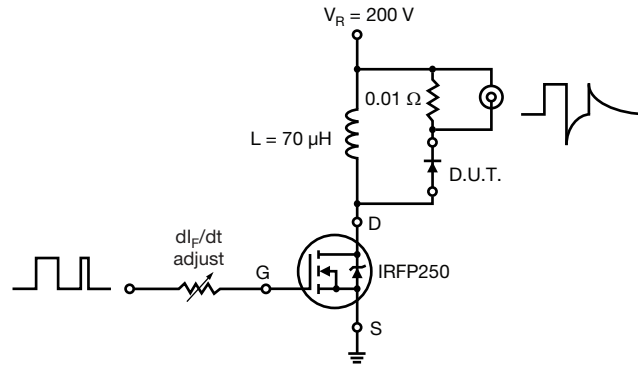
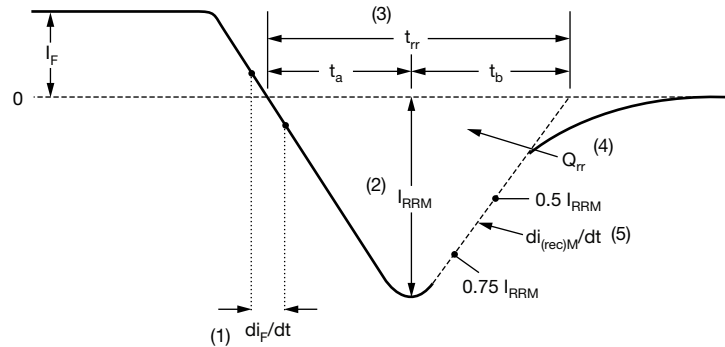

Fig. 9 - Reverse Recovery Parameter Test Circuit



- (1)  $di_F/dt$  - rate of change of current through zero crossing
- (2)  $I_{RRM}$  - peak reverse recovery current
- (3)  $t_{rr}$  - reverse recovery time measured from zero crossing point of negative going  $I_F$  to point where a line passing through  $0.75 I_{RRM}$  and  $0.50 I_{RRM}$  extrapolated to zero current.
- (4)  $Q_{rr}$  - area under curve defined by  $t_{rr}$  and  $I_{RRM}$
- (5)  $di_{(rec)M}/dt$  - peak rate of change of current during  $t_b$  portion of  $t_{rr}$

$$Q_{rr} = \frac{t_{rr} \times I_{RRM}}{2}$$

Fig. 10 - Reverse Recovery Waveform and Definitions



## ORDERING INFORMATION TABLE

|             |            |          |          |          |          |           |           |            |          |           |
|-------------|------------|----------|----------|----------|----------|-----------|-----------|------------|----------|-----------|
| Device code | <b>VS-</b> | <b>6</b> | <b>E</b> | <b>W</b> | <b>X</b> | <b>06</b> | <b>FN</b> | <b>TRL</b> | <b>H</b> | <b>M3</b> |
|             | ①          | ②        | ③        | ④        | ⑤        | ⑥         | ⑦         | ⑧          | ⑨        | ⑩         |

- 1** - Vishay Semiconductors product
- 2** - Current rating (6 = 6 A)
- 3** - Circuit configuration:  
E = single diode
- 4** - Package identifier:  
W = D-PAK
- 5** - X = hyperfast recovery time
- 6** - Voltage rating (06 = 600 V)
- 7** - FN = TO-252AA
- 8** -
  - None = tube
  - TR = tape and reel
  - TRL = tape and reel (left oriented)
  - TRR = tape and reel (right oriented)
- 9** - H = AEC-Q101 qualified
- 10** - Environmental digit:  
M3 = halogen-free, RoHS-compliant, and terminations lead (Pb)-free

| <b>ORDERING INFORMATION</b> (Example) |                      |                              |
|---------------------------------------|----------------------|------------------------------|
| <b>PREFERRED P/N</b>                  | <b>BASE QUANTITY</b> | <b>PACKAGING DESCRIPTION</b> |
| VS-6EWX06FNHM3                        | 75                   | Antistatic plastic tube      |
| VS-6EWX06FNTRHM3                      | 2000                 | 13" diameter reel            |
| VS-6EWX06FNTRRHM3                     | 3000                 | 13" diameter reel            |
| VS-6EWX06FNTRLHM3                     | 3000                 | 13" diameter reel            |

| <b>LINKS TO RELATED DOCUMENTS</b> |  |
|-----------------------------------|--|
| Dimensions                        | <a href="http://www.vishay.com/doc?95519">www.vishay.com/doc?95519</a> |
| Part marking information          | <a href="http://www.vishay.com/doc?95518">www.vishay.com/doc?95518</a> |
| Packaging information             | <a href="http://www.vishay.com/doc?95033">www.vishay.com/doc?95033</a> |

### DPAK (TO-252AA)

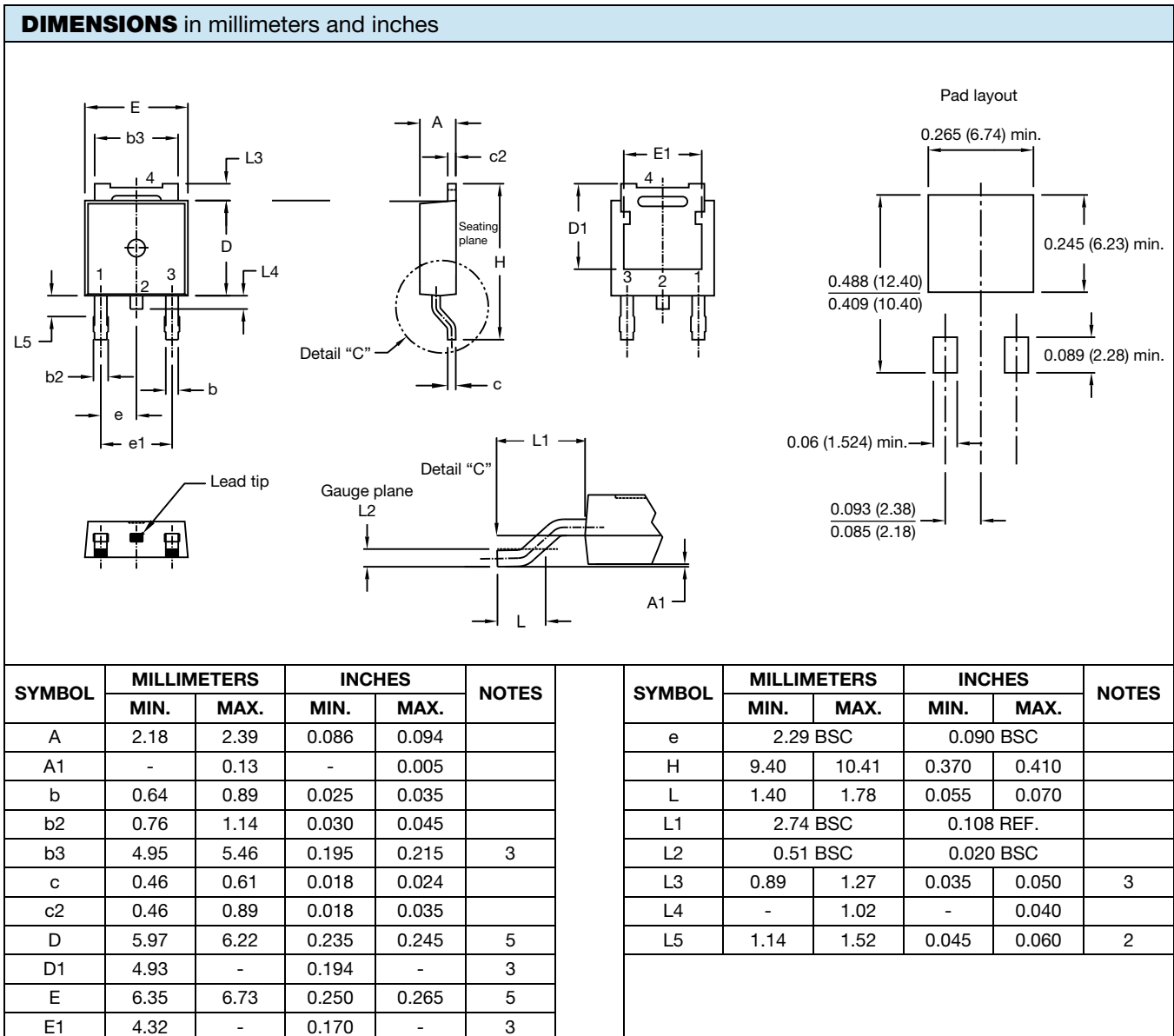

**Notes**

- (1) Dimensioning and tolerancing as per ASME Y14.5M-1994
- (2) Lead dimension uncontrolled in L5
- (3) Dimension D1, E1, L3 and b3 establish a minimum mounting surface for thermal pad
- (4) Dimensions D and E do not include mold flash. Mold flash shall not exceed 0.127 mm (0.005") per side. These dimensions are measured at the outermost extremes of the plastic body
- (5) Outline conforms to JEDEC® outline TO-252AA, except for D1 dimension



## **Disclaimer**

ALL PRODUCT, PRODUCT SPECIFICATIONS AND DATA ARE SUBJECT TO CHANGE WITHOUT NOTICE TO IMPROVE RELIABILITY, FUNCTION OR DESIGN OR OTHERWISE.

Vishay Intertechnology, Inc., its affiliates, agents, and employees, and all persons acting on its or their behalf (collectively, "Vishay"), disclaim any and all liability for any errors, inaccuracies or incompleteness contained in any datasheet or in any other disclosure relating to any product.

Vishay makes no warranty, representation or guarantee regarding the suitability of the products for any particular purpose or the continuing production of any product. To the maximum extent permitted by applicable law, Vishay disclaims (i) any and all liability arising out of the application or use of any product, (ii) any and all liability, including without limitation special, consequential or incidental damages, and (iii) any and all implied warranties, including warranties of fitness for particular purpose, non-infringement and merchantability.

Statements regarding the suitability of products for certain types of applications are based on Vishay's knowledge of typical requirements that are often placed on Vishay products in generic applications. Such statements are not binding statements about the suitability of products for a particular application. It is the customer's responsibility to validate that a particular product with the properties described in the product specification is suitable for use in a particular application. Parameters provided in datasheets and / or specifications may vary in different applications and performance may vary over time. All operating parameters, including typical parameters, must be validated for each customer application by the customer's technical experts. Product specifications do not expand or otherwise modify Vishay's terms and conditions of purchase, including but not limited to the warranty expressed therein.

Hyperlinks included in this datasheet may direct users to third-party websites. These links are provided as a convenience and for informational purposes only. Inclusion of these hyperlinks does not constitute an endorsement or an approval by Vishay of any of the products, services or opinions of the corporation, organization or individual associated with the third-party website. Vishay disclaims any and all liability and bears no responsibility for the accuracy, legality or content of the third-party website or for that of subsequent links.

Except as expressly indicated in writing, Vishay products are not designed for use in medical, life-saving, or life-sustaining applications or for any other application in which the failure of the Vishay product could result in personal injury or death. Customers using or selling Vishay products not expressly indicated for use in such applications do so at their own risk. Please contact authorized Vishay personnel to obtain written terms and conditions regarding products designed for such applications.

No license, express or implied, by estoppel or otherwise, to any intellectual property rights is granted by this document or by any conduct of Vishay. Product names and markings noted herein may be trademarks of their respective owners.