

High Power White LEDs

SST-70X-WxS

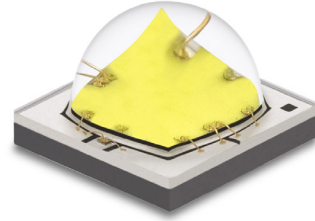

Table of Contents

Ordering Part Numbers	2
Binning Information	3
Chromaticity Binning Structure	4
Product Characteristics	6
Soldering Profile	9
Precautions for Use	10
Mechanical Dimensions	11
Tape and Reel	12
Packaging and Labeling	13

Features

- 6V or 12V configurable, excellent color and brightness uniformity from a multi-junction single monolithic emitter.
- High brightness cool white LEDs with maximum output in excess of 3300 lm @ 5.25 A (6V), 85°C.
- High lumen density up to 500 lm/mm², ideal for maximizing the optical efficiency in high-output, beam pattern critical lighting applications.
- Maximum Drive Current: 5.25 A (6V), 2.625 A (12V)
- Luminous Efficacy: typ. 164 lm/W @ 700 mA, 85°C
- Color Temperature: 6500K
- Color Rendering Index: min. 65, typ. 70
- Low thermal resistance: 0.6° C/W
- ANSI-compatible chromaticity bins
- Electrically isolated thermal path
- 8 kV HBM ESD rating per ANSI/ESDA/JEDEC JS-001
- RoHS and REACH compliant

Applications

- | | |
|-----------------------------------|--------------------------------|
| • Portable Lights | • LED Work Lights |
| • Automotive Auxiliary Lights | • Outdoor and Roadway Lighting |
| • Battery or Solar Powered Lights | • High Bay Industrial Lighting |

Ordering Part Numbers

CCT	Minimum Flux Bin ¹	Minimum Flux (lm)	Chromaticity Bin Kit Code ²	Ordering Part Numbers
6500K	LA	1200	651	SST-70X-WCS-H50-LA651
			652	SST-70X-WCS-H50-LA652
	LB	1290	651	SST-70X-WCS-H50-LB651
			652	SST-70X-WCS-H50-LB652

Notes

1. The Ordering Part Number specifies the Minimum Flux Bin in shipment; higher flux bins may be shipped without advance notice. Please refer to 'Luminous Flux Binning' table for details of all flux bins.
2. Shipments always adhere to the color bins specified in each Chromaticity Bin Kit. See 'Chromaticity Bin Kit Codes' table for the color bins included in each Bin Kit.

Part Number Nomenclature

SST — 70X — W<xy> — H50 — <ffccc>

Product Family	Light Emission Area	Light Color	Package Configuration	Bin Kit
S: Surface Mount S: Dome Lensed T: Single Emitter	70: 7.0 mm ² X: Multi-Junction	W: White <x> Color Temperature C: Cool White <y> CRI Category Code S: CRI>65	H50: Package Code	<ff> Minimum Flux Bin, see 'Luminus Flux Binning' table for details <ccc> Chromaticity Bin Kit, see 'Chromaticity Bin Kit Codes' table for details

Luminous Flux Binning

Flux Bin Code	Binning @ 1500 mA(6V), T _j =85°C ¹		@ 700 mA, T _j =25°C ²	Correlated Minimum Flux (lm) @ T _j =85°C ²				
	Minimum Flux (lm)	Maximum Flux (lm)	Minimum Flux (lm)	700 mA	2000 mA	3000 mA	4000 mA	5250 mA
KA	1042	1120	595	531	1323	1834	2272	2730
KB	1120	1200	640	571	1422	1971	2442	2934
LA	1200	1290	685	612	1524	2112	2616	3144
LB	1290	1380	737	658	1638	2270	2812	3380
MA	1380	1485	788	704	1753	2429	3008	3616

Notes

- LEDs are measured at 25°C ambient temperature with 1500 mA, 6V, 20ms single pulse. The measured values are correlated to 1500 mA, 6V, at 85°C junction temperature (T_j). Luminus maintains a ±6% tolerance on flux measurement.
- Flux values at other junction temperature (T_j) and/or forward current conditions are calculated and for reference only.

Chromaticity Binning Coordinates

CCT	Bin Code	CIE _x	CIE _y	Bin Code	CIE _x	CIE _y	Bin Code	CIE _x	CIE _y	Bin Code	CIE _x	CIE _y
6500K	BA	0.3048	0.3207	BB	0.3028	0.3304	BC	0.3115	0.3391	BD	0.313	0.329
		0.313	0.329		0.3115	0.3391		0.3205	0.3481		0.3213	0.3373
		0.3144	0.3186		0.313	0.329		0.3213	0.3373		0.3221	0.3261
		0.3068	0.3113		0.3048	0.3207		0.313	0.329		0.3144	0.3186
	BH	0.3068	0.3113	BE	0.3005	0.3415	BF	0.3099	0.3509	BG	0.3144	0.3186
		0.3144	0.3186		0.3099	0.3509		0.3196	0.3602		0.3221	0.3261
		0.3161	0.3059		0.3115	0.3391		0.3205	0.3481		0.3231	0.312
		0.3093	0.2993		0.3028	0.3304		0.3115	0.3391		0.3161	0.3059

Chromaticity Binning Diagram

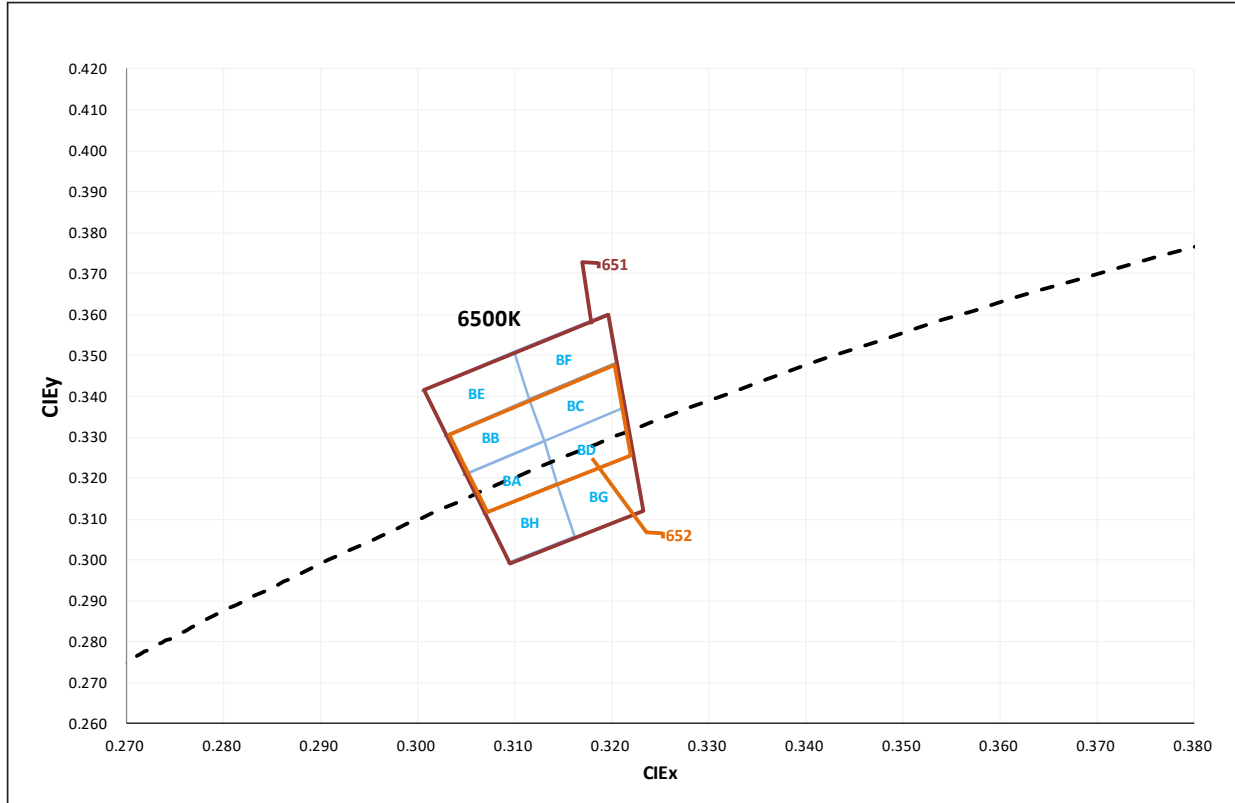

Chromaticity Bin Kit Codes

CCT	Bin Kit	Chromaticity Bins
6500K	651	BA, BB, BC, BD, BE, BF, BG, BH
	652	BA, BB, BC, BD

Note: Luminus maintains a tolerance of ± 0.005 on chromaticity (CIE_x, CIE_y), and ± 2 on Color Rendering Index (CRI) measurements.

Product Characteristics

Parameter	Symbol	Minimum	Typical	Maximum	Unit
Viewing Angle (FWHM)	$2\theta_{1/2}$		135		Degree
Color Rendering Index	CRI	65	70		
Thermal resistance (Electrical) Junction/Solder Point	$R_{thjs-EL}$		0.6		°C/W
Junction Temperature	T_j			150	°C
Forward Voltage (6V, @ $I_f=1500$ mA, $T_j=85^\circ\text{C}$)	$V_{f(6V)}$	5.25	5.72	6.25	V
Forward Voltage (12V, @ $I_f=750$ mA, $T_j=85^\circ\text{C}$)	$V_{f(12V)}$	10.5	11.4	12.5	V
DC Forward Current (6V)	$I_{f(6V)}$	0.2		5.25	A
DC Forward Current (12V)	$I_{f(12V)}$	0.1		2.625	A
Surge Current (t <10 ms, Duty Cycle < 10%)	$I_{s-max(6V)}$			8	A
Reverse Voltage ($I_r=10$ mA)	$V_{r(6V)}$			10	V
Power Dissipation	P_d			38	W
Operating Temperature	T_{opr}	-40		100	°C
Storage Temperature	T_{stg}	-40		100	°C
ESD withstand Voltage HBM Per ANSI/ESDA/JEDEC JS-001	V_{HBM}	8			kV
ESD withstand Voltage CDM Per ANSI/ESDA/JEDEC JS-002	V_{CDM}	1			kV

Optical & Electrical Characteristics

Relative Luminous Flux vs. Forward Current

$\Phi_v/\Phi_v(1.5\text{ A}, 6\text{V}), T_j = 85^\circ\text{C}$

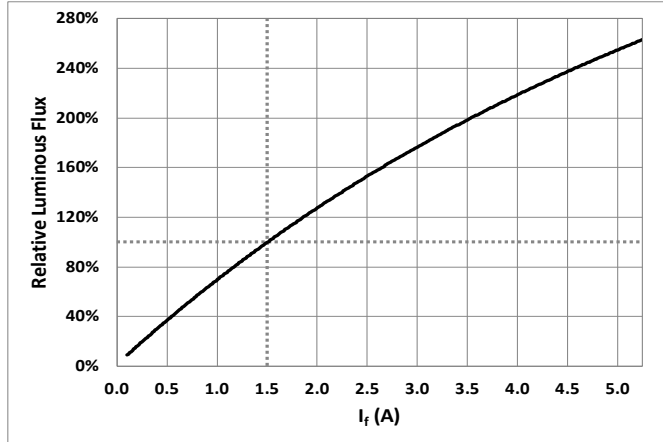

Relative Luminous Flux vs. Temperature (T_j)

$\Phi_v/\Phi_v(85^\circ\text{C}), I_f = 1.5\text{ A} (6\text{V})$

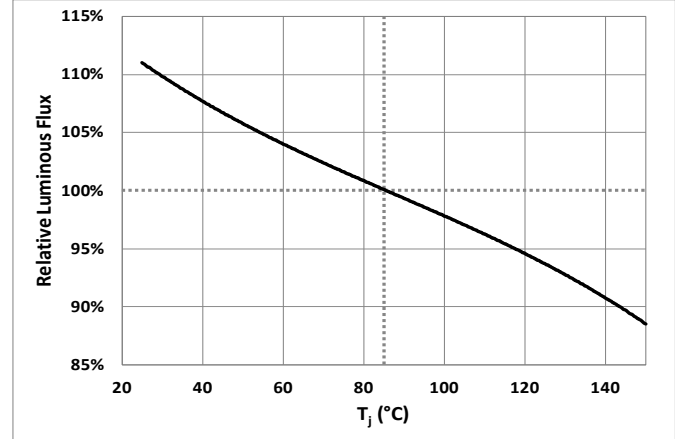

Forward Voltage vs. Forward Current

$V_f = f(I_{f-6V}), T_j = 85^\circ\text{C}$

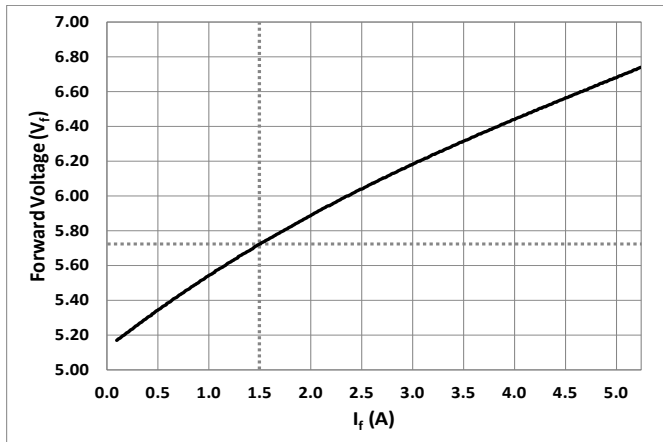

Relative Forward Voltage vs. Temperature (T_j)

$\Delta V_f = V_f(T_j) - V_f(85^\circ\text{C}), I_f = 1.5\text{ A} (6\text{V})$

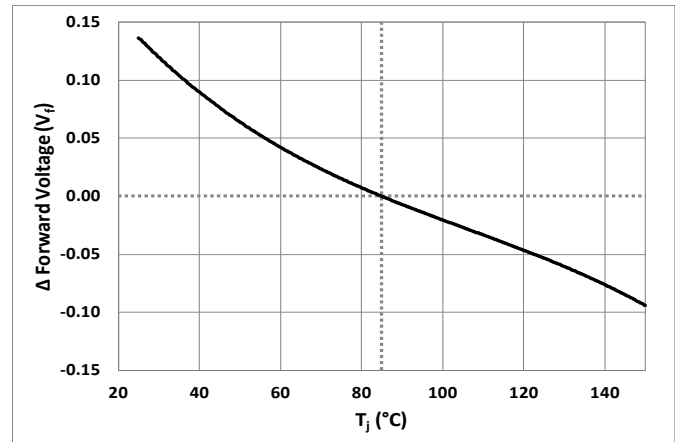

Relative Chromaticity vs. Forward Current

$\Delta CIE_{x,y} = CIE_{x,y}(I_f) - CIE_{x,y}(1.5\text{ A}, 6\text{V}), T_j = 85^\circ\text{C}$

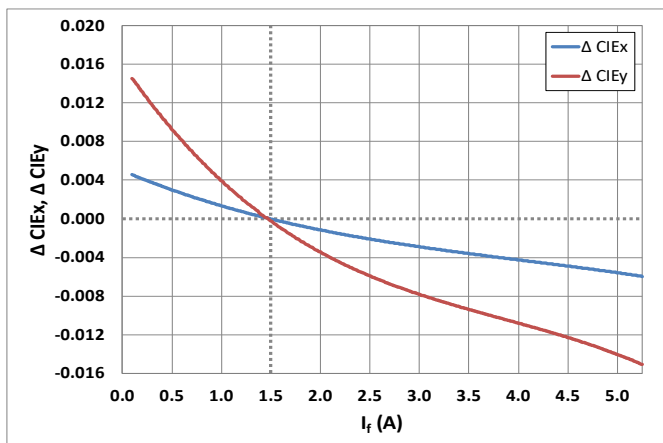

Relative Chromaticity vs. Temperature (T_j)

$\Delta CIE_{x,y} = CIE_{x,y}(T_j) - CIE_{x,y}(85^\circ\text{C}), I_f = 1.5\text{ A} (6\text{V})$

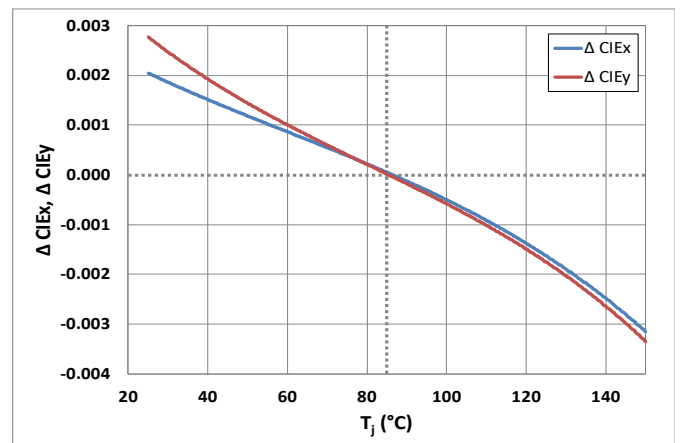

Relative Spectral Power Distribution

$I_f=1.5\text{ A (6V)}, T_j=85^\circ\text{C}$

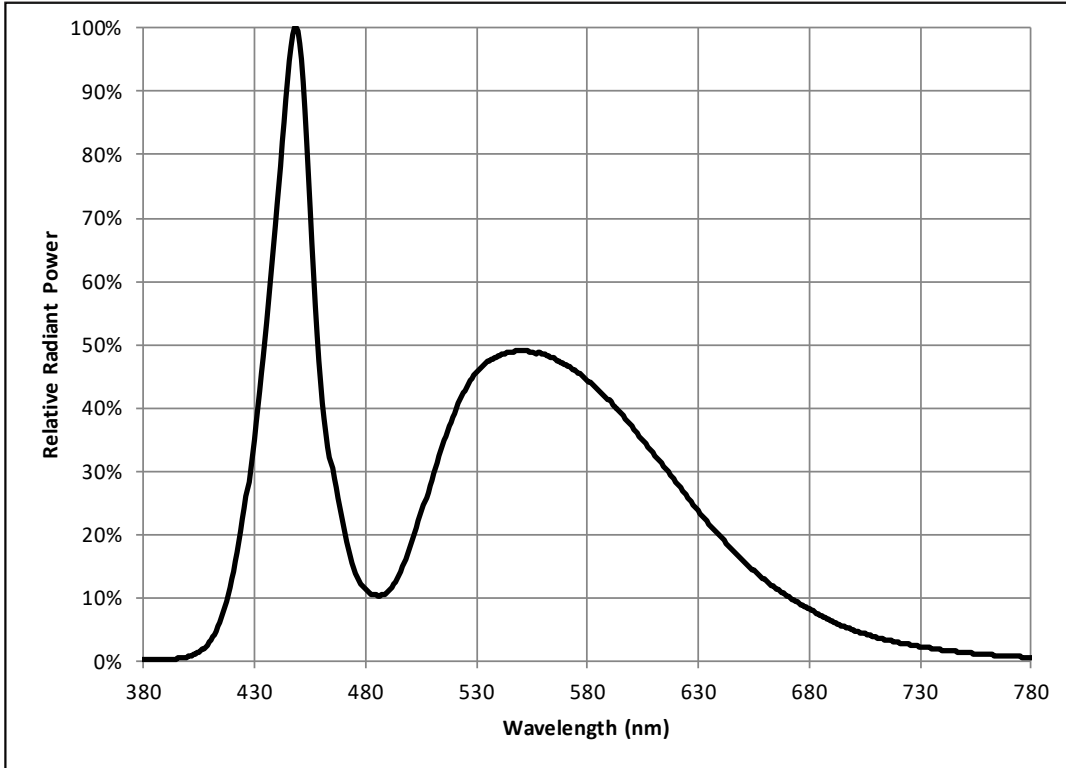

Typical Radiation Characteristics

$I_f=1.5\text{ A (6V)}, T_j=25^\circ\text{C}$

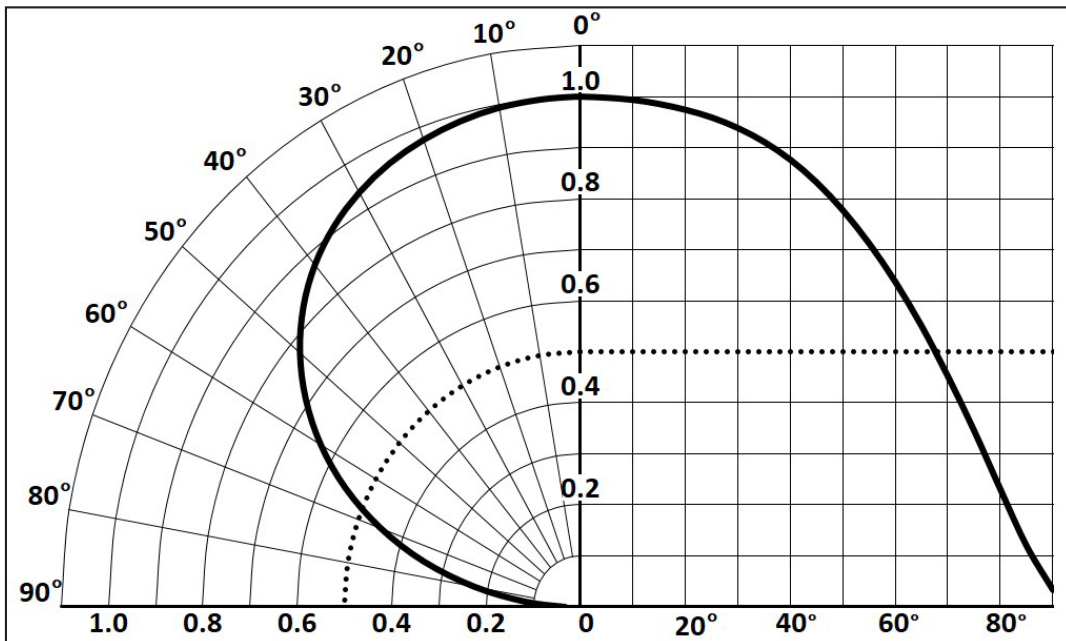

Soldering Profile

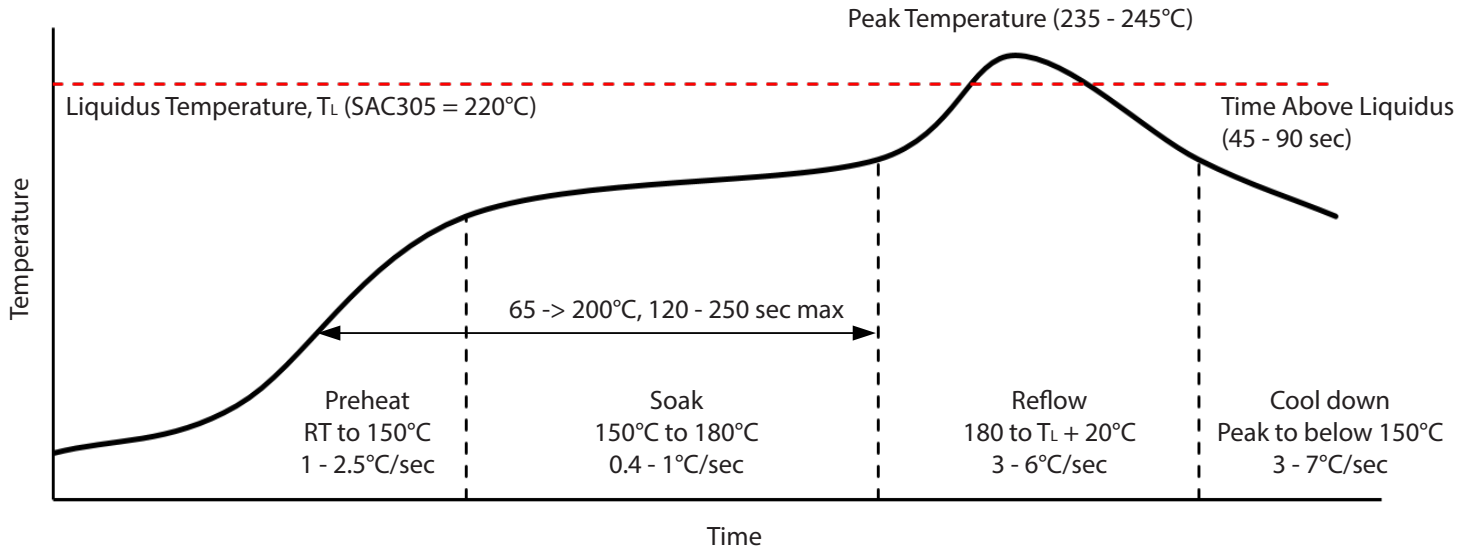

SMT Rework Guideline	Manual Hotplate Reflow	Hot Air Gun Reflow
Heating Time	< 60 sec	
Hotplate Temperature	< 245°C	< 150°C

Notes

- Product complies to Moisture Sensitivity Level 3 (MSL 3).
- The numbers in the table are specific to SAC305. Luminus recommends using an SAC305 solder paste with a no-clean flux for RoHS compliant products.
- During the pick and place process, axial forces on the dome (or window) should not exceed 0.5 Newtons (N).
- Use of a multi-zone IR reflow oven with a nitrogen blanket is recommended.
- Time-temperature profile of the reflow process showing the four functional profile zones are defined in IPC-7801. Temperature is referenced to the center of the PCB.
- Luminus recommends to use the solder paste data sheet information as a starting point in time-temperature process development.
- These are general guidelines. Consult the solder paste manufacturer's datasheet for guidelines specific to the alloy and flux combination used in your application. For more information, please refer to: <https://luminusdevices.zendesk.com/hc/en-us/articles/360060306692-How-do-I-Reflow-Solder-Luminus-SMD-Components->
- For any technical questions about soldering process, please contact Luminus at techsupport@luminus.com.

Precautions for Use

Storage:

1. Before opening the package

The LEDs should be kept at a temperature lower than 40°C and relative humidity lower than 90%. The LEDs should be used within a year. When storing the LEDs, moisture proof package with absorbent material (silica gel) is recommended.

2. After opening the package

The LEDs should be kept at a temperature lower than 30°C and relative humidity lower than 60%. The LEDs should be soldered within 168 hours (7 days) after opening the moisture proof package.

If unused LEDs remain, they should be stored in moisture proof packages, such as sealed containers with moisture absorbent material (silica gel). It is also recommended to return the unused LEDs to the original moisture proof package and to seal it again.

If the moisture absorbent material (silica gel) vaporizes or passes the expiration date, baking treatment should be performed by using the following conditions : 60°C for 20 hours.

The LED's electrode and lead frame comprise a silver plated copper alloy. The silver surface may be affected by environments. Please avoid conditions which may cause the LEDs to corrode or discolor. The corrosion or discoloration might lower solderability or affect optical characteristics.

Please avoid rapid transition in ambient temperature, especially in high humidity environments where condensation can occur.

Static Electricity:

1. The products are sensitive to static electricity, and care should be taken when handling them.

2. Static electricity or surge voltage will damage the LEDs. It is recommended to wear anti-electrostatic gloves or wristband when handling the LEDs.

3. All devices, equipment and machinery must be properly grounded. It is recommended that measures be taken against surge voltage to the equipment that mounts the LEDs.

Package Configuration

Mechanical Dimensions

All dimensions are in millimeter ± 0.13 mm

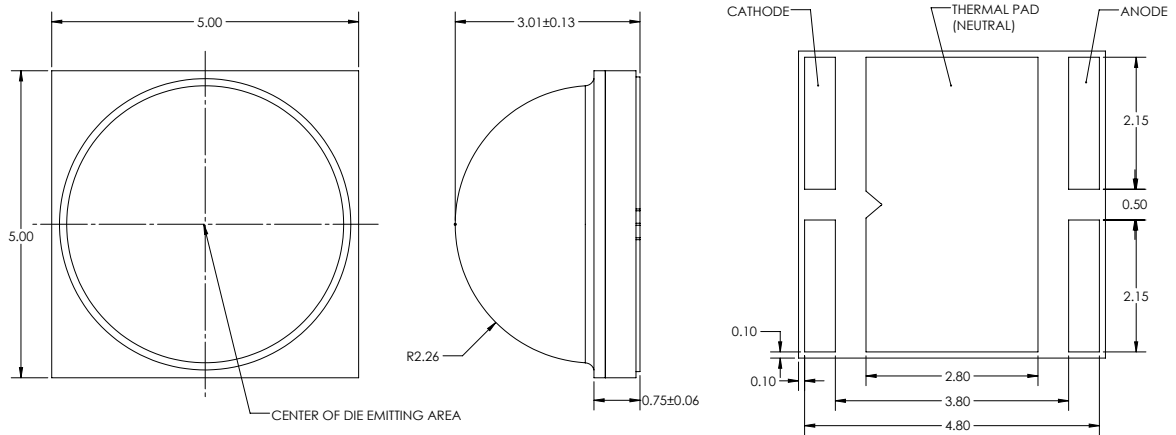

Recommended PCB Solder Pad and Stencil Pattern

All dimensions are in millimeter ± 0.13 mm

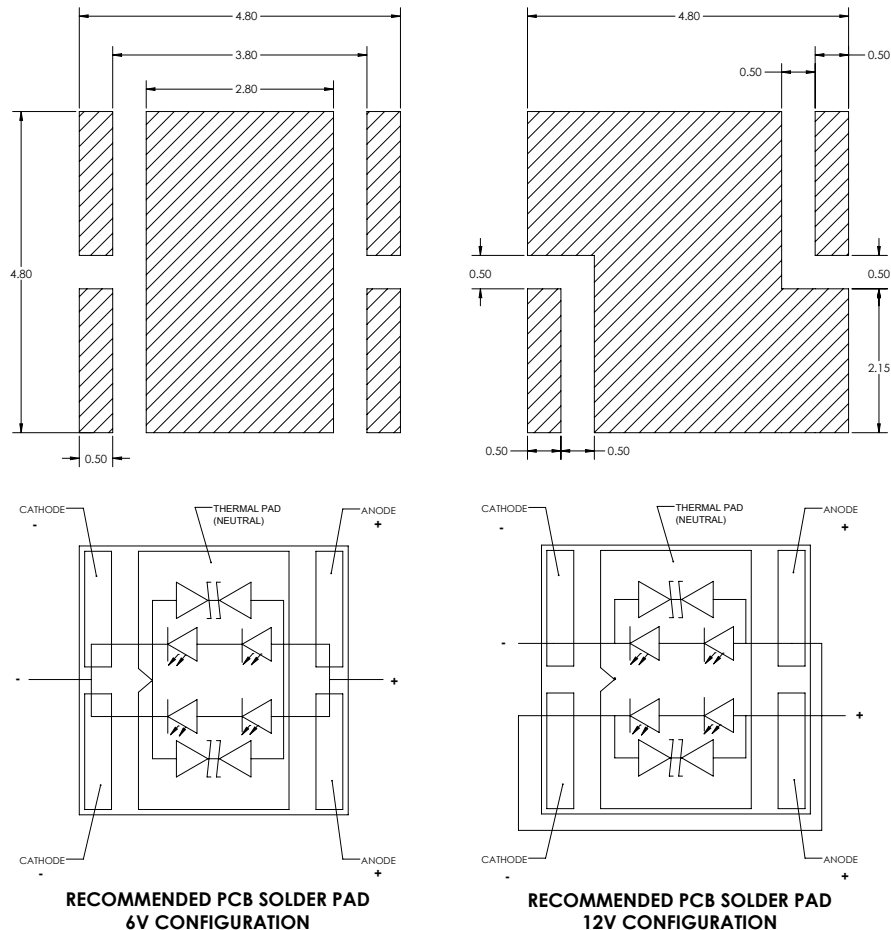

Tape and Reel

All dimensions are in millimeter ± 0.13 mm

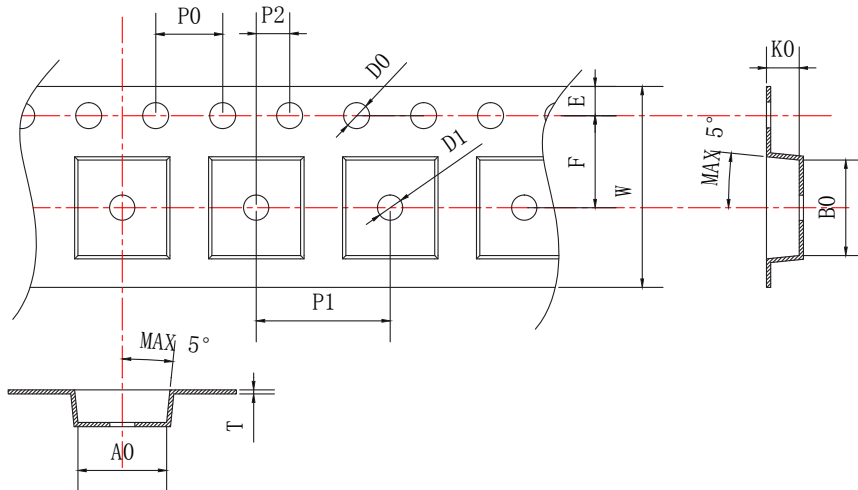

Parameter	Dimension (mm)
A0	5.15 \pm 0.1
B0	5.15 \pm 0.1
D0	1.5+0.1-0.0
D1	1.7 \pm 0.1
E	1.75 \pm 0.1
F	5.5 \pm 0.1
K0	3.0 \pm 0.1
P0	4.0 \pm 0.1
P1	8.0 \pm 0.1
P2	2.0 \pm 0.05
T	0.3 \pm 0.05
W	12 \pm 0.03

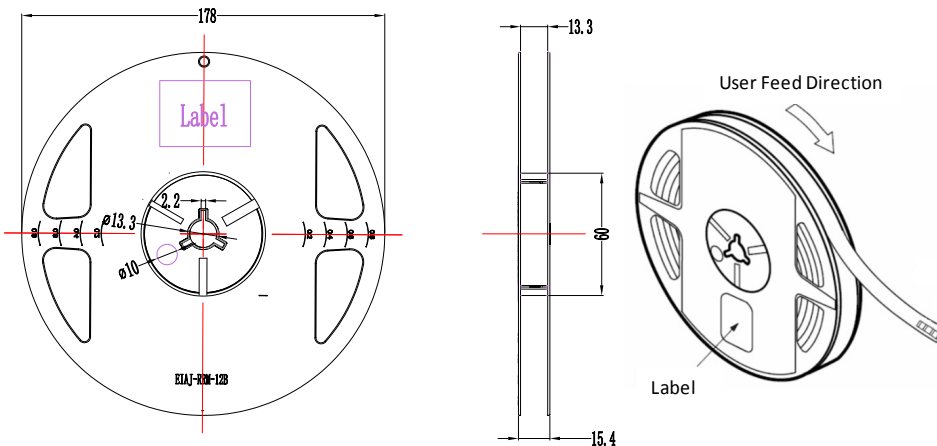

Notes:

1. Each Reel contains 500 units of LEDs.
2. Black anti-static tape material (Denka ECM3/ECAP3)
3. The accumulated tolerance for ten chain holes should be no more than 0.2 mm.
4. The tortuosity of 250 mm tape should be no more than 1 mm.
5. Leave 160 mm of type empty for lead in (20 empty pockets)
6. Leave 480 mm of type empty for trailer (60 empty pockets)
7. All dimensions must comply to EIA-481-D
8. Final tape and reel packaging must meet the requirements of JEDEC-STD-033, LEVEL 2A.

Packaging and Labeling

Packaged Reel

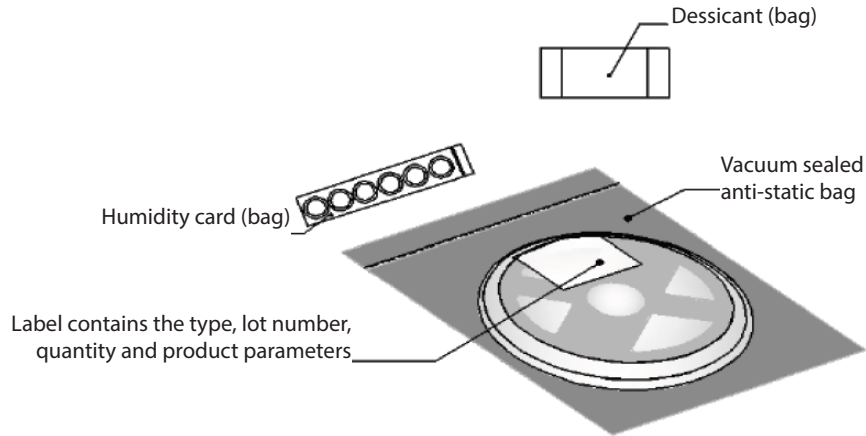

Label on Reel

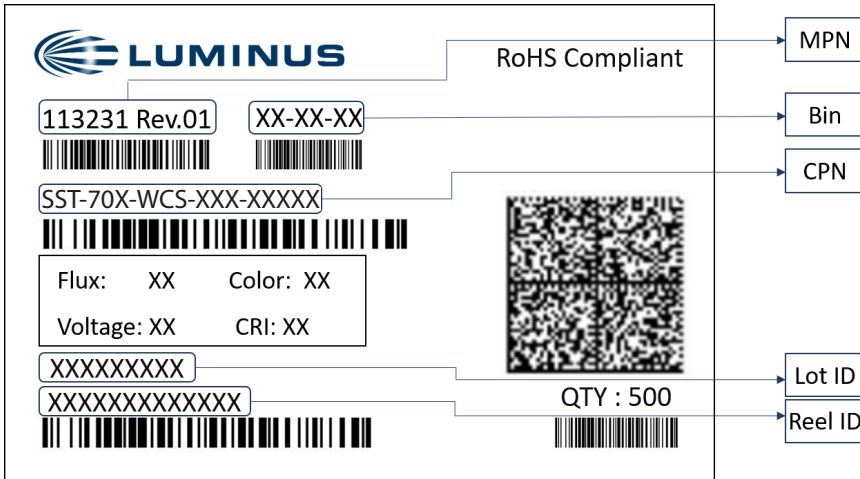

Label Information	
CPN	Luminus ordering part number
MPN	For Luminus internal use
QTY	Quantity of parts per reel
Flux	Single flux bin code (see <i>Luminous Flux Binning</i> table on page 3)
Voltage	V1
Color	Single chromaticity bin code (see <i>Chromaticity Bin Coordinates</i> table on page 4)
CRI	N/A
Lot ID & Reel ID	For Luminus internal use

Packaging Boxes

Box Size 1 - 5 reels per box
 Size: 22.5 x 24.5 x 6.5 cm

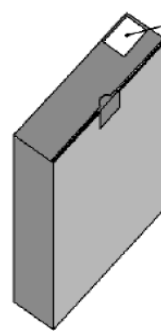
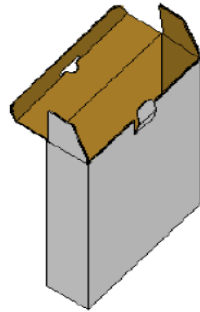

Label contains the type, lot number, quantity and product parameters

Box Size 2 - 10 reels per box
 Size: 22.5 x 24.5 x 13 cm

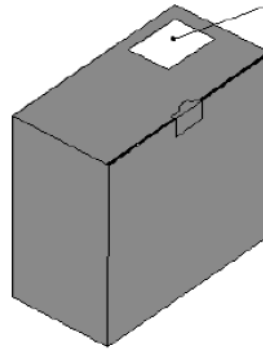
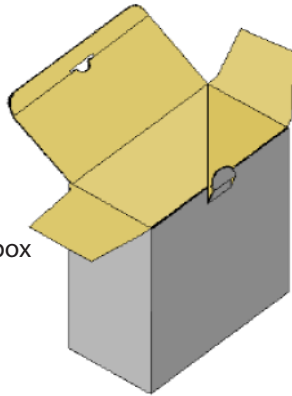

Label contains the type, lot number, quantity and product parameters

Shipping Label on Packaging Box

Multiple labels are attached to the box (one label per reel inside the box)

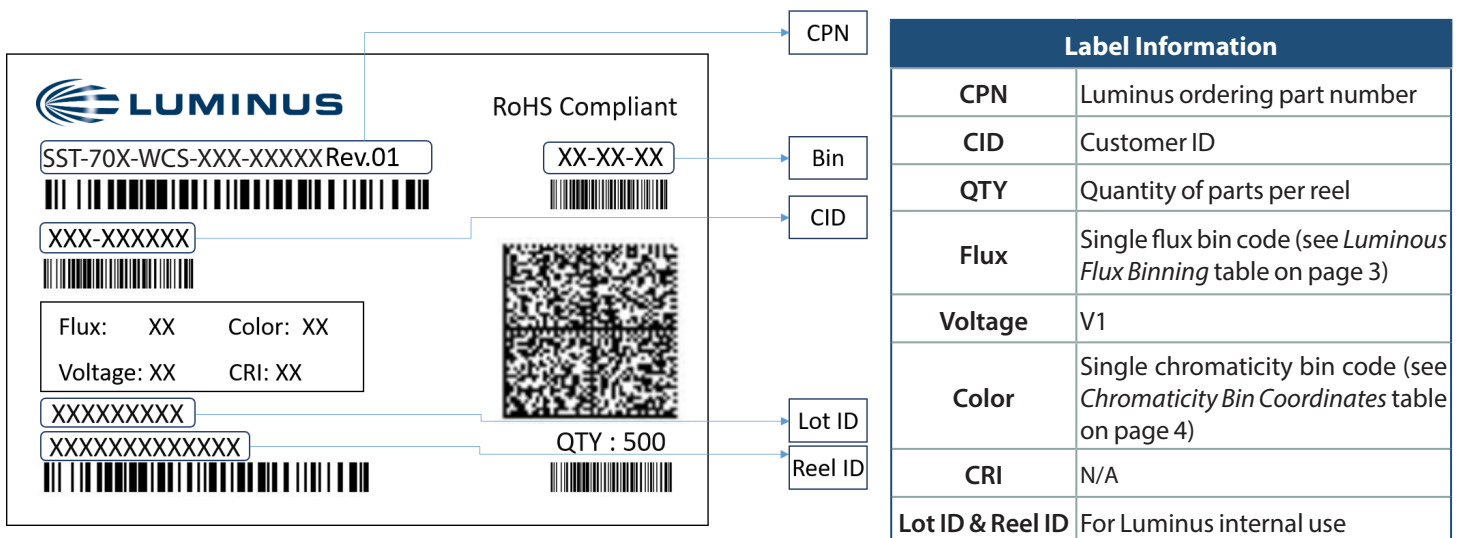

Label Information	
CPN	Luminus ordering part number
CID	Customer ID
QTY	Quantity of parts per reel
Flux	Single flux bin code (see <i>Luminus Flux Binning</i> table on page 3)
Voltage	V1
Color	Single chromaticity bin code (see <i>Chromaticity Bin Coordinates</i> table on page 4)
CRI	N/A
Lot ID & Reel ID	For Luminus internal use