

ALS31A223MF100

Aliases (A431PM223M100A)

ALS31, Aluminum Electrolytic, 22,000 uF, 20%, 100 VDC, -40/+85°C

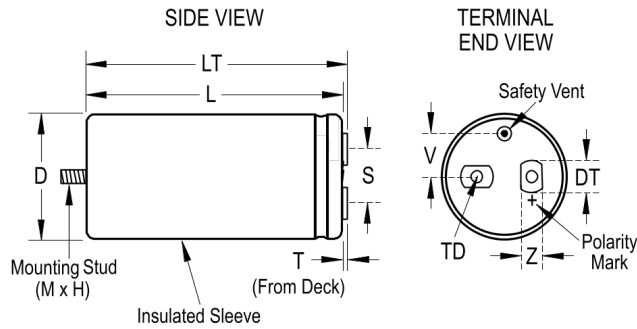

Click [here](#) for the 3D model.

Dimensions

D	66mm +/-1mm
L	105mm +/-2mm
T	5.5mm +/-0.5mm
S	28.5mm +/-0.5mm
DT	13mm +/-0.5mm
LT	110.5mm +/-1mm
TD	10mm MIN
V	15.8mm NOM
Z	10mm NOM

Packaging Specifications

Sleeving	Yes
Packaging	Bulk, Box

General Information

Series	ALS31
Dielectric	Aluminum Electrolytic
Description	Screw Terminal, Aluminum Electrolytic
RoHS	Yes
AEC-Q200	No
Component Weight	505 g
Notes	Dimensions D And L Include Sleeving. MS (MxH) = M12x16.
Shelf Life	156 Weeks

Specifications

Capacitance	22,000 uF
Capacitance Tolerance	20%
Voltage DC	100 VDC, 115 VDC (Surge)
Temperature Range	-40/+85°C
Rated Temperature	85°C
Life	19000 Hrs (Rated Voltage And Ripple Current At 85C), 38000 Hrs (Rated Voltage At 85C)
Resistance	13 mOhms (100Hz 20C), 12 mOhms (10kHz 20C)
Ripple Current	18.4 Amps (100Hz 85C), 19.1 Amps (10kHz 85C)
Leakage Current	6000 uA (5min 20°C)