



140×140×38 mm

San Ace 140 9GV type

General Specifications

- Material Frame: Aluminum, Impeller: Plastic (Flammability: UL 94V-1)
- Expected life See the table below. (L10 life: 90% survival rate for continuous operation in free air at 60°C, rated voltage)
- Motor protection function Locked rotor burnout protection, Reverse polarity protection
For details, please refer to p. 547.
- Dielectric strength 50/60 Hz, 500 VAC, for 1 minute (between lead wire conductors and frame)
- Insulation resistance 10 MΩ or more with a 500 VDC megger (between lead wire conductors and frame)
- Sound pressure level (SPL) At 1 m away from the air inlet
- Storage temperature -30 to +70°C (Non-condensing)
- Lead wire ⊕Red ⊖Black (Sensor) Yellow (Control) Brown
- Mass 630 g

Specifications

The models listed below **have pulse sensors with PWM control function.**

Model no.	Rated voltage [V]	Operating voltage range [V]	PWM duty cycle* [%]	Rated current [A]	Rated input [W]	Rated speed [min ⁻¹]	Max. airflow [m ³ /min] [CFM]	Max. static pressure [Pa] [inchH ₂ O]	SPL [dB (A)]	Operating temperature [°C]	Expected life [h]
9GV1412P1G001	12	10.8 to 13.2	100	4.6	55.2	7600	8.8 310	640 2.57	70	-20 to +70	40000/60°C
			20	0.26	3.12	2300	2.66 93	80 0.32	39		
9GV1412P1S001			100	3.1	37.2	6650	7.7 272	480 1.93	67		
			20	0.26	3.12	2300	2.66 93	80 0.32	39		
9GV1412P1H001			100	1.7	20.4	5200	6.0 212	300 1.2	62		
			20	0.26	3.12	2300	2.66 93	80 0.32	39		
9GV1424P1G001	24	21.6 to 26.4	100	2.3	55.2	7600	8.8 310	640 2.57	70		
			20	0.13	3.12	2300	2.66 93	80 0.32	39		
9GV1424P1S001			100	1.55	37.2	6650	7.7 272	480 1.93	67		
			20	0.13	3.12	2300	2.66 93	80 0.32	39		
9GV1424P1H001			100	0.85	20.4	5200	6.0 212	300 1.2	62		
			20	0.13	3.12	2300	2.66 93	80 0.32	39		
9GV1448P1G001	48	36 to 60	100	1.15	55.2	7600	8.8 310	640 2.57	70		
			20	0.11	5.28	2300	2.66 93	80 0.32	39		
9GV1448P1S001			100	0.78	37.44	6650	7.7 272	480 1.93	67		
			20	0.11	5.28	2300	2.66 93	80 0.32	39		
9GV1448P1H001			100	0.42	20.16	5200	6.0 212	300 1.2	62		
			20	0.11	5.28	2300	2.66 93	80 0.32	39		

* PWM frequency: 25 kHz. Fan does not rotate when PWM duty cycle is 0%.

Airflow - Static Pressure Characteristics / PWM Duty - Speed Characteristics Example

9GV1412P1G001 With pulse sensor with PWM control function

PWM duty cycle

Operating voltage range

PWM duty - Speed characteristics example

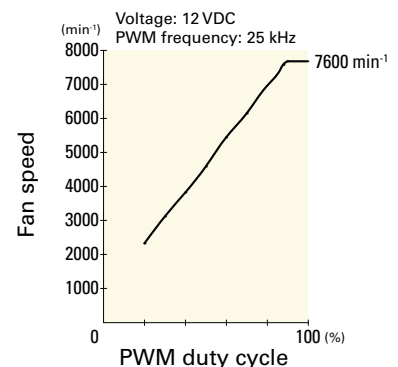
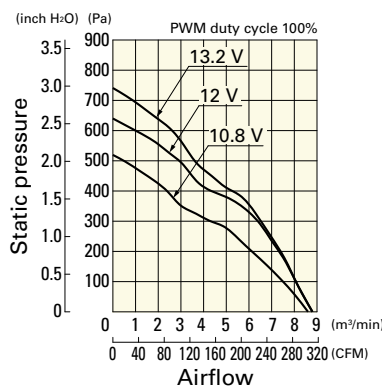
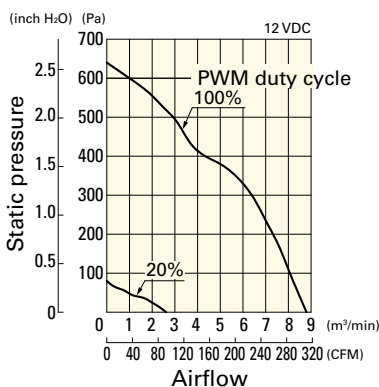

Airflow - Static Pressure Characteristics / PWM Duty - Speed Characteristics Example

9GV1412P1S001 With pulse sensor with PWM control function

PWM duty cycle

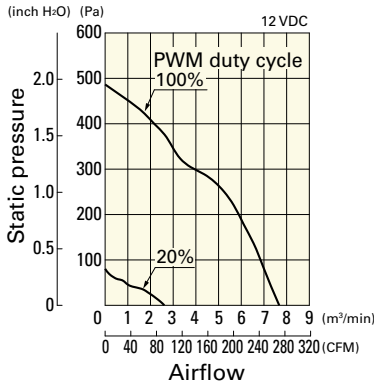

Operating voltage range

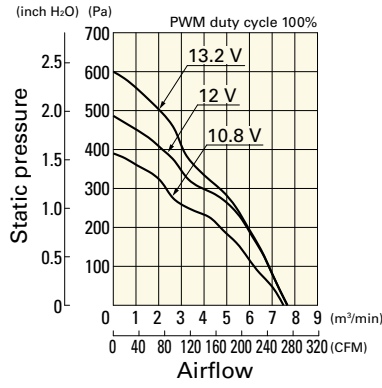

PWM duty - Speed characteristics example

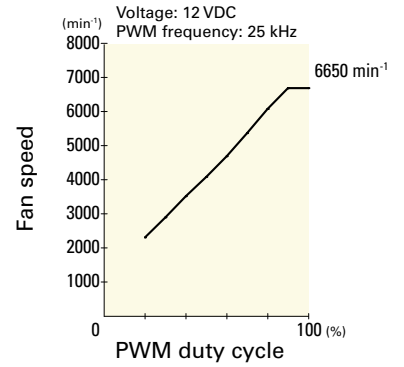

9GV1412P1H001 With pulse sensor with PWM control function

PWM duty cycle

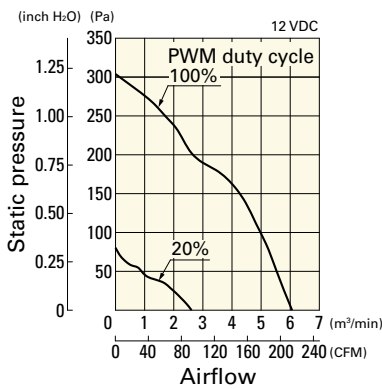

Operating voltage range

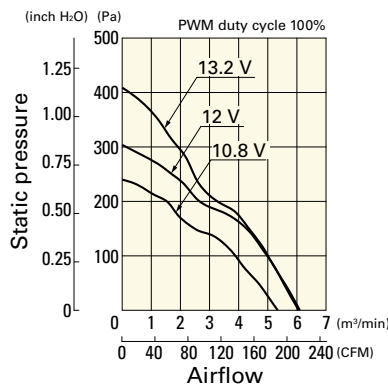

PWM duty - Speed characteristics example

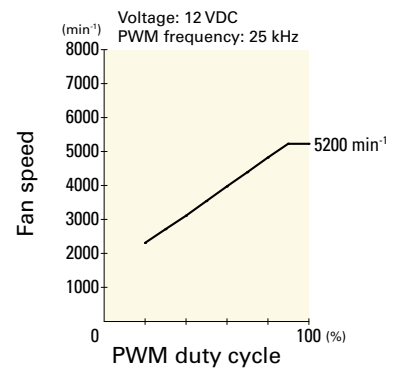

9GV1424P1G001 With pulse sensor with PWM control function

PWM duty cycle

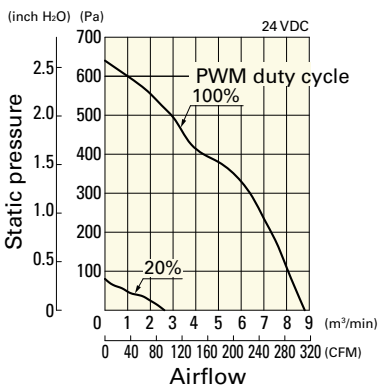

Operating voltage range

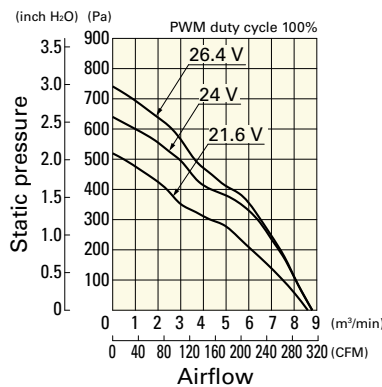

PWM duty - Speed characteristics example

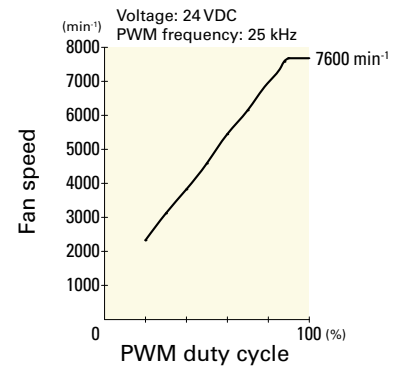

9GV1424P1S001 With pulse sensor with PWM control function

PWM duty cycle

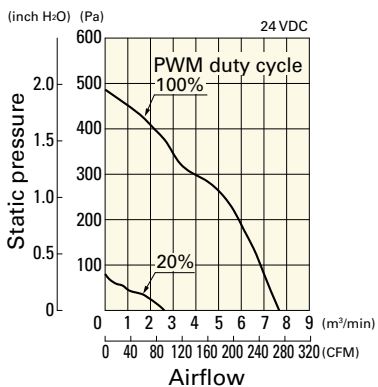

Operating voltage range

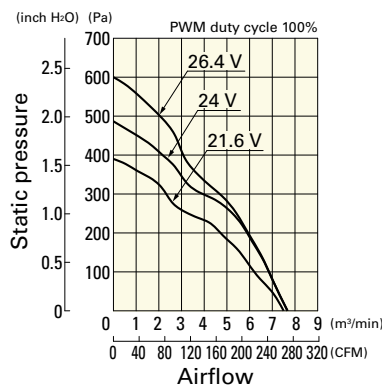

PWM duty - Speed characteristics example

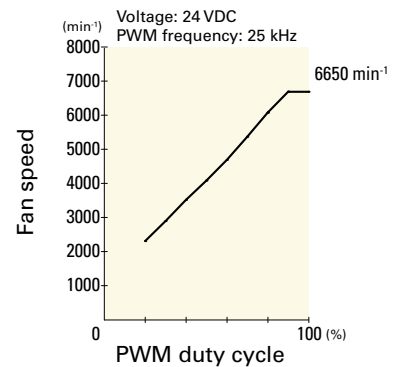

Airflow - Static Pressure Characteristics / PWM Duty - Speed Characteristics Example

9GV1424P1H001 With pulse sensor with PWM control function

PWM duty cycle

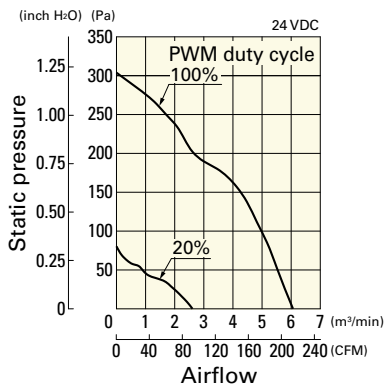

Operating voltage range

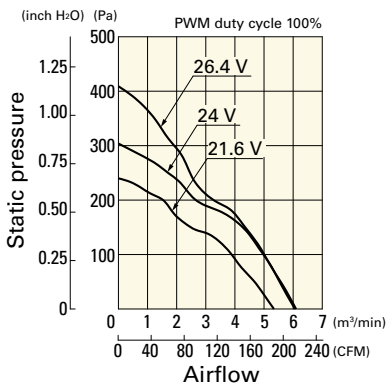

PWM duty - Speed characteristics example

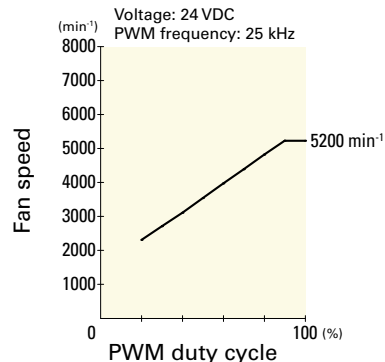

9GV1448P1G001 With pulse sensor with PWM control function

PWM duty cycle

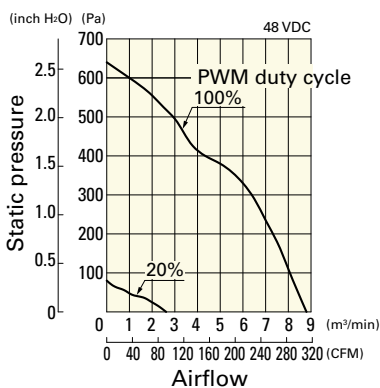

Operating voltage range

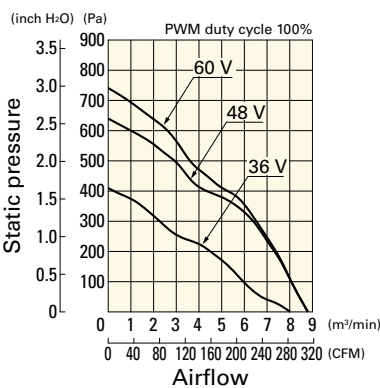

PWM duty - Speed characteristics example

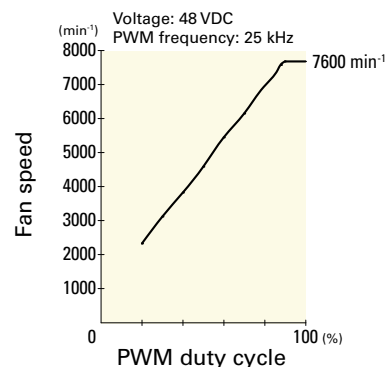

9GV1448P1S001 With pulse sensor with PWM control function

PWM duty cycle

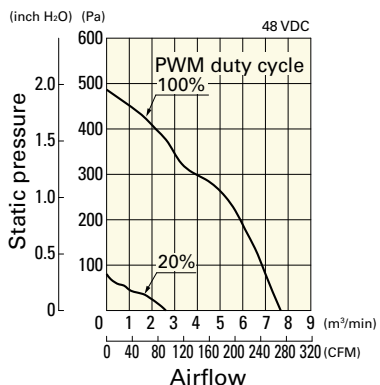

Operating voltage range

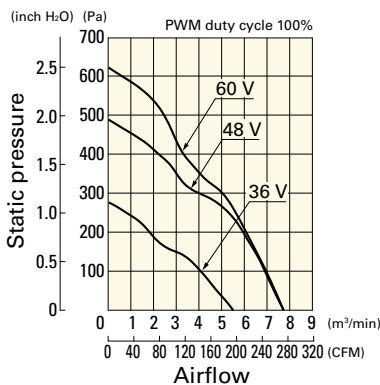

PWM duty - Speed characteristics example

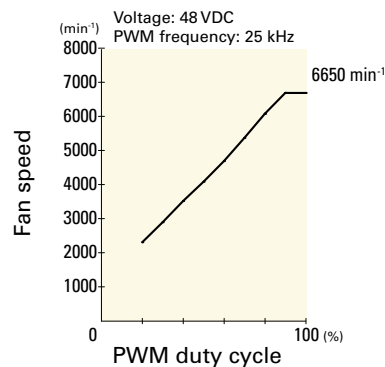

9GV1448P1H001 With pulse sensor with PWM control function

PWM duty cycle

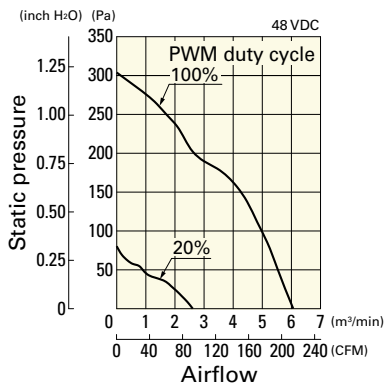

Operating voltage range

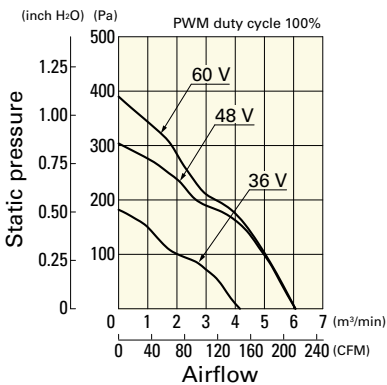

PWM duty - Speed characteristics example

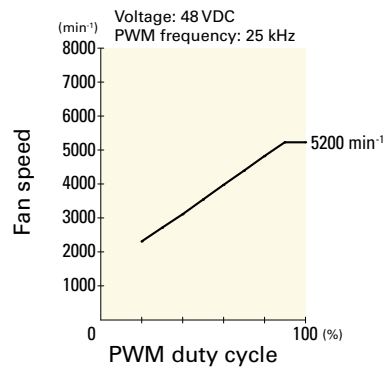

Dimensions (unit: mm)

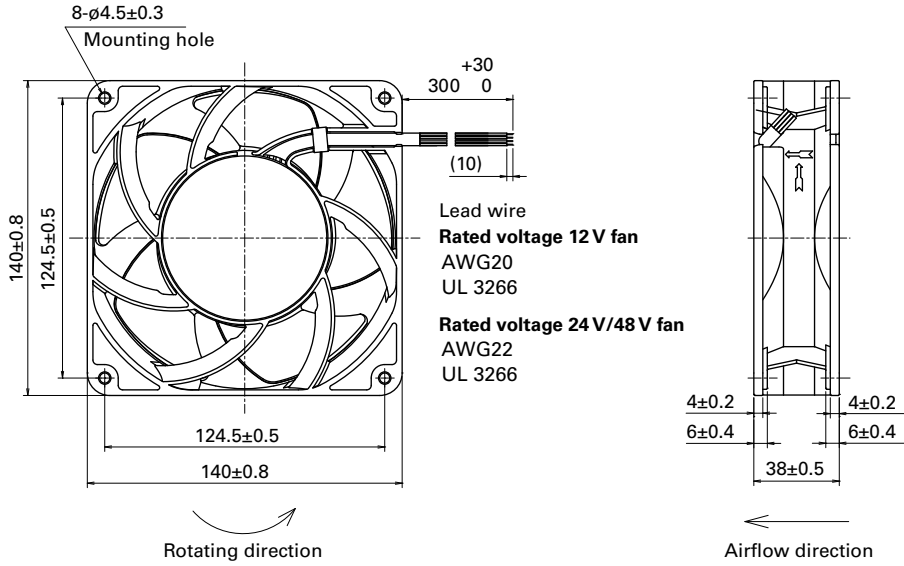

Reference Dimensions of Mounting Holes and Vent Opening (unit: mm)

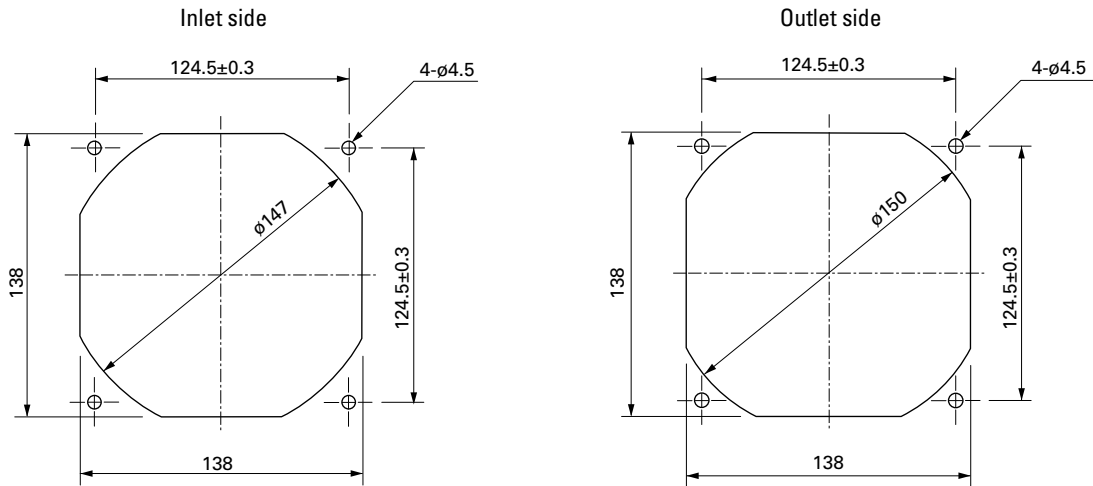

Options

Finger guards

page: p. 533

Model no.: 109-719, 109-719H