

# 74LVC2G32

Dual 2-input OR gate

Rev. 13 — 3 July 2017

Product data sheet

## 1 General description

The 74LVC2G32 provides a 2-input OR gate function.

Inputs can be driven from either 3.3 V or 5 V devices. This feature allows the use of these devices as translators in a mixed 3.3 V and 5 V environment.

This device is fully specified for partial power-down applications using  $I_{OFF}$ . The  $I_{OFF}$  circuitry disables the output, preventing a damaging backflow current through the device when it is powered down.

## 2 Features and benefits

- Wide supply voltage range from 1.65 V to 5.5 V
- 5 V tolerant outputs in the Power-down mode
- High noise immunity
- $\pm 24$  mA output drive ( $V_{CC} = 3.0$  V)
- CMOS low power consumption
- Complies with JEDEC standard:
  - JESD8-7 (1.65 V to 1.95 V)
  - JESD8-5 (2.3 V to 2.7 V)
  - JESD8-B/JESD36 (2.7 V to 3.6 V)
- Latch-up performance exceeds 250 mA
- Direct interface with TTL levels
- Inputs accept voltages up to 5 V
- ESD protection:
  - HBM JESD22-A114F exceeds 2000 V
  - MM JESD22-A115-A exceeds 200 V
- Multiple package options
- Specified from  $-40$  °C to  $+85$  °C and  $-40$  °C to  $+125$  °C

## 3 Ordering information

Table 1. Ordering information

Type number	Package			
	Temperature range	Name	Description	Version
74LVC2G32DP	$-40$ °C to $+125$ °C	TSSOP8	plastic thin shrink small outline package; 8 leads; body width 3 mm; lead length 0.5 mm	SOT505-2
74LVC2G32DC	$-40$ °C to $+125$ °C	VSSOP8	plastic very thin shrink small outline package; 8 leads; body width 2.3 mm	SOT765-1

Type number	Package			
	Temperature range	Name	Description	Version
74LVC2G32GT	-40 °C to +125 °C	XSON8	plastic extremely thin small outline package; no leads; 8 terminals; body 1 x 1.95 x 0.5 mm	SOT833-1
74LVC2G32GF	-40 °C to +125 °C	XSON8	extremely thin small outline package; no leads; 8 terminals; body 1.35 x 1 x 0.5 mm	SOT1089
74LVC2G32GM	-40 °C to +125 °C	XQFN8	plastic, extremely thin quad flat package; no leads; 8 terminals; body 1.6 x 1.6 x 0.5 mm	SOT902-2
74LVC2G32GN	-40 °C to +125 °C	XSON8	extremely thin small outline package; no leads; 8 terminals; body 1.2 x 1.0 x 0.35 mm	SOT1116
74LVC2G32GS	-40 °C to +125 °C	XSON8	extremely thin small outline package; no leads; 8 terminals; body 1.35 x 1.0 x 0.35 mm	SOT1203
74LVC2G32GX	-40 °C to +125 °C	X2SON8	plastic thermal enhanced extremely thin small outline package; no leads; 8 terminals; body 1.35 x 0.8 x 0.35 mm	SOT1233

## 4 Marking

Table 2. Marking codes

Type number	Marking code <sup>[1]</sup>
74LVC2G32DP	V32
74LVC2G32DC	V32
74LVC2G32GT	V32
74LVC2G32GF	VG
74LVC2G32GM	V32
74LVC2G32GN	VG
74LVC2G32GS	VG
74LVC2G32GX	VG

[1] The pin 1 indicator is located on the lower left corner of the device, below the marking code.

## 5 Functional diagram

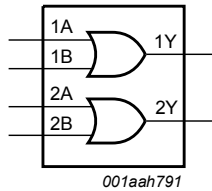

Figure 1. Logic symbol

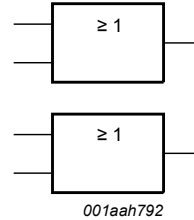

Figure 2. IEC logic symbol

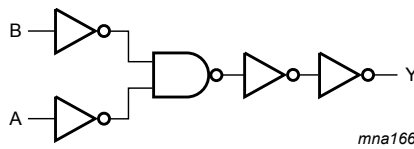

Figure 3. Logic diagram (one gate)

## 6 Pinning information

### 6.1 Pinning

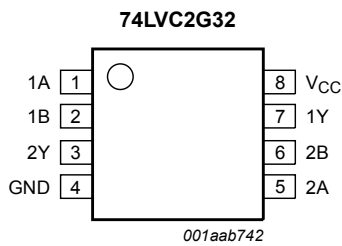

Figure 4. Pin configuration SOT505-2 and SOT765-1

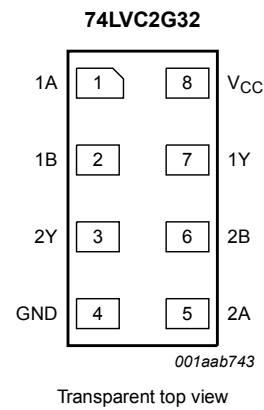

Figure 5. Pin configuration SOT833-1, SOT1089, SOT1116 and SOT1203

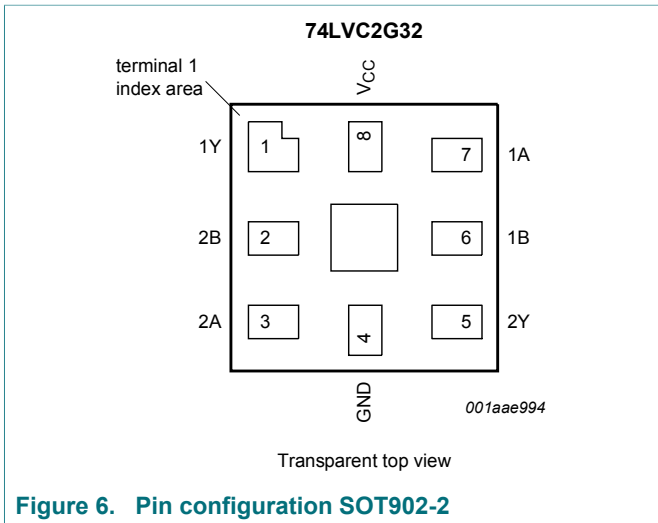

Figure 6. Pin configuration SOT902-2

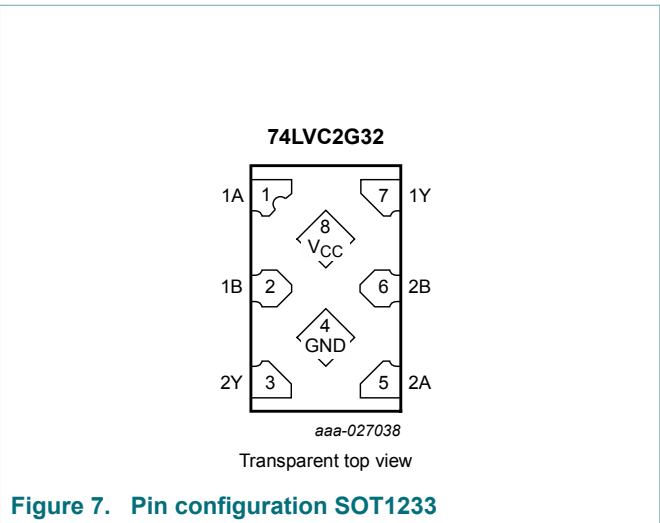

Figure 7. Pin configuration SOT1233

## 6.2 Pin description

Table 3. Pin description

Symbol	Pin		Description
	SOT505-2, SOT765-1, SOT833-1, SOT1089, SOT1116, SOT1203 and SOT1233	SOT902-2	
1A, 2A	1, 5	7, 3	data input
1B, 2B	2, 6	6, 2	data input
GND	4	4	ground (0 V)
1Y, 2Y	7, 3	1, 5	data output
V <sub>CC</sub>	8	8	supply voltage

## 7 Functional description

Table 4. Function table

H = HIGH voltage level; L = LOW voltage level.

Input		Output
nA	nB	nY
L	L	L
L	H	H
H	L	H
H	H	H

## 8 Limiting values

**Table 5. Limiting values**

In accordance with the Absolute Maximum Rating System (IEC 60134). Voltages are referenced to GND (ground = 0 V).

Symbol	Parameter	Conditions	Min	Max	Unit
$V_{CC}$	supply voltage		-0.5	+6.5	V
$V_I$	input voltage	[1]	-0.5	+6.5	V
$V_O$	output voltage	Active mode [1]	-0.5	$V_{CC} + 0.5$	V
		Power-down mode [2]	-0.5	+6.5	V
$I_{IK}$	input clamping current	$V_I < 0$ V	-50	-	mA
$I_{OK}$	output clamping current	$V_O < 0$ V or $V_O > V_{CC}$	-	$\pm 50$	mA
$I_O$	output current	$V_O = 0$ V to $V_{CC}$	-	$\pm 50$	mA
$I_{CC}$	supply current		-	100	mA
$I_{GND}$	ground current		-100	-	mA
$T_{stg}$	storage temperature		-65	+150	°C
$P_{tot}$	total power dissipation	$T_{amb} = -40$ °C to +125 °C [3]	-	300	mW

[1] The input and output voltage ratings may be exceeded if the input and output current ratings are observed.

[2] When  $V_{CC} = 0$  V (Power-down mode), the output voltage can be 5.5 V in normal condition.

[3] For TSSOP8 package: above 55 °C the value of  $P_{tot}$  derates linearly with 2.5 mW/K.

For VSSOP8 package: above 110 °C the value of  $P_{tot}$  derates linearly with 8 mW/K.

For XSON8 and XQFN8 packages: above 118 °C the value of  $P_{tot}$  derates linearly with 7.8 mW/K.

For X2SON8 package: above 118 °C the value of  $P_{tot}$  derates linearly with 7.7 mW/K.

## 9 Recommended operating conditions

**Table 6. Operating conditions**

Symbol	Parameter	Conditions	Min	Max	Unit
$V_{CC}$	supply voltage		1.65	5.5	V
$V_I$	input voltage		0	5.5	V
$V_O$	output voltage	Active mode	0	$V_{CC}$	V
		Power-down mode	0	5.5	V
$T_{amb}$	ambient temperature		-40	+125	°C
$\Delta t/\Delta V$	input transition rise and fall rate	$V_{CC} = 1.65$ V to 2.7 V	-	20	ns/V
		$V_{CC} = 2.7$ V to 5.5 V	-	10	ns/V

## 10 Static characteristics

**Table 7. Static characteristics**

At recommended operating conditions; voltages are referenced to GND (ground = 0 V).

Symbol	Parameter	Conditions	Min	Typ <sup>[1]</sup>	Max	Unit
$T_{amb} = -40\text{ }^{\circ}\text{C to }+85\text{ }^{\circ}\text{C}$						
$V_{IH}$	HIGH-level input voltage	$V_{CC} = 1.65\text{ V to }1.95\text{ V}$	$0.65 \times V_{CC}$	-	-	V
		$V_{CC} = 2.3\text{ V to }2.7\text{ V}$	1.7	-	-	V
		$V_{CC} = 2.7\text{ V to }3.6\text{ V}$	2.0	-	-	V
		$V_{CC} = 4.5\text{ V to }5.5\text{ V}$	$0.7 \times V_{CC}$	-	-	V
$V_{IL}$	LOW-level input voltage	$V_{CC} = 1.65\text{ V to }1.95\text{ V}$	-	-	$0.35 \times V_{CC}$	V
		$V_{CC} = 2.3\text{ V to }2.7\text{ V}$	-	-	0.7	V
		$V_{CC} = 2.7\text{ V to }3.6\text{ V}$	-	-	0.8	V
		$V_{CC} = 4.5\text{ V to }5.5\text{ V}$	-	-	$0.3 \times V_{CC}$	V
$V_{OH}$	HIGH-level output voltage	$V_I = V_{IH}$ or $V_{IL}$				
		$I_O = -100\text{ }\mu\text{A}$ ; $V_{CC} = 1.65\text{ V to }5.5\text{ V}$	$V_{CC} - 0.1$	-	-	V
		$I_O = -4\text{ mA}$ ; $V_{CC} = 1.65\text{ V}$	1.2	1.53	-	V
		$I_O = -8\text{ mA}$ ; $V_{CC} = 2.3\text{ V}$	1.9	2.13	-	V
		$I_O = -12\text{ mA}$ ; $V_{CC} = 2.7\text{ V}$	2.2	2.50	-	V
		$I_O = -24\text{ mA}$ ; $V_{CC} = 3.0\text{ V}$	2.3	2.60	-	V
		$I_O = -32\text{ mA}$ ; $V_{CC} = 4.5\text{ V}$	3.8	4.10	-	V
$V_{OL}$	LOW-level output voltage	$V_I = V_{IH}$ or $V_{IL}$				
		$I_O = 100\text{ }\mu\text{A}$ ; $V_{CC} = 1.65\text{ V to }5.5\text{ V}$	-	-	0.1	V
		$I_O = 4\text{ mA}$ ; $V_{CC} = 1.65\text{ V}$	-	0.08	0.45	V
		$I_O = 8\text{ mA}$ ; $V_{CC} = 2.3\text{ V}$	-	0.14	0.3	V
		$I_O = 12\text{ mA}$ ; $V_{CC} = 2.7\text{ V}$	-	0.19	0.4	V
		$I_O = 24\text{ mA}$ ; $V_{CC} = 3.0\text{ V}$	-	0.37	0.55	V
		$I_O = 32\text{ mA}$ ; $V_{CC} = 4.5\text{ V}$	-	0.43	0.55	V
$I_I$	input leakage current	$V_I = 5.5\text{ V}$ or GND; $V_{CC} = 0\text{ V to }5.5\text{ V}$	-	$\pm 0.1$	$\pm 1$	$\mu\text{A}$
$I_{OFF}$	power-off leakage current	$V_I$ or $V_O = 5.5\text{ V}$ ; $V_{CC} = 0\text{ V}$	-	$\pm 0.1$	$\pm 2$	$\mu\text{A}$
$I_{CC}$	supply current	$V_I = 5.5\text{ V}$ or GND; $V_{CC} = 1.65\text{ V to }5.5\text{ V}$ ; $I_O = 0\text{ A}$	-	0.1	4	$\mu\text{A}$
$\Delta I_{CC}$	additional supply current	per pin; $V_I = V_{CC} - 0.6\text{ V}$ ; $V_{CC} = 2.3\text{ V to }5.5\text{ V}$ ; $I_O = 0\text{ A}$	-	5	500	$\mu\text{A}$
$C_i$	input capacitance		-	2.5	-	pF

Symbol	Parameter	Conditions	Min	Typ <sup>[1]</sup>	Max	Unit
$T_{amb} = -40\text{ °C to }+125\text{ °C}$						
$V_{IH}$	HIGH-level input voltage	$V_{CC} = 1.65\text{ V to }1.95\text{ V}$	$0.65 \times V_{CC}$	-	-	V
		$V_{CC} = 2.3\text{ V to }2.7\text{ V}$	1.7	-	-	V
		$V_{CC} = 2.7\text{ V to }3.6\text{ V}$	2.0	-	-	V
		$V_{CC} = 4.5\text{ V to }5.5\text{ V}$	$0.7 \times V_{CC}$	-	-	V
$V_{IL}$	LOW-level input voltage	$V_{CC} = 1.65\text{ V to }1.95\text{ V}$	-	-	$0.35 \times V_{CC}$	V
		$V_{CC} = 2.3\text{ V to }2.7\text{ V}$	-	-	0.7	V
		$V_{CC} = 2.7\text{ V to }3.6\text{ V}$	-	-	0.8	V
		$V_{CC} = 4.5\text{ V to }5.5\text{ V}$	-	-	$0.3 \times V_{CC}$	V
$V_{OH}$	HIGH-level output voltage	$V_I = V_{IH}\text{ or }V_{IL}$				
		$I_O = -100\text{ }\mu\text{A}; V_{CC} = 1.65\text{ V to }5.5\text{ V}$	$V_{CC} - 0.1$	-	-	V
		$I_O = -4\text{ mA}; V_{CC} = 1.65\text{ V}$	0.95	-	-	V
		$I_O = -8\text{ mA}; V_{CC} = 2.3\text{ V}$	1.7	-	-	V
		$I_O = -12\text{ mA}; V_{CC} = 2.7\text{ V}$	1.9	-	-	V
		$I_O = -24\text{ mA}; V_{CC} = 3.0\text{ V}$	2.0	-	-	V
		$I_O = -32\text{ mA}; V_{CC} = 4.5\text{ V}$	3.4	-	-	V
$V_{OL}$	LOW-level output voltage	$V_I = V_{IH}\text{ or }V_{IL}$				
		$I_O = 100\text{ }\mu\text{A}; V_{CC} = 1.65\text{ V to }5.5\text{ V}$	-	-	0.1	V
		$I_O = 4\text{ mA}; V_{CC} = 1.65\text{ V}$	-	-	0.70	V
		$I_O = 8\text{ mA}; V_{CC} = 2.3\text{ V}$	-	-	0.45	V
		$I_O = 12\text{ mA}; V_{CC} = 2.7\text{ V}$	-	-	0.60	V
		$I_O = 24\text{ mA}; V_{CC} = 3.0\text{ V}$	-	-	0.80	V
		$I_O = 32\text{ mA}; V_{CC} = 4.5\text{ V}$	-	-	0.80	V
$I_I$	input leakage current	$V_I = 5.5\text{ V or GND}; V_{CC} = 0\text{ V to }5.5\text{ V}$	-	-	$\pm 1$	$\mu\text{A}$
$I_{OFF}$	power-off leakage current	$V_I\text{ or }V_O = 5.5\text{ V}; V_{CC} = 0\text{ V}$	-	-	$\pm 2$	$\mu\text{A}$
$I_{CC}$	supply current	$V_I = 5.5\text{ V or GND};$ $V_{CC} = 1.65\text{ V to }5.5\text{ V}; I_O = 0\text{ A}$	-	-	4	$\mu\text{A}$
$\Delta I_{CC}$	additional supply current	per pin; $V_I = V_{CC} - 0.6\text{ V};$ $V_{CC} = 2.3\text{ V to }5.5\text{ V}; I_O = 0\text{ A}$	-	-	500	$\mu\text{A}$

[1] All typical values are measured at  $T_{amb} = 25\text{ °C}$ .

## 11 Dynamic characteristics

**Table 8. Dynamic characteristics**

Voltages are referenced to GND (ground 0 V); for test circuit see [Figure 9](#).

Symbol	Parameter	Conditions	-40 °C to +85 °C			-40 °C to +125 °C		Unit
			Min	Typ <sup>[1]</sup>	Max	Min	Max	
$t_{pd}$	propagation delay	nA, nB to nY; see <a href="#">Figure 8</a> <sup>[2]</sup>						
		$V_{CC} = 1.65 \text{ V to } 1.95 \text{ V}$	1.3	3.9	8.8	1.3	11	ns
		$V_{CC} = 2.3 \text{ V to } 2.7 \text{ V}$	0.8	2.4	4.7	0.8	5.9	ns
		$V_{CC} = 2.7 \text{ V}$	0.8	2.7	4.8	0.8	6.0	ns
		$V_{CC} = 3.0 \text{ V to } 3.6 \text{ V}$	0.9	2.2	4.2	0.9	5.3	ns
		$V_{CC} = 4.5 \text{ V to } 5.5 \text{ V}$	0.7	1.7	3.2	0.7	4.0	ns
$C_{PD}$	power dissipation capacitance	per gate; $V_I = \text{GND to } V_{CC}$ <sup>[3]</sup>	-	14	-	-	-	pF

[1] Typical values are measured at nominal  $V_{CC}$  and at  $T_{amb} = 25 \text{ °C}$ .

[2]  $t_{pd}$  is the same as  $t_{PLH}$  and  $t_{PHL}$ .

[3]  $C_{PD}$  is used to determine the dynamic power dissipation ( $P_D$  in  $\mu\text{W}$ ).

$$P_D = C_{PD} \times V_{CC}^2 \times f_i \times N + \sum(C_L \times V_{CC}^2 \times f_o) \text{ where:}$$

$f_i$  = input frequency in MHz;

$f_o$  = output frequency in MHz;

$C_L$  = output load capacitance in pF;

$V_{CC}$  = supply voltage in V;

$N$  = number of inputs switching;

$\sum(C_L \times V_{CC}^2 \times f_o)$  = sum of outputs.

### 11.1 Waveforms and test circuit

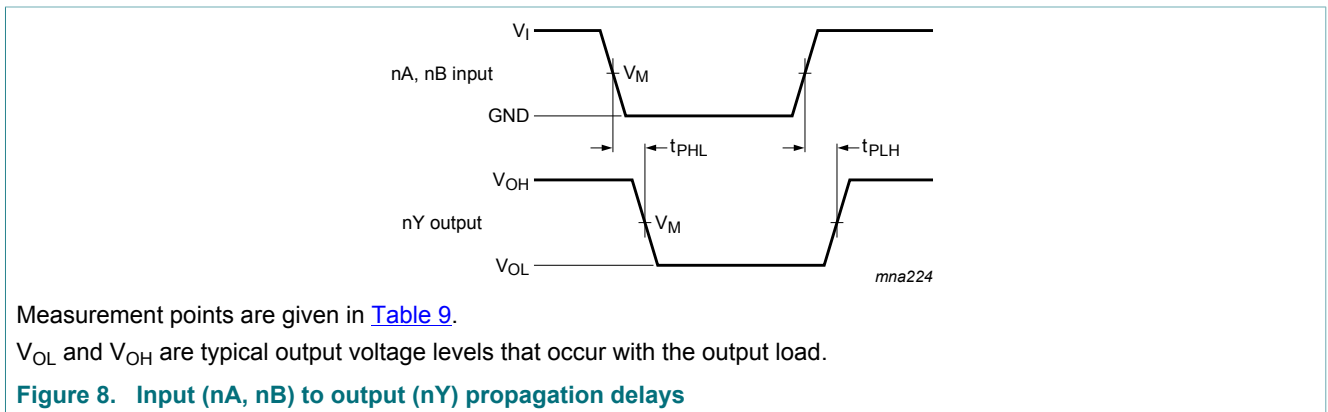
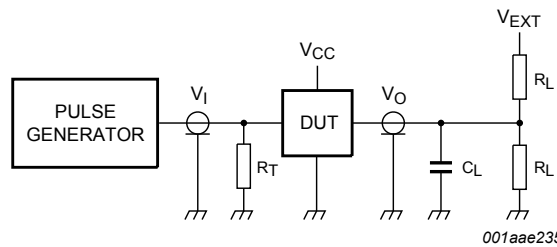
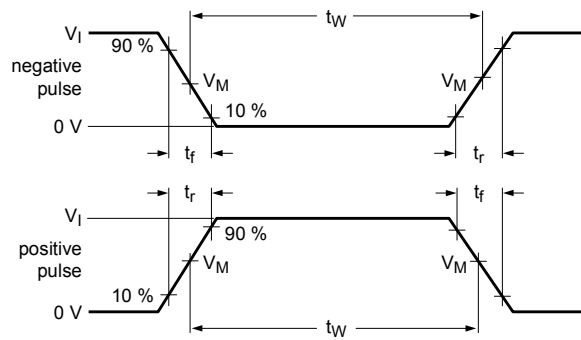



Table 9. Measurement points

Supply voltage	Input	Output
$V_{CC}$	$V_M$	$V_M$
1.65 V to 1.95 V	$0.5V_{CC}$	$0.5V_{CC}$
2.3 V to 2.7 V	$0.5V_{CC}$	$0.5V_{CC}$
2.7 V	1.5 V	1.5 V
3.0 V to 3.6 V	1.5 V	1.5 V
4.5 V to 5.5 V	$0.5V_{CC}$	$0.5V_{CC}$



Test data is given in [Table 10](#).

Definitions for test circuit:

$R_L$  = Load resistance

$C_L$  = Load capacitance including jig and probe capacitance

$R_T$  = Termination resistance should be equal to output impedance  $Z_o$  of the pulse generator

$V_{EXT}$  = Test voltage for switching times

Figure 9. Test circuit for measuring switching times

Table 10. Test data

Supply voltage	Input	Load	$V_{EXT}$		
$V_{CC}$	$V_I$	$C_L$	$t_{PLH}, t_{PHL}$		
1.65 V to 1.95 V	$V_{CC}$	$\leq 2.0$ ns	30 pF	1 k $\Omega$	open
2.3 V to 2.7 V	$V_{CC}$	$\leq 2.0$ ns	30 pF	500 $\Omega$	open
2.7 V	2.7 V	$\leq 2.5$ ns	50 pF	500 $\Omega$	open
3.0 V to 3.6 V	2.7 V	$\leq 2.5$ ns	50 pF	500 $\Omega$	open
4.5 V to 5.5 V	$V_{CC}$	$\leq 2.5$ ns	50 pF	500 $\Omega$	open

12 Package outline

TSSOP8: plastic thin shrink small outline package; 8 leads; body width 3 mm; lead length 0.5 mm SOT505-2



DIMENSIONS (mm are the original dimensions)

UNIT	A max.	A <sub>1</sub>	A <sub>2</sub>	A <sub>3</sub>	b <sub>p</sub>	c	D <sup>(1)</sup>	E <sup>(1)</sup>	e	H <sub>E</sub>	L	L <sub>p</sub>	v	w	y	Z <sup>(1)</sup>	θ
mm	1.1	0.15 0.00	0.95 0.75	0.25	0.38 0.22	0.18 0.08	3.1 2.9	3.1 2.9	0.65	4.1 3.9	0.5	0.47 0.33	0.2	0.13	0.1	0.70 0.35	8° 0°

Note

1. Plastic or metal protrusions of 0.15 mm maximum per side are not included.

OUTLINE VERSION	REFERENCES			EUROPEAN PROJECTION	ISSUE DATE
	IEC	JEDEC	JEITA		
SOT505-2		---			02-01-16

Figure 10. Package outline SOT505-2 (TSSOP8)

VSSOP8: plastic very thin shrink small outline package; 8 leads; body width 2.3 mm

SOT765-1



Dimensions (mm are the original dimensions)

Unit	A	A <sub>1</sub>	A <sub>2</sub>	A <sub>3</sub>	b <sub>p</sub>	c	D <sup>(1)</sup>	E <sup>(2)</sup>	e	H <sub>E</sub>	L	L <sub>p</sub>	Q	v	w	y	Z <sup>(1)</sup>	θ
	max.																	
mm	max	0.15	0.85		0.27	0.23	2.1	2.4		3.2		0.40	0.21					8°
	nom	1		0.12					0.5		0.4			0.2	0.08	0.1		
	min		0.00	0.60		0.17	0.08	1.9	2.2	3.0		0.15	0.19				0.1	0°

Note

1. Plastic or metal protrusions of 0.15 mm maximum per side are not included.
2. Plastic or metal protrusions of 0.25 mm maximum per side are not included.

sot765-1\_po

Outline version	References				European projection	Issue date
	IEC	JEDEC	JEITA			
SOT765-1		MO-187				07-06-02 16-05-31

Figure 11. Package outline SOT765-1 (VSSOP8)

XSON8: plastic extremely thin small outline package; no leads; 8 terminals; body 1 x 1.95 x 0.5 mm

SOT833-1

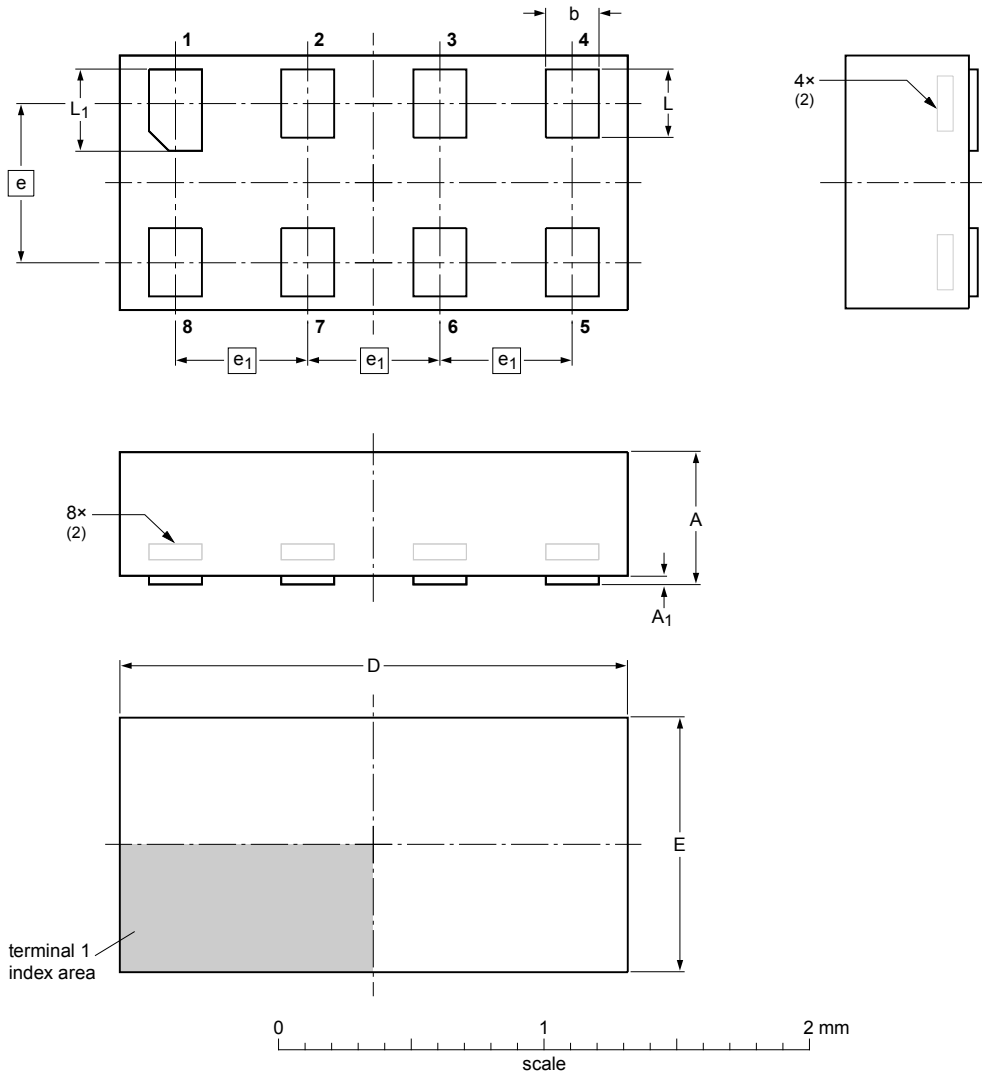

**DIMENSIONS** (mm are the original dimensions)

UNIT	A <sup>(1)</sup> max	A <sub>1</sub> max	b	D	E	e	e <sub>1</sub>	L	L <sub>1</sub>
mm	0.5	0.04	0.25 0.17	2.0 1.9	1.05 0.95	0.6	0.5	0.35 0.27	0.40 0.32

**Notes**

- Including plating thickness.
- Can be visible in some manufacturing processes.

OUTLINE VERSION	REFERENCES			EUROPEAN PROJECTION	ISSUE DATE
	IEC	JEDEC	JEITA		
SOT833-1	---	MO-252	---		07-11-14 07-12-07

Figure 12. Package outline SOT833-1 (XSON8)

XSON8: extremely thin small outline package; no leads;  
8 terminals; body 1.35 x 1 x 0.5 mm

SOT1089

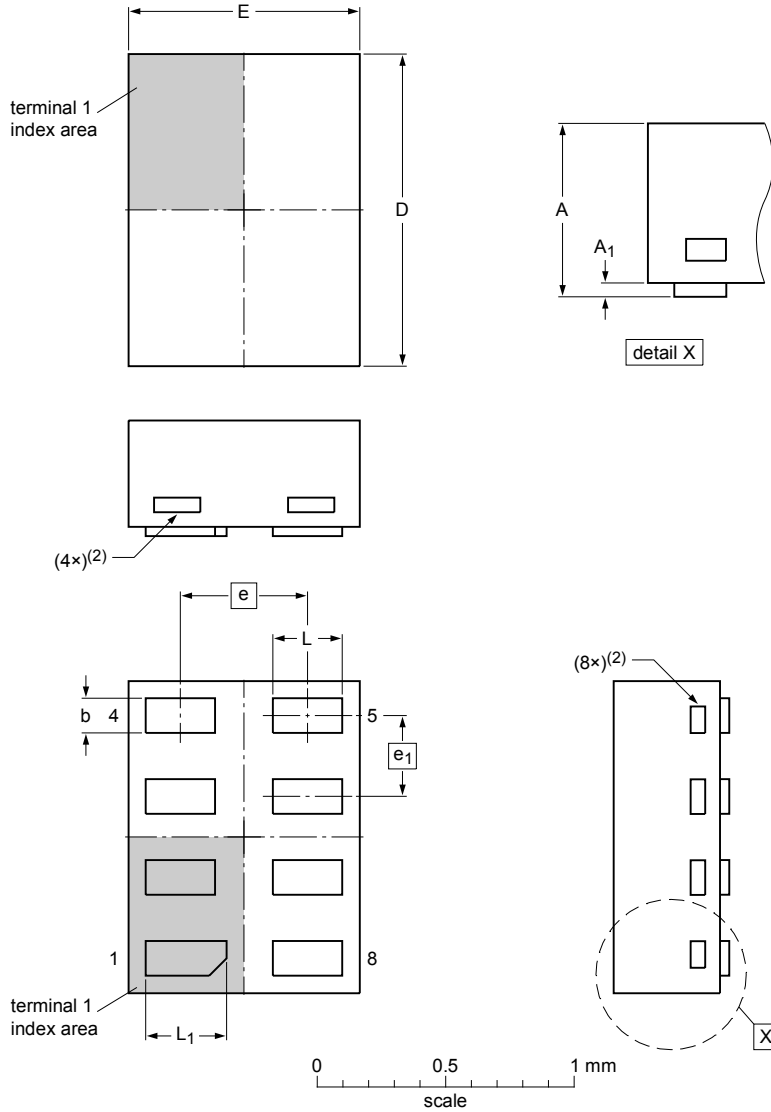

Dimensions

Unit	A <sup>(1)</sup>	A <sub>1</sub>	b	D	E	e	e <sub>1</sub>	L	L <sub>1</sub>
max	0.5	0.04	0.20	1.40	1.05			0.35	0.40
nom			0.15	1.35	1.00	0.55	0.35	0.30	0.35
min			0.12	1.30	0.95			0.27	0.32

Note

- Including plating thickness.
- Visible depending upon used manufacturing technology.

sot1089\_po

Outline version	References				European projection	Issue date
	IEC	JEDEC	JEITA			
SOT1089		MO-252				10-04-09 10-04-12

Figure 13. Package outline SOT1089 (XSON8)

**XQFN8: plastic, extremely thin quad flat package; no leads;  
8 terminals; body 1.6 x 1.6 x 0.5 mm**

**SOT902-2**

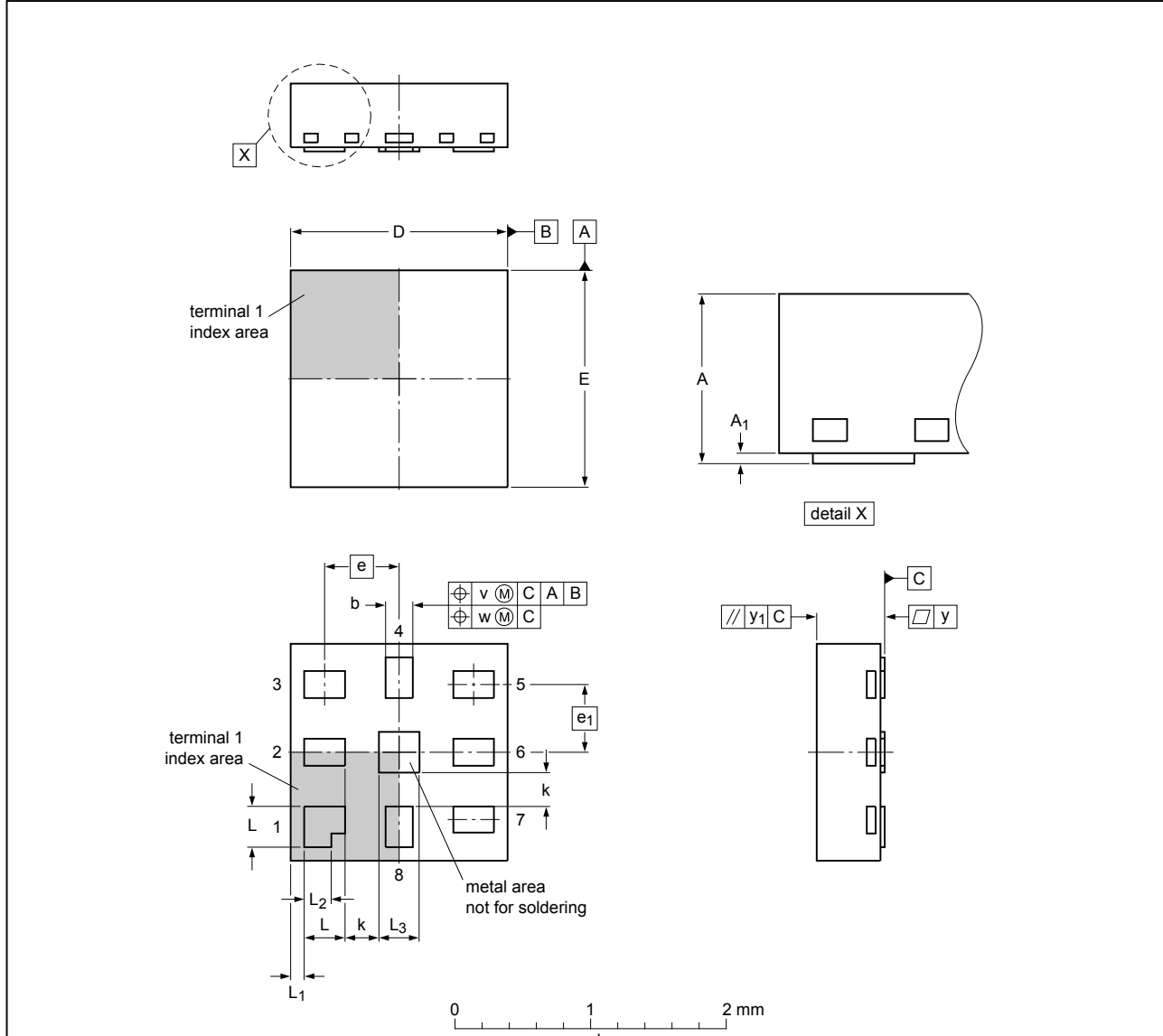

**Dimensions**

Unit <sup>(1)</sup>	A	A <sub>1</sub>	b	D	E	e	e <sub>1</sub>	k	L	L <sub>1</sub>	L <sub>2</sub>	L <sub>3</sub>	v	w	y	y <sub>1</sub>
max	0.5	0.05	0.25	1.65	1.65				0.35	0.15	0.25	0.35				
mm	nom		0.20	1.60	1.60	0.55	0.5		0.30	0.10	0.20	0.30	0.1	0.05	0.05	0.05
	min	0.00	0.15	1.55	1.55			0.2	0.25	0.05	0.15	0.25				

**Note**

1. Plastic or metal protrusions of 0.075 mm maximum per side are not included.

sot902-2\_po

Outline version	References				European projection	Issue date
	IEC	JEDEC	JEITA			
SOT902-2	---	MO-255	---			16-07-14 16-11-08

**Figure 14. Package outline SOT902-2 (XQFN8)**

XSON8: extremely thin small outline package; no leads;  
8 terminals; body 1.2 x 1.0 x 0.35 mm

SOT1116

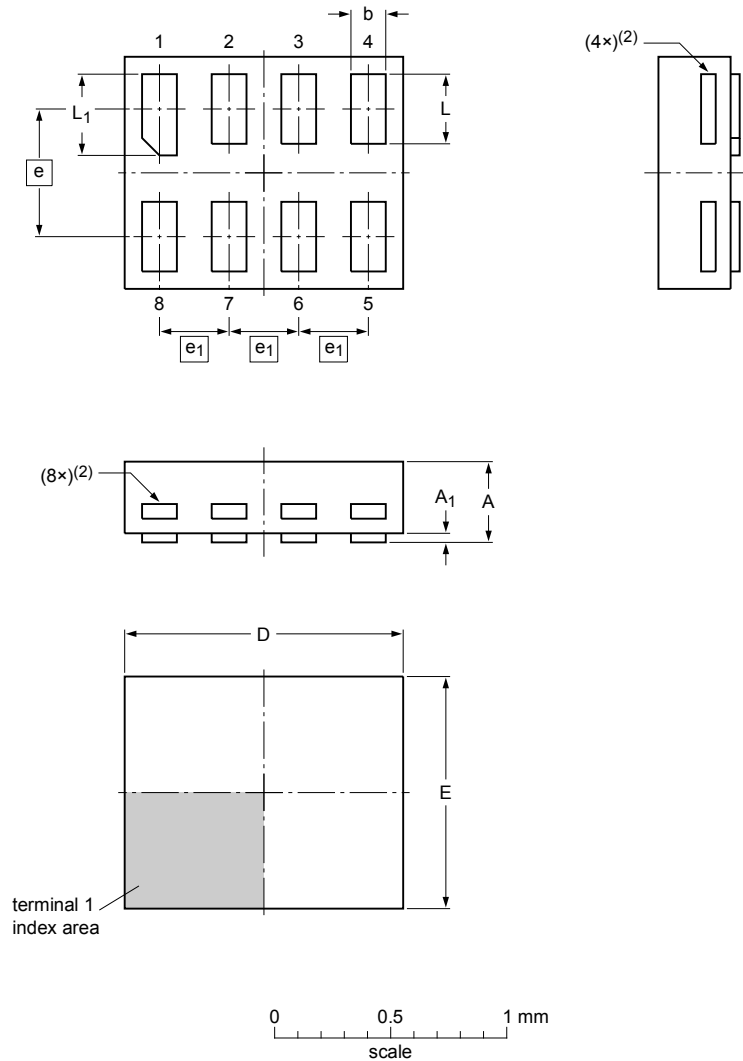

Dimensions

Unit	A <sup>(1)</sup>	A <sub>1</sub>	b	D	E	e	e <sub>1</sub>	L	L <sub>1</sub>
max	0.35	0.04	0.20	1.25	1.05			0.35	0.40
nom			0.15	1.20	1.00	0.55	0.3	0.30	0.35
min			0.12	1.15	0.95			0.27	0.32

Note

- Including plating thickness.
- Visible depending upon used manufacturing technology.

sot1116\_po

Outline version	References				European projection	Issue date
	IEC	JEDEC	JEITA			
SOT1116						-10-04-02- 10-04-07

Figure 15. Package outline SOT1116 (XSON8)

XSON8: extremely thin small outline package; no leads;  
8 terminals; body 1.35 x 1.0 x 0.35 mm

SOT1203

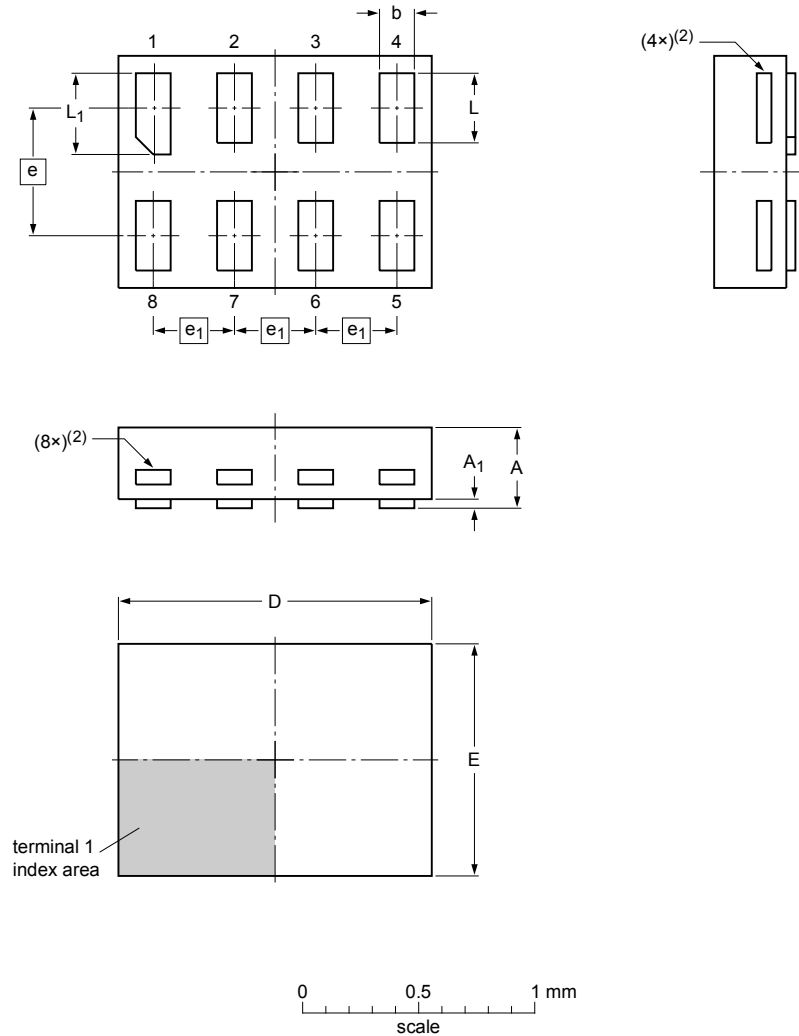

Dimensions

Unit	A <sup>(1)</sup>	A <sub>1</sub>	b	D	E	e	e <sub>1</sub>	L	L <sub>1</sub>
mm	max 0.35	0.04	0.20	1.40	1.05			0.35	0.40
	nom 0.15	1.35	1.00	0.55	0.35	0.30	0.35		
	min 0.12	1.30	0.95			0.27	0.32		

Note

- Including plating thickness.
- Visible depending upon used manufacturing technology.

sot1203\_po

Outline version	References				European projection	Issue date
	IEC	JEDEC	JEITA			
SOT1203						-10-04-02- 10-04-06

Figure 16. Package outline SOT1203 (XSON8)



X2SON8: plastic thermal enhanced extremely thin small outline package; no leads;  
8 terminals; body 1.35 x 0.8 x 0.35 mm

SOT1233

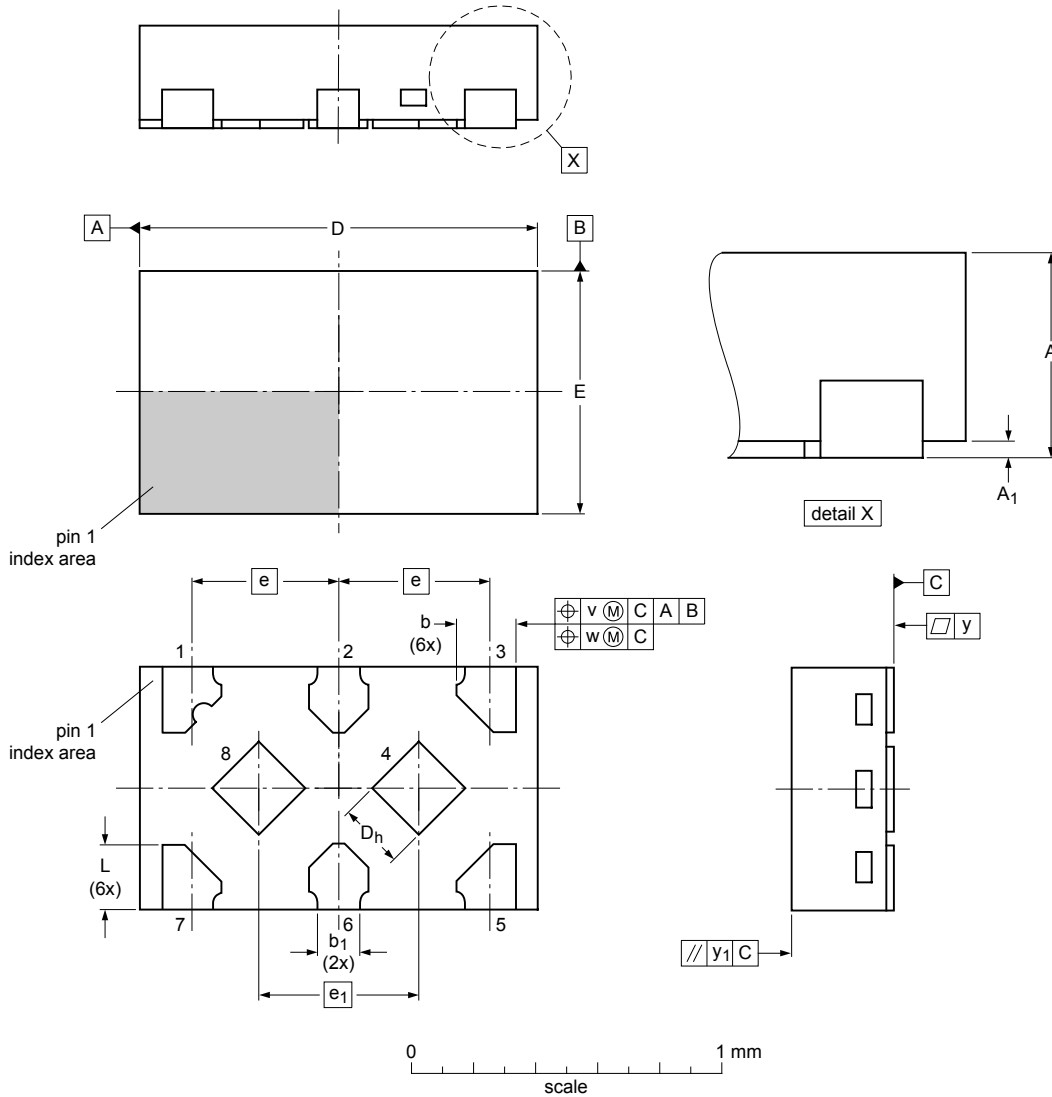

Dimensions (mm are the original dimensions)

Unit	A	A <sub>1</sub>	b	b <sub>1</sub>	D	D <sub>h</sub>	E	e	e <sub>1</sub>	L	v	w	y	y <sub>1</sub>
max	0.35	0.04	0.25		1.40	0.27	0.85			0.27				
nom	0.32		0.20	0.15	1.35	0.22	0.80	0.5	0.54	0.22	0.1	0.05	0.05	0.05
min	0.30	0.00	0.15	(ref)	1.30	0.17	0.75			0.17				

sot1233\_po

Outline version	References				European projection	Issue date
	IEC	JEDEC	JEITA			
SOT1233		---				16-04-21 17-01-05

Figure 17. Package outline SOT1233 (X2SON8)

## 13 Abbreviations

Table 11. Abbreviations

Acronym	Description
CMOS	Complementary Metal-Oxide Semiconductor
DUT	Device Under Test
ESD	ElectroStatic Discharge
HBM	Human Body Model
MM	Machine Model
TTL	Transistor-Transistor Logic

## 14 Revision history

Table 12. Revision history

Document ID	Release date	Data sheet status	Change notice	Supersedes
74LVC2G32v.13	20170703	Product data sheet	-	74LVC2G32v.12
Modifications:	<ul style="list-style-type: none"> <li>The format of this data sheet has been redesigned to comply with the identity guidelines of Nexperia.</li> <li>Legal texts have been adapted to the new company name where appropriate.</li> <li>Type number 74LVC2G32GX (SOT1233 / X2SON8) added.</li> <li>Type number 74LVC2G32GD removed.</li> </ul>			
74LVC2G32v.12	20161215	Product data sheet	-	74LVC2G32v.11
Modifications:	<ul style="list-style-type: none"> <li><a href="#">Table 7</a>: The maximum limits for leakage current and supply current have changed.</li> </ul>			
74LVC2G32v.11	20130408	Product data sheet	-	74LVC2G32 v.10
Modifications:	<ul style="list-style-type: none"> <li>For type number 74LVC2G32GD XSON8U has changed to XSON8.</li> </ul>			
74LVC2G32 v.10	20120622	Product data sheet	-	74LVC2G32 v.9
Modifications:	<ul style="list-style-type: none"> <li>For type number 74LVC2G32GM the SOT code has changed to SOT902-2.</li> </ul>			
74LVC2G32 v.9	20111128	Product data sheet	-	74LVC2G32 v.8
Modifications:	<ul style="list-style-type: none"> <li>Legal pages updated.</li> </ul>			
74LVC2G32 v.8	20101110	Product data sheet	-	74LVC2G32 v.7
74LVC2G32 v.7	20080606	Product data sheet	-	74LVC2G32 v.6
74LVC2G32 v.6	20080227	Product data sheet	-	74LVC2G32 v.5
74LVC2G32 v.5	20070904	Product data sheet	-	74LVC2G32 v.4
74LVC2G32 v.4	20060515	Product data sheet	-	74LVC2G32 v.3
74LVC2G32 v.3	20050201	Product specification	-	74LVC2G32 v.2
74LVC2G32 v.2	20040922	Product specification	-	74LVC2G32 v.1
74LVC2G32 v.1	20031027	Product specification	-	-

## 15 Legal information

### 15.1 Data sheet status

Document status <sup>[1][2]</sup>	Product status <sup>[3]</sup>	Definition
Objective [short] data sheet	Development	This document contains data from the objective specification for product development.
Preliminary [short] data sheet	Qualification	This document contains data from the preliminary specification.
Product [short] data sheet	Production	This document contains the product specification.

[1] Please consult the most recently issued document before initiating or completing a design.

[2] The term 'short data sheet' is explained in section "Definitions".

[3] The product status of device(s) described in this document may have changed since this document was published and may differ in case of multiple devices. The latest product status information is available on the Internet at URL <http://www.nexperia.com>.

### 15.2 Definitions

**Draft** — The document is a draft version only. The content is still under internal review and subject to formal approval, which may result in modifications or additions. Nexperia does not give any representations or warranties as to the accuracy or completeness of information included herein and shall have no liability for the consequences of use of such information.

**Short data sheet** — A short data sheet is an extract from a full data sheet with the same product type number(s) and title. A short data sheet is intended for quick reference only and should not be relied upon to contain detailed and full information. For detailed and full information see the relevant full data sheet, which is available on request via the local Nexperia sales office. In case of any inconsistency or conflict with the short data sheet, the full data sheet shall prevail.

**Product specification** — The information and data provided in a Product data sheet shall define the specification of the product as agreed between Nexperia and its customer, unless Nexperia and customer have explicitly agreed otherwise in writing. In no event however, shall an agreement be valid in which the Nexperia product is deemed to offer functions and qualities beyond those described in the Product data sheet.

### 15.3 Disclaimers

**Limited warranty and liability** — Information in this document is believed to be accurate and reliable. However, Nexperia does not give any representations or warranties, expressed or implied, as to the accuracy or completeness of such information and shall have no liability for the consequences of use of such information. Nexperia takes no responsibility for the content in this document if provided by an information source outside of Nexperia. In no event shall Nexperia be liable for any indirect, incidental, punitive, special or consequential damages (including - without limitation - lost profits, lost savings, business interruption, costs related to the removal or replacement of any products or rework charges) whether or not such damages are based on tort (including negligence), warranty, breach of contract or any other legal theory. Notwithstanding any damages that customer might incur for any reason whatsoever, Nexperia's aggregate and cumulative liability towards customer for the products described herein shall be limited in accordance with the Terms and conditions of commercial sale of Nexperia.

**Right to make changes** — Nexperia reserves the right to make changes to information published in this document, including without limitation specifications and product descriptions, at any time and without notice. This document supersedes and replaces all information supplied prior to the publication hereof.

**Suitability for use** — Nexperia products are not designed, authorized or warranted to be suitable for use in life support, life-critical or safety-critical

systems or equipment, nor in applications where failure or malfunction of an Nexperia product can reasonably be expected to result in personal injury, death or severe property or environmental damage. Nexperia and its suppliers accept no liability for inclusion and/or use of Nexperia products in such equipment or applications and therefore such inclusion and/or use is at the customer's own risk.

**Applications** — Applications that are described herein for any of these products are for illustrative purposes only. Nexperia makes no representation or warranty that such applications will be suitable for the specified use without further testing or modification. Customers are responsible for the design and operation of their applications and products using Nexperia products, and Nexperia accepts no liability for any assistance with applications or customer product design. It is customer's sole responsibility to determine whether the Nexperia product is suitable and fit for the customer's applications and products planned, as well as for the planned application and use of customer's third party customer(s). Customers should provide appropriate design and operating safeguards to minimize the risks associated with their applications and products. Nexperia does not accept any liability related to any default, damage, costs or problem which is based on any weakness or default in the customer's applications or products, or the application or use by customer's third party customer(s). Customer is responsible for doing all necessary testing for the customer's applications and products using Nexperia products in order to avoid a default of the applications and the products or of the application or use by customer's third party customer(s). Nexperia does not accept any liability in this respect.

**Limiting values** — Stress above one or more limiting values (as defined in the Absolute Maximum Ratings System of IEC 60134) will cause permanent damage to the device. Limiting values are stress ratings only and (proper) operation of the device at these or any other conditions above those given in the Recommended operating conditions section (if present) or the Characteristics sections of this document is not warranted. Constant or repeated exposure to limiting values will permanently and irreversibly affect the quality and reliability of the device.

**Terms and conditions of commercial sale** — Nexperia products are sold subject to the general terms and conditions of commercial sale, as published at <http://www.nexperia.com/profile/terms>, unless otherwise agreed in a valid written individual agreement. In case an individual agreement is concluded only the terms and conditions of the respective agreement shall apply. Nexperia hereby expressly objects to applying the customer's general terms and conditions with regard to the purchase of Nexperia products by customer.

**No offer to sell or license** — Nothing in this document may be interpreted or construed as an offer to sell products that is open for acceptance or the grant, conveyance or implication of any license under any copyrights, patents or other industrial or intellectual property rights.

**Export control** — This document as well as the item(s) described herein may be subject to export control regulations. Export might require a prior authorization from competent authorities.

**Non-automotive qualified products** — Unless this data sheet expressly states that this specific Nexperia product is automotive qualified, the product is not suitable for automotive use. It is neither qualified nor tested in accordance with automotive testing or application requirements. Nexperia accepts no liability for inclusion and/or use of non-automotive qualified products in automotive equipment or applications. In the event that customer uses the product for design-in and use in automotive applications to automotive specifications and standards, customer (a) shall use the product without Nexperia's warranty of the product for such automotive applications, use and specifications, and (b) whenever customer uses the product for automotive applications beyond Nexperia's specifications such use shall be solely at customer's own risk, and (c) customer fully indemnifies Nexperia for any liability, damages or failed product claims resulting from customer

design and use of the product for automotive applications beyond Nexperia's standard warranty and Nexperia's product specifications.

**Translations** — A non-English (translated) version of a document is for reference only. The English version shall prevail in case of any discrepancy between the translated and English versions.

## 15.4 Trademarks

Notice: All referenced brands, product names, service names and trademarks are the property of their respective owners.

## Contents

1	General description .....	1
2	Features and benefits .....	1
3	Ordering information .....	1
4	Marking .....	2
5	Functional diagram .....	3
6	Pinning information .....	3
6.1	Pinning .....	3
6.2	Pin description .....	4
7	Functional description .....	4
8	Limiting values .....	5
9	Recommended operating conditions .....	5
10	Static characteristics .....	6
11	Dynamic characteristics .....	8
11.1	Waveforms and test circuit .....	8
12	Package outline .....	10
13	Abbreviations .....	18
14	Revision history .....	18
15	Legal information .....	19

---

Please be aware that important notices concerning this document and the product(s) described herein, have been included in section 'Legal information'.

---

© Nexperia B.V. 2017.

All rights reserved.

For more information, please visit: <http://www.nexperia.com>

For sales office addresses, please send an email to: [salesaddresses@nexperia.com](mailto:salesaddresses@nexperia.com)

Date of release: 3 July 2017

Document identifier: 74LVC2G32