











1T8A_3.5P series

1W - Single Output DC-DC Converter - Fixed Input - Isolated & Unregulated

DC-DC Converter 1 Watt

-  Miniature SMD package
-  3500VDC isolation
-  Operating temperature range: -50°C ~ +125°C
-  Components meet AEC-Q100 standards
-  Internal SMD construction
-  The production process meet TS16949 system requirements
-  Industry standard pinout
-  Short circuit protection (SCP)



Common specifications	
Short circuit protection*:	Continuous, automatic recovery
Temperature rise at full load:	25°C MAX (Ta= 25°C, 100% load)
Cooling:	Free air convection
Operation temperature range:	-50°C~+125°C
Storage temperature range:	-55°C ~+135°C
Lead temperature	300°C MAX, 1.5mm from case for 10 sec
Storage humidity range:	< 95%
Package material:	Epoxy Resin [UL94-V0]
MTBF (MIL-HDBK-217F@25°C):	>3,500,000 hours
Weight:	1.5g

*Supply voltage must be discontinued at the end of short circuit duration.

Input specifications					
Item	Test condition	Min	Typ	Max	Units
Input surge voltage (1 sec. max.)	5VDC input	-0.7		9	VDC
Input filter	Capacitor				

Isolation specifications					
Item	Test condition	Min	Typ	Max	Units
Isolation voltage	Tested for 1 minute, leakage current less than 1 mA	3500			VDC
Isolation resistance	Test at 500VDC	1000			MΩ
Isolation capacitance	Input/Output 100KHz/0.1V		20		pF

Note:

1. Operation under minimum load will not damage the converter; However, they may not meet all specifications.
2. Max. Capacitive Load is tested at nominal input voltage and full load.
3. Unless otherwise noted, All specifications are measured at Ta=25°C, humidity<75%, nominal input voltage and rated output load.
4. In this datasheet, all test methods are based on our corporate standards.
5. All characteristics are for listed models, and non-standard models may perform differently. Please contact our technical support for more detail.
6. Please contact our technical support for any specific requirement.
7. Specifications of this product are subject to changes without prior notice.

The 1T8A_3.5P Series is specially designed for applications where isolated output is required from a distributed power system. It can be used in automobile motor control and drive systems.

These products apply to:

- 1) Where the voltage of the input power supply is fixed (voltage variation $\leq \pm 10\%$)
- 2) Where isolation is necessary between input and output (isolation voltage $\leq 3500\text{VDC}$)
- 3) Where the regulation of the output voltage and the output ripple noise are not demanding

Such as: motor vehicle communication system controller, engine control systems, the ignition system, the motor voltage monitoring, the electronic accelerator pedal, automobile tire pressure detection system, doors and tail lights controller, air conditioning control and battery management system (BMS), etc.

Example:	
1T8A_0505S3.5UP	
1= 1Watt; T8= SMT8; A=Pinning; 5Vin; 5Vout; S=Single output; 3.5= 3.5kVDC; U= Unregulated output; P= Short circuit protection	

Output specifications					
Item	Test condition	Min	Typ	Max	Units
Output power		0.1		1	W
Line regulation	For Vin change of 1%			± 1.2	%
Load regulation	10% to 100% load		12		%
Output voltage accuracy	See tolerance envelope graph				
Temperature drift	100% full load			± 0.03	%/°C
Ripple & Noise*	20MHz Bandwidth		60		mVp-p
Switching frequency	Full load, nominal input		100	300	KHz

*Test ripple and noise by "parallel cable" method. See detailed operation instructions at DC-DC application notes.

EMC specifications			
EMI	CE	CISPR25/EN55025 CLASS 1 (External Circuit Refer to EMC recommended circuit)	
ESD	ESD	ISO10605 perf. Criteria B	Contact $\pm 6\text{KV}$

1T8A_3.5P series

1W - Single Output DC-DC Converter - Fixed Input - Isolated & Unregulated

Part Number	Input Voltage [VDC]		Output Voltage [VDC]	Output Current [mA]		Capacitive load [μ F, max.]	Input Current [mA]		Reflected ripple current [mA, Typ.]	Efficiency [%, Typ.]
	Nominal	Range		Max	Min		Max	Min		
1T8A_0505S3.SUP	5	4.5-5.5	5	200	20	220	267	20	15	85

EMC recommended circuit

EMI recommended external circuit (Class B):

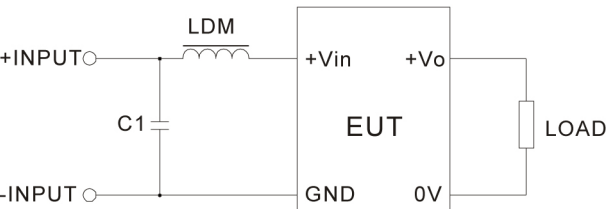

Recommended external circuit parameters:

VIN (V)		5
EMI	C1	10 μ F
	LDM	12 μ H

EMI test waveform (class B application circuit)

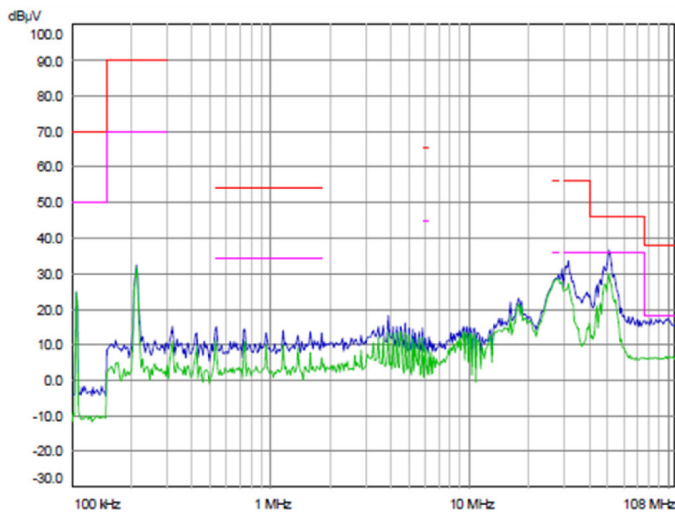

1T8A_0505S3.SUP (positive line)

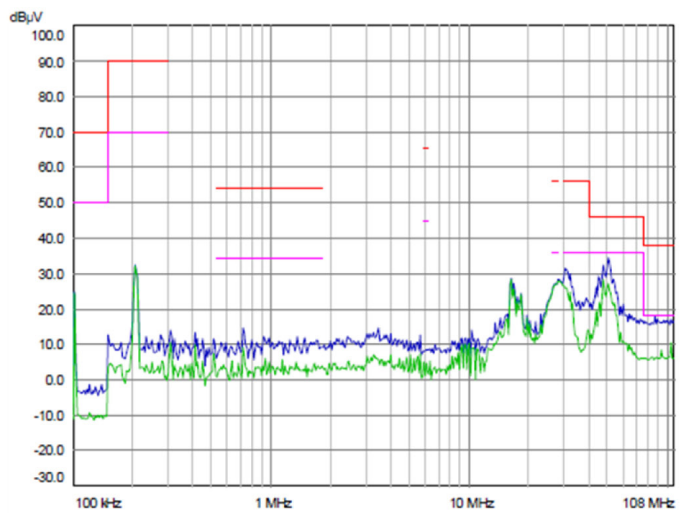

1T8A_0505S3.SUP (negative line)

Typical characteristics

Tolerance Envelope Curve

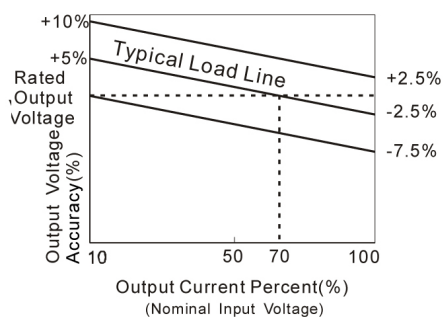

Temperature Derating Graph

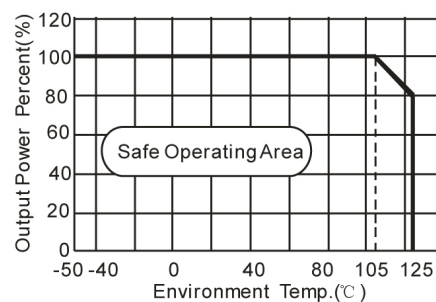

1T8A_3.5P series

1W - Single Output DC-DC Converter - Fixed Input - Isolated & Unregulated

Efficiency

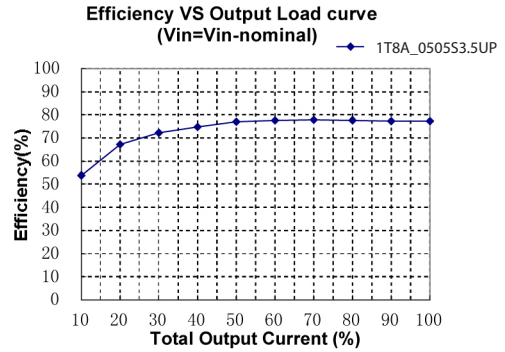
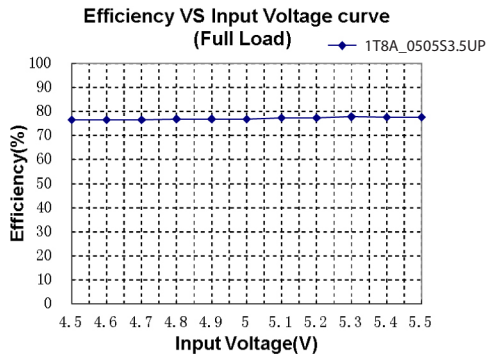

Recommended reflow soldering profile

Recommended reflow soldering profile refer to IPC/JEDEC J-STD-020D standard, our products recommended reflow soldering profile as follows:

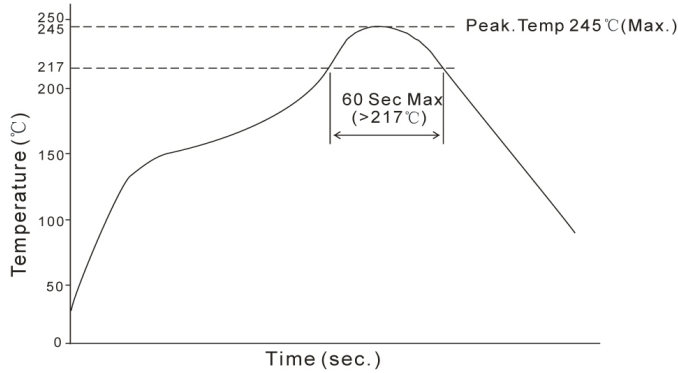

Mechanical dimensions

Recommended footprint

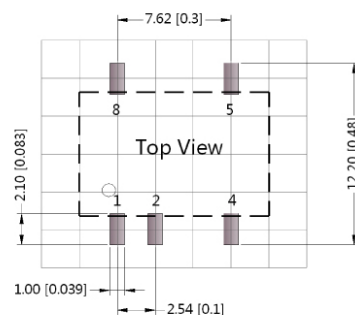
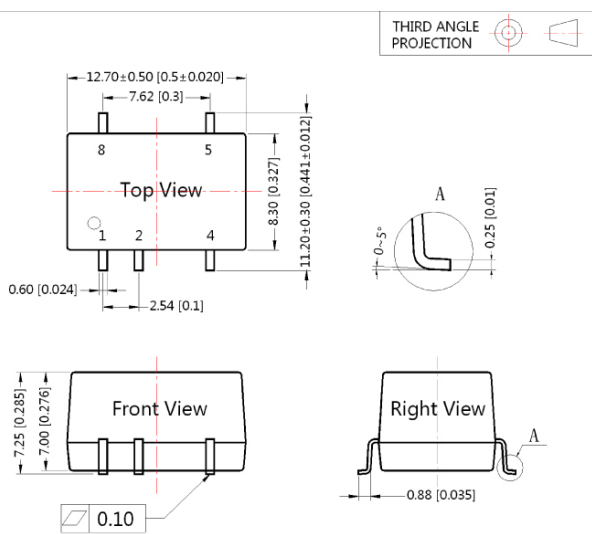

Note: Grid 2.54*2.54mm

PIN CONNECTION	
Pin	Function
1	GND
2	Vin
4	0V
5	+Vo
8	NC

NC: No Connection

Note:
Unit: mm[inch]
Pin section tolerances: 0.10mm[0.004inch]
General tolerances: 0.25mm[0.010inch]

1T8A_3.5P series

1W - Single Output DC-DC Converter - Fixed Input - Isolated & Unregulated

Tube outline Test configurations

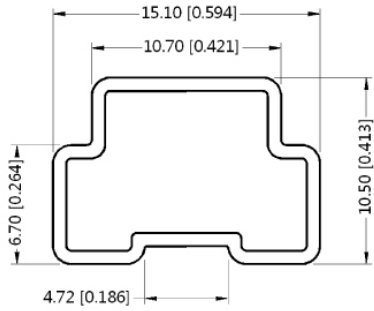

Note:
Unit: mm[inch]
General tolerances: 0.5mm[0.020inch]

L=530mm[20.866inch]
Devices per tube quantity: 40pcs

L=220mm[8.661inch]
Devices per tube quantity: 15pcs

Input Reflected-Ripple Current Test Setup
Input reflected-ripple current is measured with an inductor L_{in} and Capacitor C_{in} to simulate the source impedance.

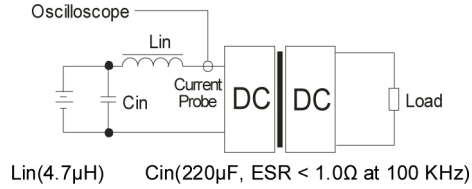

Application note

1) Requirement on output load
To ensure this module can operate efficiently and reliably, During operation, the minimum output load could not be less than 10% of the full load. If the actual output power is very small, please connect a resistor with proper resistance at the output end in parallel to increase the load.

2) Recommended circuit
If you want to further decrease the input/output ripple, an capacitor filtering network may be connected to the input and output ends of the DC/DC converter, see (Figure 1).



Figure 1

It should also be noted that the capacitance of filter capacitor must be proper. If the capacitance is too big, a startup problem might arise. For every channel of output, provided the safe and reliable operation is ensured, the recommended capacitance of its filter capacitor sees (Table 1).

V_{in} (VDC)	C_{in} (μF)	V_o (VDC)	C_{out} (μF)
5	4.7	5	10

It's not recommended to connect any external capacitor in the application field with less than 0.5 watt output. Table 1

3) Overload Protection
Under normal operating conditions, the output circuit of these products has no protection against overload. The simplest method is to add a circuit breaker to the circuit.

4) Output Voltage Regulation and Over-voltage Protection Circuit
The simplest device for output voltage regulation, over-voltage and over-current protection is a linear regulator with overheat protection which is connected to the input or output in series (Figure 2) and an capacitor filtering network.the recommended capacitance of the capacitor refer to Table 1, linear regulator based on the actual voltage and current to make a reasonable selection.

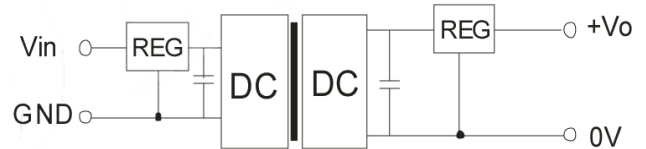

Figure 2

5) It is not recommended to increase the output power capability by connecting two or more converters in parallel. The product is not hot-swappable.