

***TPS54980EVM-022 9-Amp,
SWIFT™ Regulator
Evaluation Module***

User's Guide

IMPORTANT NOTICE

Texas Instruments Incorporated and its subsidiaries (TI) reserve the right to make corrections, modifications, enhancements, improvements, and other changes to its products and services at any time and to discontinue any product or service without notice. Customers should obtain the latest relevant information before placing orders and should verify that such information is current and complete. All products are sold subject to TI's terms and conditions of sale supplied at the time of order acknowledgment.

TI warrants performance of its hardware products to the specifications applicable at the time of sale in accordance with TI's standard warranty. Testing and other quality control techniques are used to the extent TI deems necessary to support this warranty. Except where mandated by government requirements, testing of all parameters of each product is not necessarily performed.

TI assumes no liability for applications assistance or customer product design. Customers are responsible for their products and applications using TI components. To minimize the risks associated with customer products and applications, customers should provide adequate design and operating safeguards.

TI does not warrant or represent that any license, either express or implied, is granted under any TI patent right, copyright, mask work right, or other TI intellectual property right relating to any combination, machine, or process in which TI products or services are used. Information published by TI regarding third-party products or services does not constitute a license from TI to use such products or services or a warranty or endorsement thereof. Use of such information may require a license from a third party under the patents or other intellectual property of the third party, or a license from TI under the patents or other intellectual property of TI.

Reproduction of information in TI data books or data sheets is permissible only if reproduction is without alteration and is accompanied by all associated warranties, conditions, limitations, and notices. Reproduction of this information with alteration is an unfair and deceptive business practice. TI is not responsible or liable for such altered documentation.

Resale of TI products or services with statements different from or beyond the parameters stated by TI for that product or service voids all express and any implied warranties for the associated TI product or service and is an unfair and deceptive business practice. TI is not responsible or liable for any such statements.

Following are URLs where you can obtain information on other Texas Instruments products & application solutions:

Products		Applications	
Amplifiers	amplifier.ti.com	Audio	www.ti.com/audio
Data Converters	dataconverter.ti.com	Automotive	www.ti.com/automotive
DSP	dsp.ti.com	Broadband	www.ti.com/broadband
Interface	interface.ti.com	Digital Control	www.ti.com/digitalcontrol
Logic	logic.ti.com	Military	www.ti.com/military
Power Mgmt	power.ti.com	Optical Networking	www.ti.com/opticalnetwork
Microcontrollers	microcontroller.ti.com	Security	www.ti.com/security
		Telephony	www.ti.com/telephony
		Video & Imaging	www.ti.com/video
		Wireless	www.ti.com/wireless

Mailing Address: Texas Instruments
Post Office Box 655303 Dallas, Texas 75265

EVM IMPORTANT NOTICE

Texas Instruments (TI) provides the enclosed product(s) under the following conditions:

This evaluation kit being sold by TI is intended for use for **ENGINEERING DEVELOPMENT OR EVALUATION PURPOSES ONLY** and is not considered by TI to be fit for commercial use. As such, the goods being provided may not be complete in terms of required design-, marketing-, and/or manufacturing-related protective considerations, including product safety measures typically found in the end product incorporating the goods. As a prototype, this product does not fall within the scope of the European Union directive on electromagnetic compatibility and therefore may not meet the technical requirements of the directive.

Should this evaluation kit not meet the specifications indicated in the EVM User's Guide, the kit may be returned within 30 days from the date of delivery for a full refund. **THE FOREGOING WARRANTY IS THE EXCLUSIVE WARRANTY MADE BY SELLER TO BUYER AND IS IN LIEU OF ALL OTHER WARRANTIES, EXPRESSED, IMPLIED, OR STATUTORY, INCLUDING ANY WARRANTY OF MERCHANTABILITY OR FITNESS FOR ANY PARTICULAR PURPOSE.**

The user assumes all responsibility and liability for proper and safe handling of the goods. Further, the user indemnifies TI from all claims arising from the handling or use of the goods. Please be aware that the products received may not be regulatory compliant or agency certified (FCC, UL, CE, etc.). Due to the open construction of the product, it is the user's responsibility to take any and all appropriate precautions with regard to electrostatic discharge.

EXCEPT TO THE EXTENT OF THE INDEMNITY SET FORTH ABOVE, NEITHER PARTY SHALL BE LIABLE TO THE OTHER FOR ANY INDIRECT, SPECIAL, INCIDENTAL, OR CONSEQUENTIAL DAMAGES.

TI currently deals with a variety of customers for products, and therefore our arrangement with the user **is not exclusive**.

TI assumes **no liability for applications assistance, customer product design, software performance, or infringement of patents or services described herein**.

Please read the EVM User's Guide and, specifically, the EVM Warnings and Restrictions notice in the EVM User's Guide prior to handling the product. This notice contains important safety information about temperatures and voltages. For further safety concerns, please contact the TI application engineer.

Persons handling the product must have electronics training and observe good laboratory practice standards.

No license is granted under any patent right or other intellectual property right of TI covering or relating to any machine, process, or combination in which such TI products or services might be or are used.

Mailing Address:

Texas Instruments
Post Office Box 655303
Dallas, Texas 75265

EVM WARNINGS AND RESTRICTIONS

It is important to operate this EVM within the input and output voltage ranges specified in the EVM User's Guide.

Exceeding the specified input range may cause unexpected operation and/or irreversible damage to the EVM. If there are questions concerning the input range, please contact a TI field representative prior to connecting the input power.

Applying loads outside of the specified output range may result in unintended operation and/or possible permanent damage to the EVM. Please consult the EVM User's Guide prior to connecting any load to the EVM output. If there is uncertainty as to the load specification, please contact a TI field representative.

During normal operation, some circuit components may have case temperatures greater than 55°C. The EVM is designed to operate properly with certain components above 60°C as long as the input and output ranges are maintained. These components include but are not limited to linear regulators, switching transistors, pass transistors, and current sense resistors. These types of devices can be identified using the EVM schematic located in the EVM User's Guide. When placing measurement probes near these devices during operation, please be aware that these devices may be very warm to the touch.

Mailing Address:

Texas Instruments
Post Office Box 655303
Dallas, Texas 75265

Contents

1	Introduction	1-1
1.1	Background	1-2
1.2	Performance Specification Summary	1-3
1.3	Modifications	1-4
1.3.1	Changing Output Voltage	1-4
1.3.2	Switching Frequency	1-4
1.3.3	Power Sequencing	1-5
2	Test Setup and Results	2-1
2.1	Input/Output Connections	2-2
2.2	Efficiency	2-3
2.3	Power Dissipation	2-4
2.4	Output Voltage Regulation	2-5
2.5	Load Transients	2-6
2.6	Loop Characteristics	2-6
2.7	Output Voltage Ripple	2-7
2.8	Input Voltage Ripple	2-8
2.9	Power Up and Down	2-9
3	Board Layout	3-1
3.1	Layout	3-2
4	Schematic and Bill of Materials	4-1
4.1	Schematic	4-2
4.2	Bill of Materials	4-3

Figures

1-1	Frequency Trimming Resistor Selection Graph	1-5
2-1	Connection Diagram	2-2
2-2	Measured Efficiency, TPS54980	2-3
2-3	Measured Circuit Losses	2-4
2-4	Load Regulation	2-5
2-5	Line Regulation	2-5
2-6	Load Transient Response, TPS54980	2-6
2-7	Measured Loop Response, TPS54980, $V_I = 3\text{ V}$	2-6
2-8	Measured Loop Response, TPS54980, $V_I = 4\text{ V}$	2-7
2-9	Measured Output Voltage Ripple, TPS54980	2-7
2-10	Input Voltage Ripple, TPS54980	2-8
2-11	Power Up with Tracking	2-9
2-12	Power Down With Tracking	2-10
2-13	Power Up With Ratiometric Sequencing	2-10
2-14	Power Down With Ratiometric Sequencing	2-11
2-15	Power Up With Core Voltage Rising First	2-11
2-16	Power Up With Core Voltage Falling Second	2-12
3-1	Top-Side Layout	3-2
3-2	Internal Layer 2	3-3
3-3	Internal Layer 3	3-3
3-4	Bottom Side Layout (looking from top side)	3-4
3-5	Top Side Assembly	3-4
4-1	TPS54980EVM-022 Schematic	4-2

Tables

1-1	Input Voltage and Output Current Summary	1-2
1-2	TPS54980EVM-022 Performance Specification Summary	1-3
1-3	Output Voltage Programming	1-4
4-1	TPS54980EVM-022 Bill of Materials	4-3

Read This First

About This Manual

This user's guide describes the characteristics, operation, and the use of the TPS54980EVM-022 evaluation module. It covers all pertinent areas involved to properly use this EVM board along with the devices that it supports. The physical PCB layout, schematic diagram, and circuit descriptions are included.

How to Use This Manual

This document contains the following chapters:

- Chapter 1—Introduction
- Chapter 2—Test Setup and Results
- Chapter 3—Board Layout
- Chapter 4—Schematic and Bill of Materials

FCC Warning

This equipment is intended for use in a laboratory test environment only. It generates, uses, and can radiate radio frequency energy and has not been tested for compliance with the limits of computing devices pursuant to subpart J of part 15 of FCC rules, which are designed to provide reasonable protection against radio frequency interference. Operation of this equipment in other environments may cause interference with radio communications, in which case the user at his own expense will be required to take whatever measures may be required to correct this interference.

Trademarks

- SWIFT and PowerPAD are trademarks of Texas Instruments.



Introduction

This chapter contains background information for the TPS54980 as well as support documentation for the TPS54980EVM-022 evaluation module (HPA022). The TPS54980EVM-022 performance specifications are given, as well as modifications.

Topic	Page
1.1 Background	1-2
1.2 Performance Specification Summary	1-3
1.3 Modifications	1-4

1.1 Background

The TPS54980 tracking dc/dc converter is designed to provide accurate power sequencing in applications where two or more voltages are required for a load. These types of applications include core and I/O power supplies for microprocessors, DSPs, and FPGAs. Typically, some specific relation between the core and I/O supply voltages has to be provided during the power up and power down sequences. The TPS54980 tracking dc/dc converter is capable of direct tracking, ratiometric tracking, and voltage sequencing with a second power source.

The TPS54980EVM-022 is a two-channel EVM demonstrating the flexibility inherent in the TPS54980 design for tracking and sequencing core and I/O voltages. The TPS54980 is used to generate the core voltage and is nominally set at 1.8 V. The nominal 3.3-V I/O voltage is provided by a TPS2013 distribution switch. Rated input voltage and output current range are listed in Table 1-1.

Table 1-1. Input Voltage and Output Current Summary

EVM	Input Voltage Range	Output Current Range
TPS54980EVM-022	3.0 V to 4.0 V	Core, -9 A to 9 A
		I/O, 0 to 1.5 A

This evaluation module is designed to demonstrate the small PCB areas that may be achieved when designing with the TPS54980 regulator. The switching frequency is set at a nominal 700 kHz, allowing the use of a small footprint 0.65- μ H output inductor.

The MOSFETs of the TPS54980 are incorporated inside the TPS54980 package. This eliminates the need for external MOSFETs and their associated drivers. The low drain-to-source on resistance of the MOSFETs provides the TPS54980 high efficiency and helps to keep the junction temperature low at high output currents. The compensation components are provided external to the IC and allow for an adjustable output voltage and a customizable loop response.

The TPS54980 device uses the TRACKIN pin to access the tracking and sequencing capabilities. An internal multiplexer circuit compares the voltage at this pin with the internal reference voltage and uses the lesser of the two as the reference for the output voltage regulation. When the output of another power supply or distribution switch is connected to the TRACKIN pin of the TPS54980, the output of the TPS54980 tracks the output of this other channel during power up or power down, until the voltage at the TRACKIN pin becomes higher than the internal reference voltage. By applying the other power supply output to the TRACKIN pin through an appropriate resistor divider network, any required power up and power down relation between the two output voltages of the regulators can be set by changing the ratio of the divider network.

1.2 Performance Specification Summary

A summary of the TPS54980EVM-022 performance specifications is provided in Table 1–2. Specifications are given for an input voltage of 3.3 V and an output voltage of 1.8 V unless otherwise specified. The ambient temperature is 25°C for all measurements, unless otherwise noted. The data presented in Table 1–2 was compiled with no load on the I/O output. The maximum input voltage for the TPS54980 is 4 V.

Table 1–2. TPS54980EVM-022 Performance Specification Summary

Parameters		Test Conditions	Min	Typ	Max	Units
Input voltage range			3.0	3.3	4.0	V
Output voltage set point				1.8		V
Output current range		$V_I = 3$ to 5.5 V	–9		9	A
Line regulation		$I_O = 0$ A to 3 A, $V_I = 3$ V to 5.5 V	±0.1%			
Load regulation		$V_I = 3.3$ V, $I_O = 0$ to 3 A	±0.2%			
Load transient response	Voltage change	$I_O = 2.25$ A to 6.75 A	–50			mV _{PK}
	Recovery time		400			μs
	Voltage change	$I_O = 6.75$ A to 2.25 A	50			mV _{PK}
	Recovery time		400			μs
Loop bandwidth		$V_I = 3$ V		63		kHz
Phase margin		$V_I = 3$ V		56		°
Loop bandwidth		$V_I = 4$ V		75		kHz
Phase margin		$V_I = 4$ V		49		°
Input ripple voltage				50	200	mV _{PP}
Output ripple voltage				6	10	mV _{PP}
Output rise time				N/A		ms
Operating frequency			280	700	700	kHz
Max efficiency		$V_I = 3.3$ V, $V_O = 1.8$ V, $I_O = 1.0$ A	89%			

1.3 Modifications

The TPS54980EVM-022 is designed to demonstrate the small size that can be attained when designing with the TPS54980, however many of the features, which allow for extensive modifications, have been omitted from this EVM.

1.3.1 Changing Output Voltage

By changing the value of R_2 , the output voltage can be set to a value in the range of 0.9 V to 2.5 V. The value of R_2 for a specific output voltage can be calculated by using Equation 1–1. Table 1–3 lists the values for R_2 for some common output voltages.

Equation 1–1.

$$R_2 = 10 \text{ k}\Omega \times \frac{0.891 \text{ V}}{V_O - 0.891 \text{ V}}$$

Table 1–3. Output Voltage Programming

Output Voltage (V)	R_2 Value (k Ω)
0.9	1000
1.2	28.7
1.5	14.7
1.8	9.76
2.5	5.49

The minimum output voltage is limited by the minimum controllable on-time of the device, 200 ns, and is dependent upon the duty cycle and operating frequency. The approximate minimum output voltage can be calculated using Equation 1–2:

Equation 1–2.

$$V_{\text{OUTMIN}} = 200 \text{ nsec} \times f_S \times V_{\text{INMAX}}$$

1.3.2 Switching Frequency

Switching frequency can be trimmed to any value between 280 kHz and 700 kHz by changing the value of R_4 . Decreasing the switching frequency results in increased output ripple unless the value of L_1 is increased. A plot of the value of R_T versus the switching frequency is shown in Figure 1–1.

Figure 1-1. Frequency Trimming Resistor Selection Graph

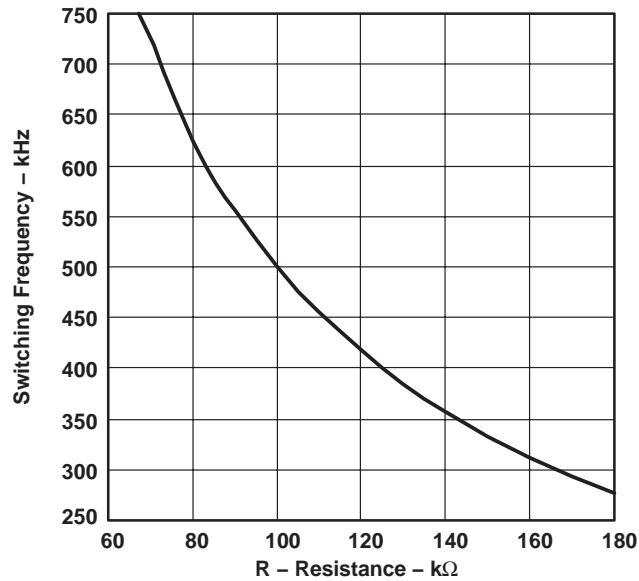

An onboard electrolytic input capacitor may be added at C1.

1.3.3 Power Sequencing

By selecting different R6–R7 resistor divider ratios, different power sequencing scenarios can be set. The Equations 1-3, 1-4, and 1-5 show how to select the different ways of power sequencing.

Equation 1-3.

$$\frac{R6}{R7} = \frac{R1}{R2} - \text{Core voltage tracks I/O voltage}$$

Equation 1-4.

$$\frac{R6}{R7} = \frac{(V_{I/O} - 0.891)}{0.891} - \text{Ratiometric relation between core and I/O voltage}$$

Equation 1-5.

$$\frac{R6}{R7} < \frac{R1}{R2} - \text{Core voltage rises first at power up and falls second at power down}$$



Test Setup and Results

This chapter describes how to properly connect, setup, and use the TPS54980EVM-022 evaluation module. The chapter also includes test results typical for the TPS54980EVM-022 and covers efficiency, output voltage regulation, load transients, loop response, output ripple, input ripple, and startup.

Topic	Page
2.1 Input/Output Connections	2-2
2.2 Efficiency	2-3
2.3 Power Dissipation	2-4
2.4 Output Voltage Regulation	2-5
2.5 Load Transients	2-6
2.6 Loop Characteristics	2-6
2.7 Output Voltage Ripple	2-7
2.8 Input Voltage Ripple	2-8
2.9 Power Up and Down	2-9

2.1 Input/Output Connections

The TPS54980EVM-022 has the following three input/output connectors: VIN J1, VOUT I/O J2, and VOUT CORE J3. A diagram showing the connection points is shown in Figure 2-1. A power supply capable of supplying 8 A should be connected to J1 through a pair of 20 AWG wires. The load should be connected to J2 through a pair of 16 AWG wires. The maximum load current capability should be 9 A. Wire lengths should be minimized to reduce losses in the wires. Test point TP7 provides a place to easily connect an oscilloscope voltage probe to monitor the output voltage. The TPS54980 is intended to be used as a point of load regulator. In typical applications it is usually located close to the input voltage source. When using the TPS54980EVM-022 with an external power supply as the source for VIN, an additional bulk capacitor may be required, depending upon the output impedance of the source and length of the hook-up wires. The test results presented were obtained using an additional 470- μ F, 16-V input capacitor. Alternately, C1 may be populated with an input filter capacitor. Connection is shown for no load on the I/O voltage output. The I/O voltage may supply up to 1.5 A into an external load.

Figure 2-1. Connection Diagram

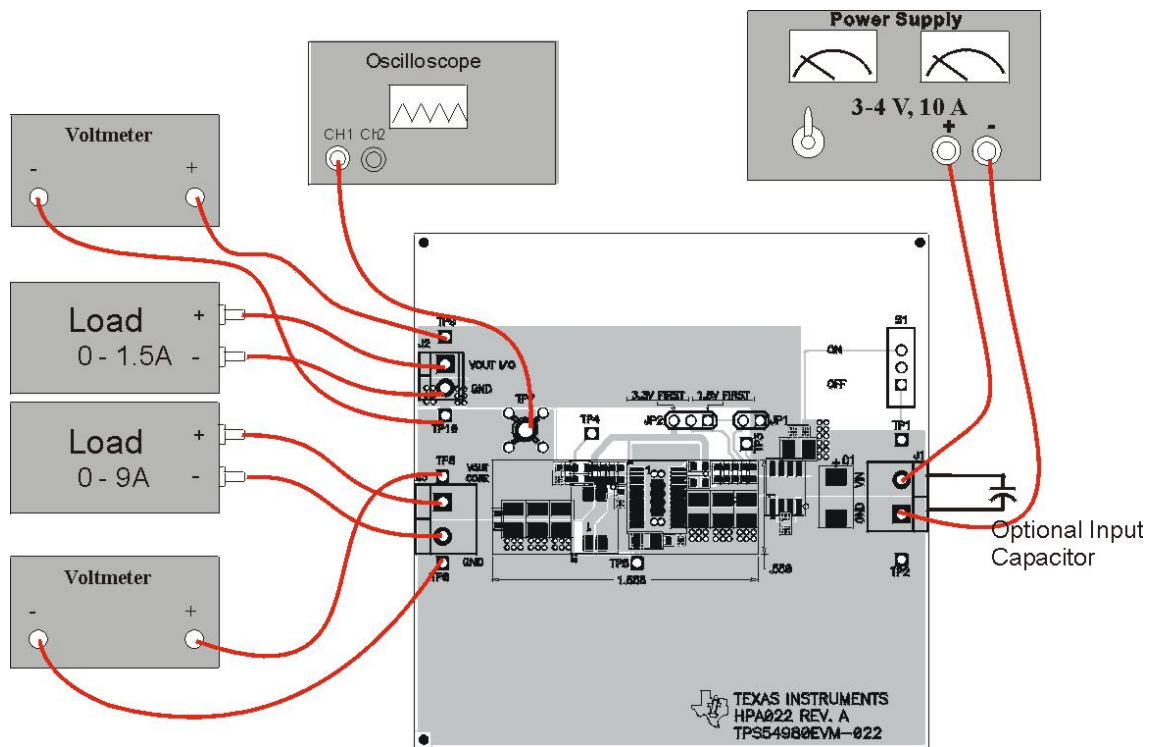

2.2 Efficiency

The TPS54980EVM-022 efficiency peaks at a load current of about 1 A to 2 A and then decreases as the load current increases towards full load. Figure 2-2 shows the efficiency of the TPS54980 at an ambient temperature of 25°C. The efficiency is lower at higher ambient temperatures due to temperature variation in the drain-to-source resistance of the MOSFETs. Efficiency is slightly lower at 700 kHz than at lower switching frequencies due to the gate and switching losses in the MOSFETs.

Figure 2-2. Measured Efficiency, TPS54980

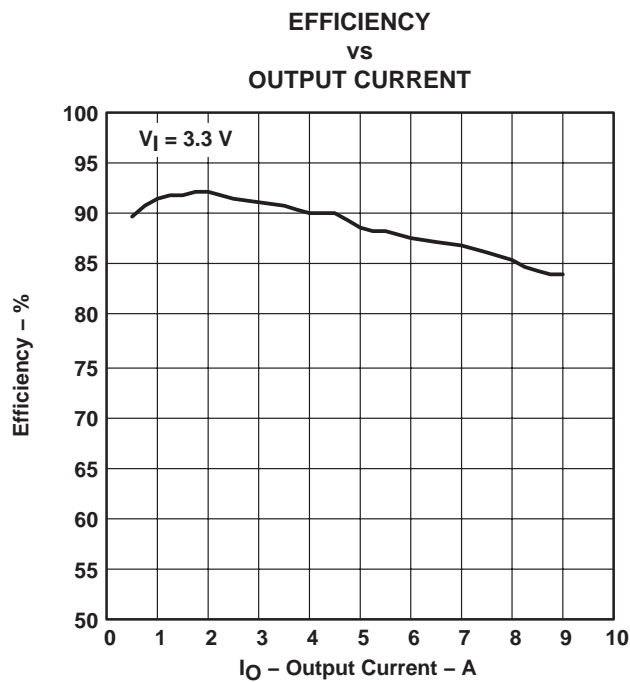

2.3 Power Dissipation

The low junction-to-case thermal resistance of the PWP package, along with well designed board layout, allows the TPS54980EVM-022 EVM to output full rated load current while maintaining safe junction temperatures. With a 3.3-V input source and a 9-A load, the junction temperature is approximately 60°C, while the case temperature is approximately 55°C. The total circuit losses at 25°C are shown in Figure 2–3. Power dissipation is shown for an input voltage of 3.3 V. For additional information on the dissipation ratings of the devices, see the individual product data sheets.

Figure 2–3. Measured Circuit Losses

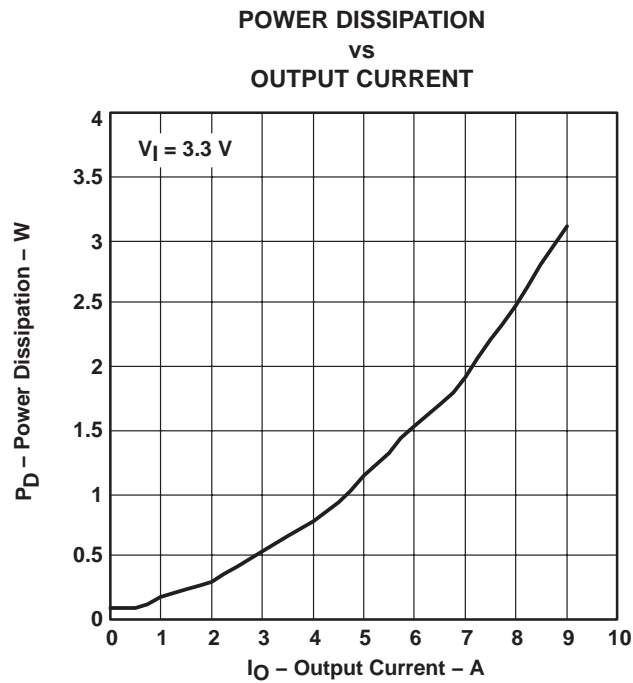

2.4 Output Voltage Regulation

The output voltage load regulation of the TPS54980EVM-022 is shown in Figure 2-4, while the output voltage line regulation is shown in Figure 2-5. Measurements are shown for an ambient temperature of 25°C.

Figure 2-4. Load Regulation

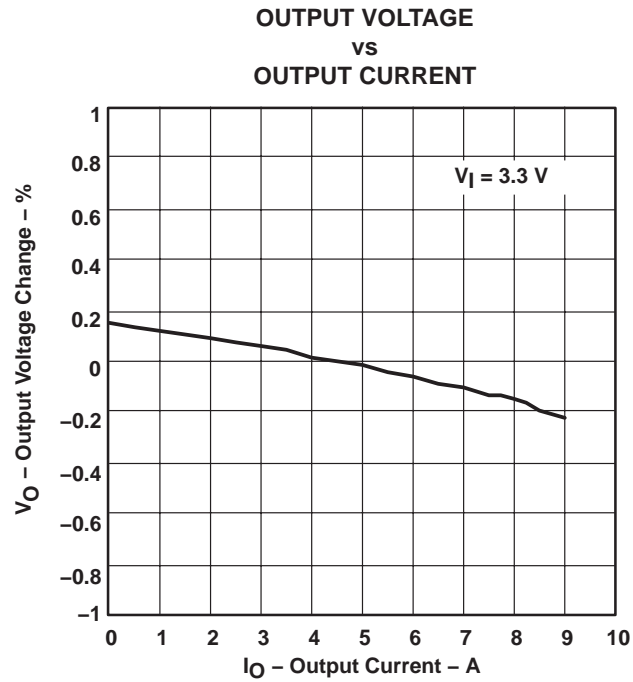
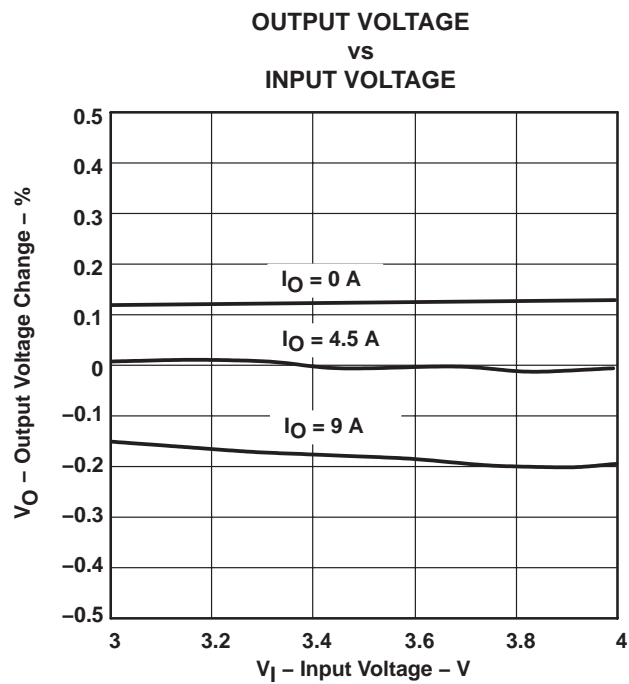

Figure 2-5. Line Regulation



2.5 Load Transients

The TPS54980EVM-022 response to load transients is shown in Figure 2-6. The current step is from 25 to 75 percent of maximum rated load. Total peak-to-peak voltage variation is as shown, including ripple and noise on the output.

Figure 2-6. Load Transient Response, TPS54980

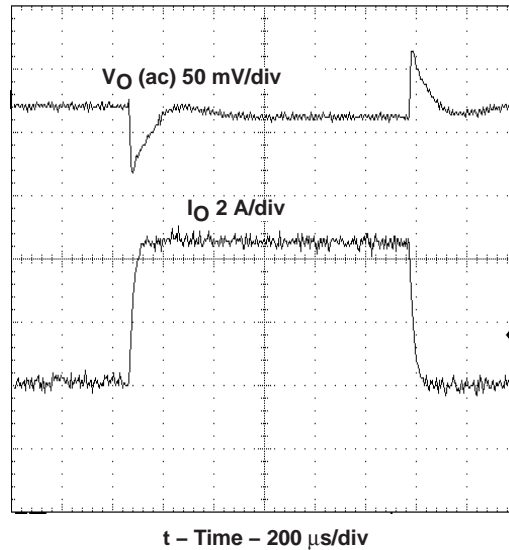

2.6 Loop Characteristics

The TPS54980EVM-022 loop response characteristics are shown in Figure 2-7 and Figure 2-8. Gain and phase plots are shown for each device at minimum and maximum operating voltage.

Figure 2-7. Measured Loop Response, TPS54980, $V_I = 3V$

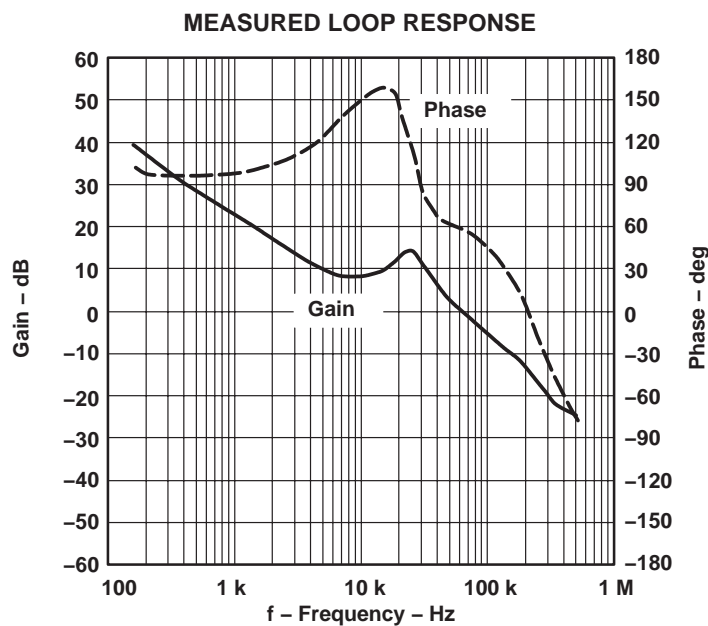
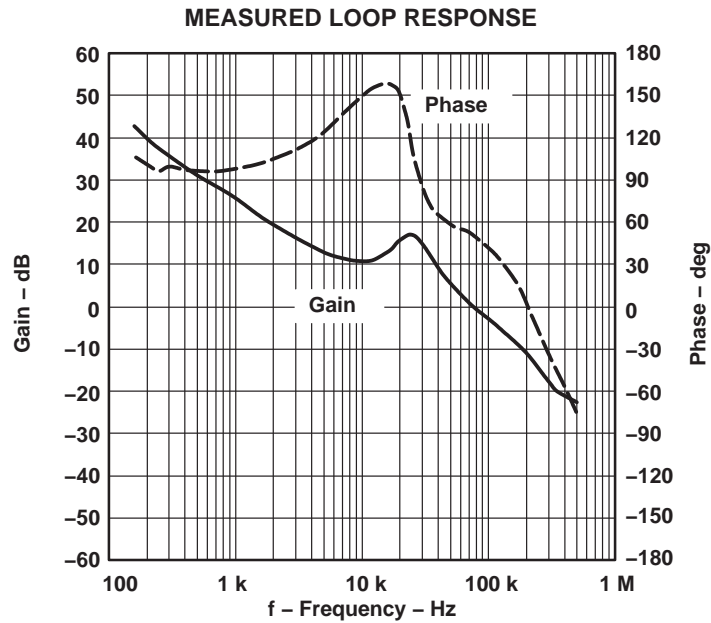
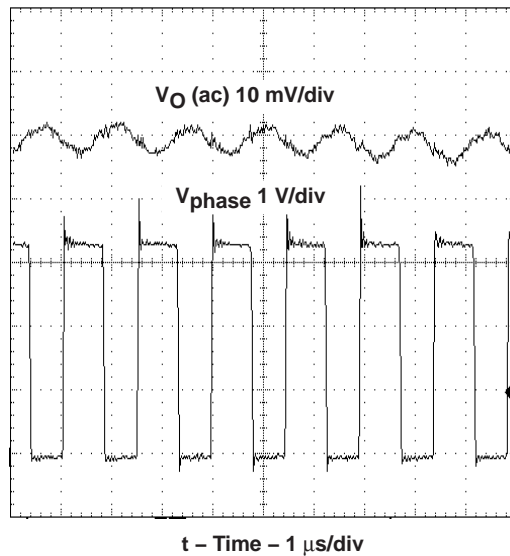

Figure 2–8. Measured Loop Response, TPS54980, $V_I = 4$ 

2.7 Output Voltage Ripple

The TPS54980EVM-022 output voltage ripple is shown in Figure 2–9. The input voltage is 3.3 V for the TPS54980. Output current is the rated full load of 9 A. Voltage is measured directly across output capacitors.

Figure 2–9. Measured Output Voltage Ripple, TPS54980



2.8 Input Voltage Ripple

The TPS54980EVM-022 output voltage ripple is shown in Figure 2-10. The input voltage is 3.3 V for the TPS54980. Output current for each device is the rated full load of 9 A.

Figure 2-10. Input Voltage Ripple, TPS54980

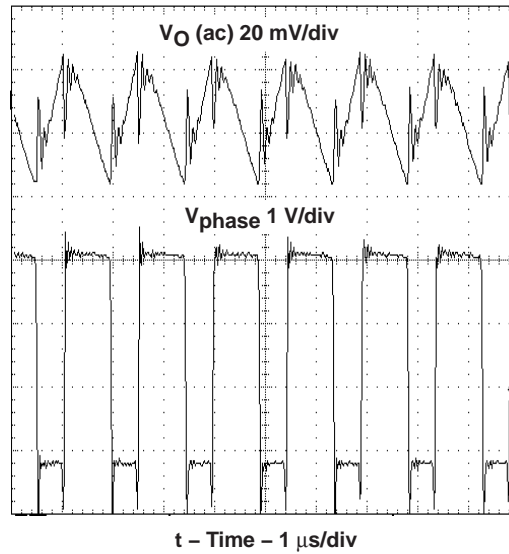

2.9 Power Up and Down

The TPS54980 regulator provides different modes for power up and power down sequencing of the core and I/O voltages. By selecting different ratios for the resistor divider R6/R7 (see Figure 4–1), the slope of the core voltage during power up and down can be set equal to, higher than, or lower than the slope of the I/O voltage. If the resistors $R6 = R1$ and $R7 = R2$, then the core voltage tracks the I/O voltage. The start up voltage waveform of the TPS54980EVM-022 for this condition is shown in Figure 2–11. The waveform shows that the core voltage regulator tracks the output of the I/O regulator until the core regulator reaches its nominal 1.8-V level. After that, the core regulator starts to regulate its output at the preset 1.8-V level. The I/O regulator continues its ramp up until the voltage reaches the nominal 3.3-V level. The output voltage waveforms during power up do not depend on load currents. The output voltage waveforms are powered up by asserting the ENABLE signal while the input voltage is already applied.

Figure 2–11. Power Up with Tracking

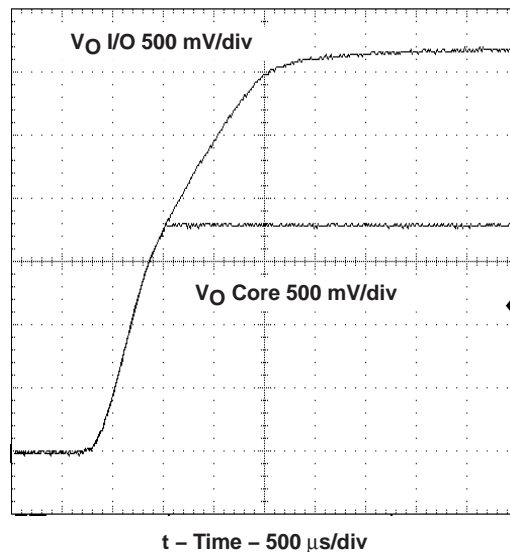

The power down waveform is shown in Figure 2–12. During power down, the output voltage fall time is defined by the output capacitance and load resistance. In this case the I/O output load resistance has been set to 20 Ω and the core output load resistance set to 1 Ω . With the I/O output voltage falling with a slew rate of about 1.25 V/ms, there is essentially no difference between the core voltage and I/O voltage.

Figure 2–12. Power Down With Tracking

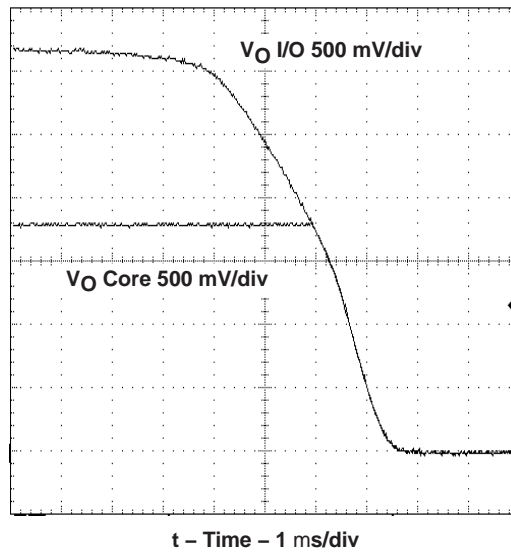

The TPS54980EVM-022 EVM provides the ability to change the slew rate of the output voltage of the core regulator by using jumper JP2 (see schematic in Figure 4–1). If jumper JP2 is set so that R8 is connected in parallel to R7, ratiometric power sequencing is implemented. For ratiometric sequencing, the following condition must be met: if $R6 = 10\text{ k}\Omega$ then $R8 \parallel R7 = (R7 \times 0.891)/(V_{I/O} - 0.891)$. In this case, the I/O and core voltages reach their nominal values at the same time. The waveforms for ratiometric power up and down are shown in Figure 2–13 and Figure 2–14.

Figure 2–13. Power Up With Ratiometric Sequencing

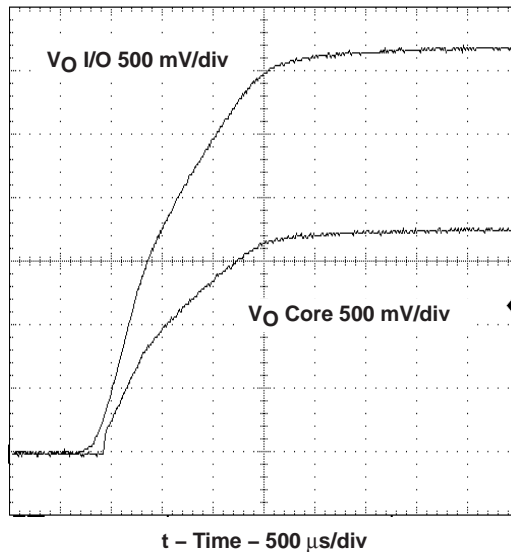
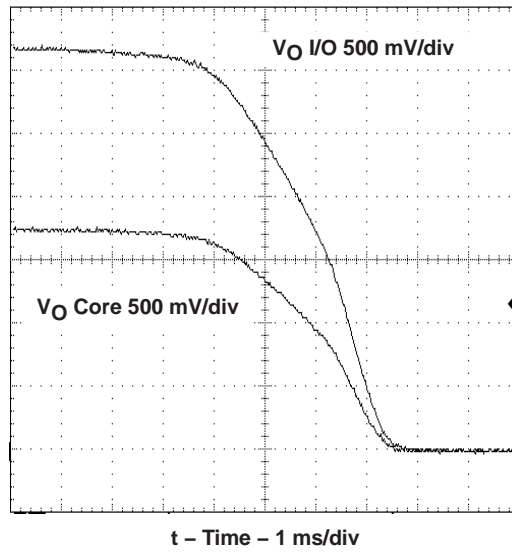

Figure 2–14. Power Down With Ratiometric Sequencing



If jumper JP2 is set so that R8 is connected in parallel to R6, the core voltage rises first during power up and falls second during power down. The waveforms with this type of sequencing are shown in Figure 2–15 and Figure 2–16.

Figure 2–15. Power Up With Core Voltage Rising First

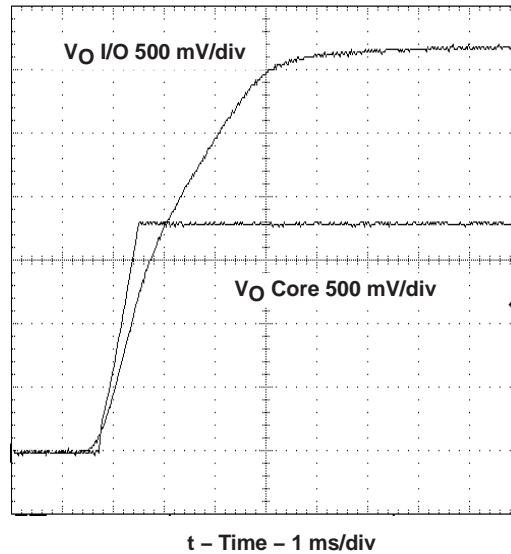
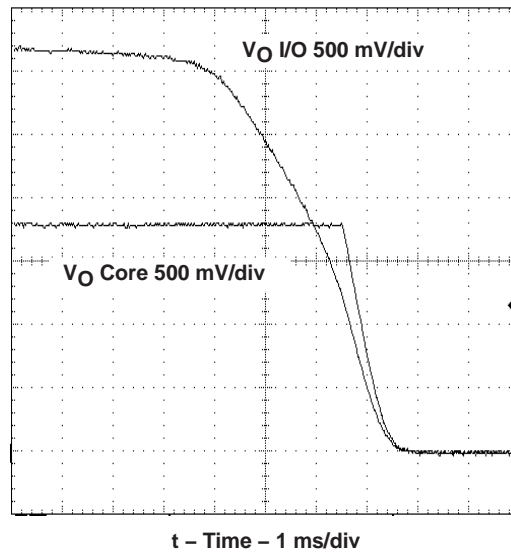

Figure 2-16. Power Up With Core Voltage Falling Second



Board Layout

This chapter provides a description of the TPS54980EVM-022 board layout and layer illustrations.

Topic	Page
3.1 Layout	3-2

3.1 Layout

The board layout for the TPS54980EVM-022 is shown in Figure 3-1 through Figure 3-6. The topside layer of the TPS54980EVM-022 is laid out in a manner typical of a user application. The top and bottom layers are 1.5-oz. copper, while the two internal ground plane layers are 1-oz. copper.

The top layer contains the main power traces for V_I , V_O , and V_{phase} . Also on the top layer are connections for the remaining pins of the TPS54980 and a large area filled with ground. The bottom layer contains ground and some signal routing. The top and bottom ground traces are connected with multiple vias placed around the board including 12 directly under the TPS54980 device to provide a thermal path from the PowerPAD™ land to ground.

The input decoupling capacitors (C5, C9, and C19), bias decoupling capacitor (C4), and bootstrap capacitor (C3) are all located as close to the IC as possible. In addition, the compensation components are also kept close to the IC. The compensation circuit ties to the output voltage at the point of regulation, adjacent to the high frequency bypass output capacitor.

Figure 3-1. Top-Side Layout

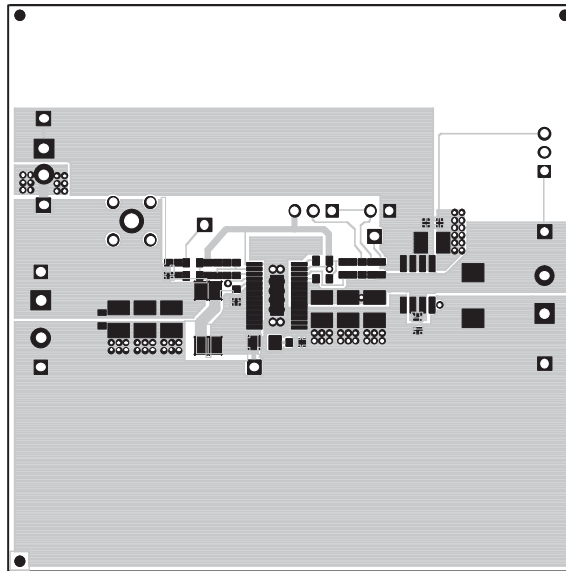

Figure 3–2. Internal Layer 2

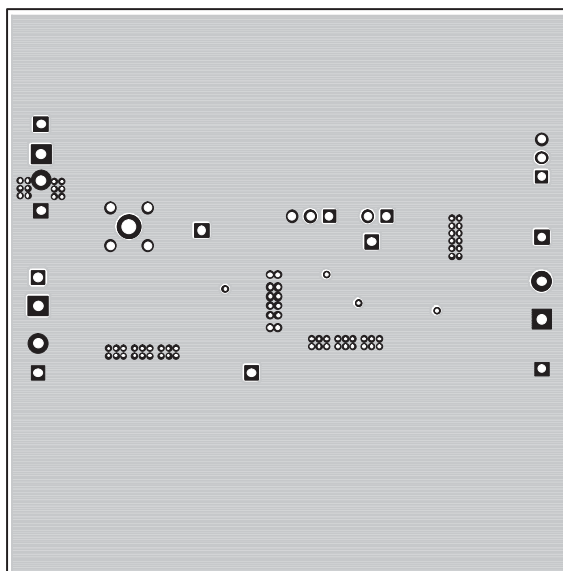
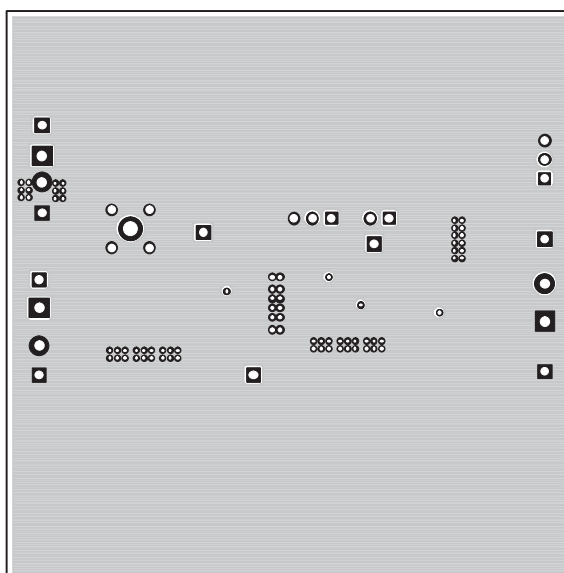

Figure 3–3. Internal Layer 3



Schematic and Bill of Materials

The TPS54980EVM-022 schematic and bill of materials are presented in this chapter.

Topic	Page
4.1 Schematic	4-2
4.2 Bill of Materials	4-3

4.1 Schematic

The schematic for the TPS54980EVM-022 is shown in Figure 4-1.

Figure 4-1. TPS54980EVM-022 Schematic

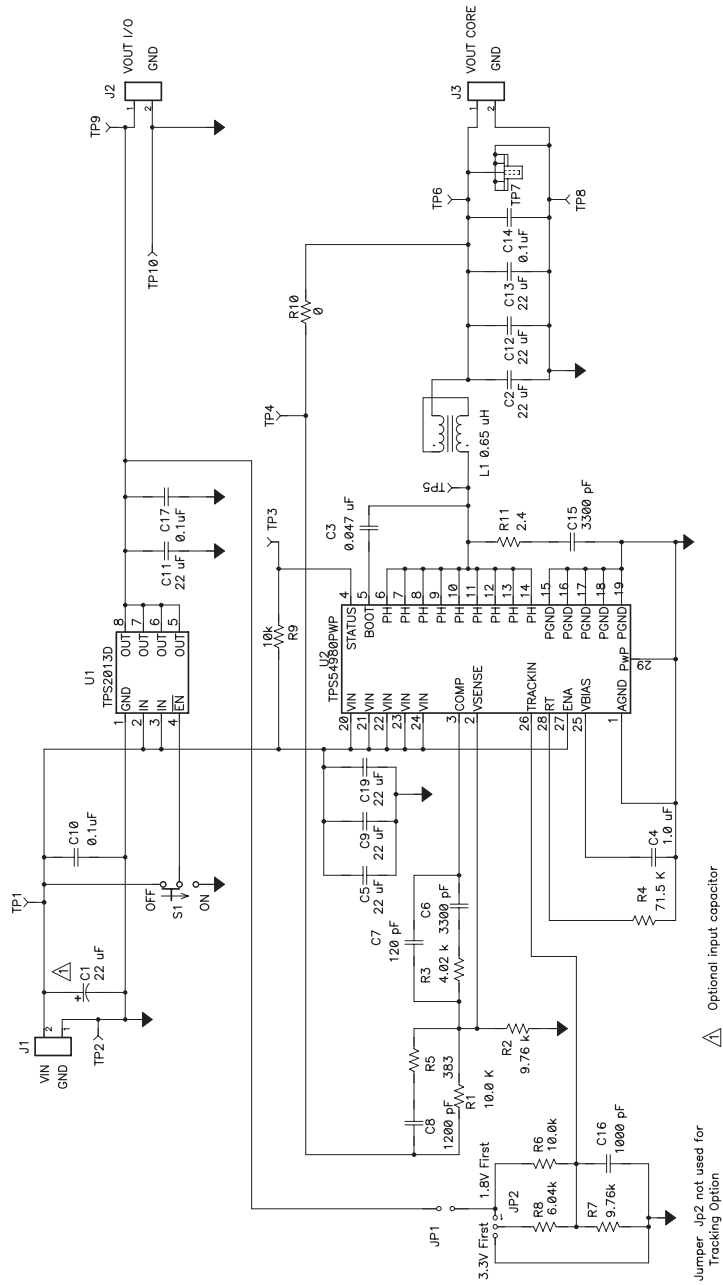

4.2 Bill of Materials

The bill of materials for the TPS54980EVM-022 is listed in Table 4-1.

Table 4-1. TPS54980EVM-022 Bill of Materials

Count	Ref Des	Description	Size	MFR	Part Number
–	C1	Capacitor, POSCAP, 220 μ F, 10 V, 45 m Ω , 20%	7343 (D)	Sanyo	10TPB220M
3	C10, C14, C17	Capacitor, ceramic, 0.1 μ F, 25 V, X7R, 10%	603	Std	Std
1	C16	Capacitor, ceramic, 1000 pF, 25 V, X7R, 10%	603	Std	Std
7	C2, C5, C9, C11, C12, C13, C19	Capacitor, ceramic, 22 μ F, 6.3 V, X5R, 20%	1210	Taiyo Yuden	JMK325BJ226MN
1	C3	Capacitor, ceramic, 0.047 μ F, 25 V, X7R, 10%	603	Std	Std
1	C4	Capacitor, ceramic, 1.0 μ F, 10 V, X5R, 20%	603	Std	Std
2	C6, C15	Capacitor, ceramic, 3300 pF, 50 V, X7R, 10%	603	Std	Std
1	C7	Capacitor, ceramic, 120 pF, 50 V, NPO, 5%	603	Std	Std
1	C8	Capacitor, ceramic, 1200 pF, 50 V, X7R, 10%	603	Std	Std
2	J1, J3	Terminal block, 2 pin, 15 A, 5,1 mm	148830	OST	ED1609
1	J2	Terminal block, 2 pin, 6 A, 3,5 mm	75525	OST	ED1514
1	JP1	Header, 2 pin, 100 mil spacing, (36-pin strip)	0.100 \times 2"	Sullins	PTC36SAAN
1	JP2	Header, 3 pin, 100 mil spacing, (36-pin strip)	0.100 \times 3"	Sullins	PTC36SAAN
2	—	Shunt, 100 mil, black	0.100	3M	929950-00
1	L1	Inductor, 0.65 μ H, 12 A	0.340 \times 0.250	Pulse	PA0277
1	R1	Resistor, chip, 10.0 k Ω , 1/16 W, 1%	603	Std	Std
1	R10	Resistor, chip, 0 Ω , 1/16 W, 1%	603	Std	Std
1	R11	Resistor, chip, 2.4 Ω , 1/8 W, 1%	1206	Std	Std
2	R2, R7	Resistor, chip, 9.76 k Ω , 1/16 W, 1%	603	Std	Std
1	R3	Resistor, chip, 4.02 k Ω , 1/16 W, 1%	603	Std	Std
1	F4	Resistor, chip, 71.5 k Ω , 1/16 W, 1%	603	Std	Std
1	R5	Resistor, chip, 383 Ω , 1/16 W, 1%	603	Std	Std
1	R6	Resistor, chip, 10.0 k Ω , 1/16 W, 1%	603	Std	Std
1	R8	Resistor, chip, 6.04 k Ω , 1/16 W, 1%	603	Std	Std
1	R9	Resistor, chip, 10 k Ω , 1/16 W, 1%	603	Std	Std
1	S1	Switch, 1P2T, slide, PC mount, 200 mA	0.46 \times 0.16	E_Switch	EQ1218
5	TP1, TP3, TP4, TP5, TP6	Test point, red, 1 mm	0.038", 6400"	Farnell	240-345
1	TP10	Test point, black, 1 mm	0.038	Farnell	240-333
2	TP2, TP8	Test point, black, 1 mm	0.038", 6400"	Farnell	240-333

Bill of Materials

Count	Ref Des	Description	Size	MFR	Part Number
1	TP7	Adaptor, 3,5 mm probe clip (or 131-5031-00)	72900	Tektronix	131-4244-00
1	TP9	Test point, red, 1 mm	0.038	Farnell	240-345
1	U1	IC, high-side power distribution SW with current limit	SO8	TI	TPS201xD
1	U2	IC, tracking synchronous PWM switcher	PWP28	TI	TPS54980PWP
1	—	PCB, 3 in. × 3 in. × 0.062 in.		Any	HPA022

- Notes:**
- 1) These assemblies are ESD sensitive, ESD precautions should be observed.
 - 2) These assemblies must be clean and free from flux and all contaminants, Use of no clean flux is not acceptable.
 - 3) These assemblies must comply with workmanship standards IPC-A-610 Class 2.
 - 4) Reference designators marked with an asterisk (**) cannot be substituted. All other components can be substituted with equivalent manufacturers components.