

WR-28 Standard Gain Horn with 10 dBi gain, 2.92mm Female connector

## Technical Data Sheet

**PEWAN028-10KF**

### Mechanical Specifications

#### Size

Length	1.403 in [35.64 mm]
Width	0.75 in [19.05 mm]
Height	0.75 in [19.05 mm]
Weight	0.338 lbs [153.31 g]

#### RF Connector

Type	2.92mm Female
------	---------------

#### Waveguide Interface

Waveguide Size	WR-28
----------------	-------

### Environmental Specifications

**Compliance Certifications** (see [product page](#) for current document)

### Plotted and Other Data

Notes:

Click the following link (or enter part number in "SEARCH" on website) to obtain additional part information including price, inventory and certifications: [WR-28 Standard Gain Horn with 10 dBi gain, 2.92mm Female connector PEWAN028-10KF](#)

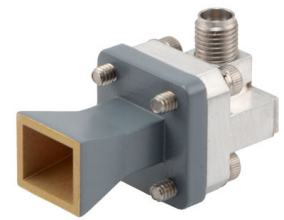

WR-28 Standard Gain Horn with 10 dBi gain, 2.92mm Female connector

**Technical Data Sheet**

**PEWAN028-10KF**

Typical Performance Data

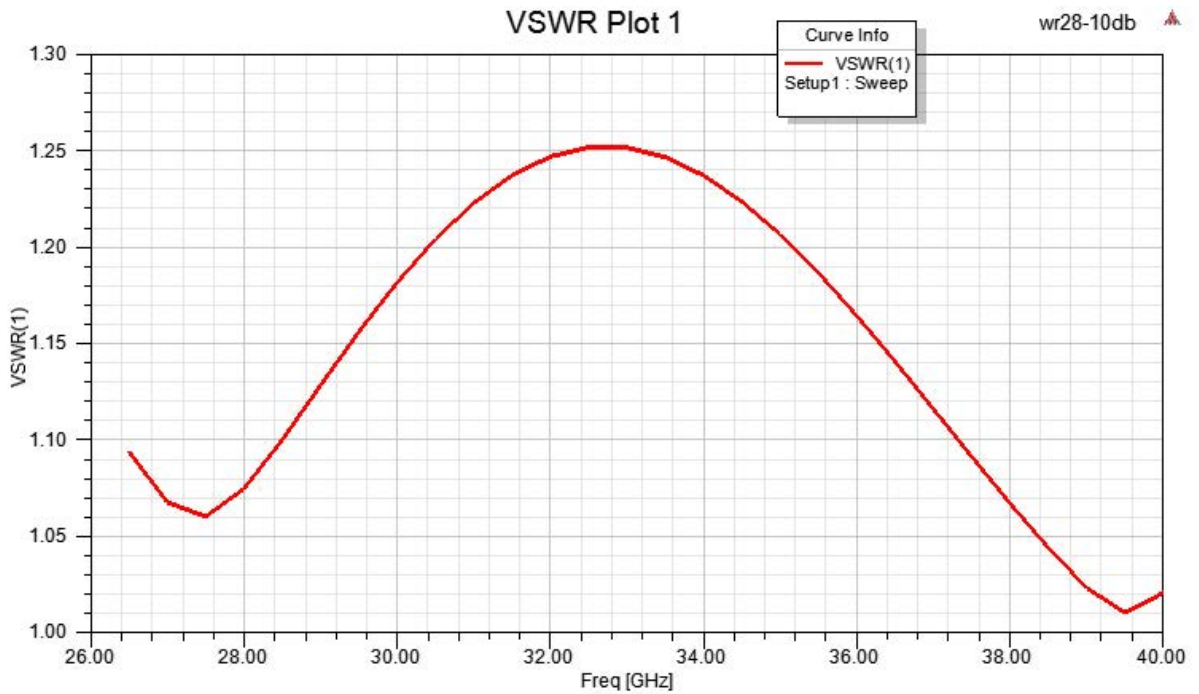

Click the following link (or enter part number in "SEARCH" on website) to obtain additional part information including price, inventory and certifications: [WR-28 Standard Gain Horn with 10 dBi gain, 2.92mm Female connector PEWAN028-10KF](#)

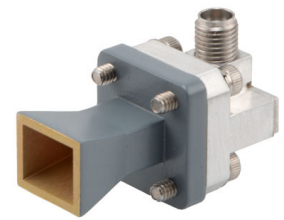

WR-28 Standard Gain Horn with 10 dBi gain, 2.92mm Female connector

**Technical Data Sheet**

**PEWAN028-10KF**

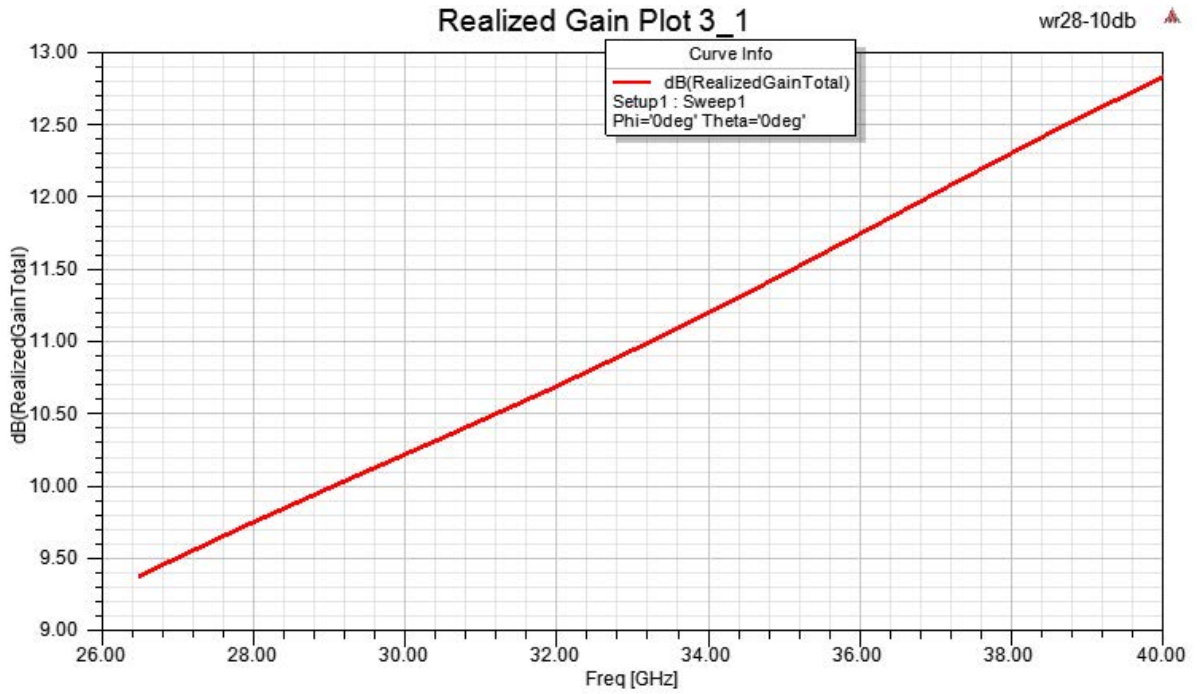

Click the following link (or enter part number in "SEARCH" on website) to obtain additional part information including price, inventory and certifications: [WR-28 Standard Gain Horn with 10 dBi gain, 2.92mm Female connector PEWAN028-10KF](#)

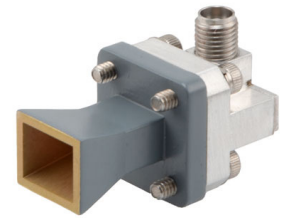

WR-28 Standard Gain Horn with 10 dBi gain, 2.92mm Female connector

**Technical Data Sheet**

**PEWAN028-10KF**

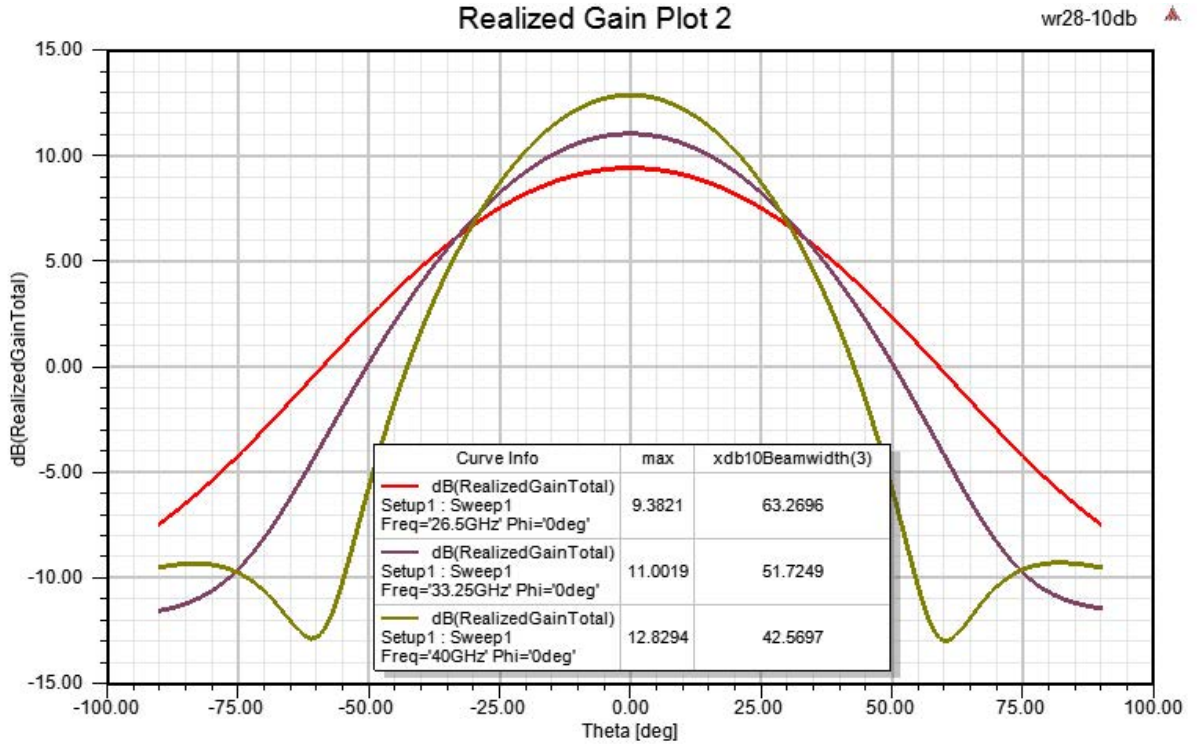

Click the following link (or enter part number in "SEARCH" on website) to obtain additional part information including price, inventory and certifications: [WR-28 Standard Gain Horn with 10 dBi gain, 2.92mm Female connector PEWAN028-10KF](#)

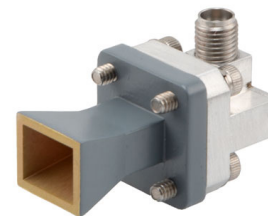

WR-28 Standard Gain Horn with 10 dBi gain, 2.92mm Female connector

**Technical Data Sheet**

**PEWAN028-10KF**

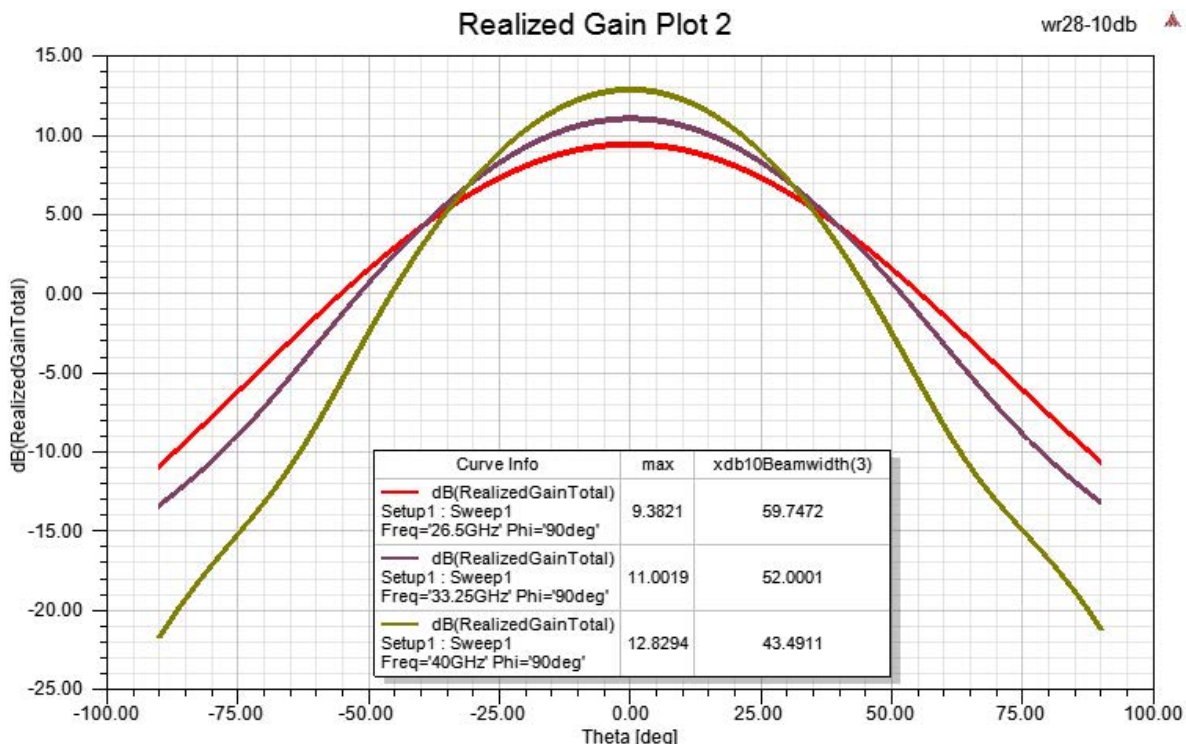

WR-28 Standard Gain Horn with 10 dBi gain, 2.92mm Female connector from Pasternack Enterprises has same day shipment for domestic and International orders. Our RF, microwave and millimeter wave products maintain a 99.4% availability and are part of the broadest selection in the industry.

Click the following link (or enter part number in "SEARCH" on website) to obtain additional part information including price, inventory and certifications: [WR-28 Standard Gain Horn with 10 dBi gain, 2.92mm Female connector PEWAN028-10KF](#)

URL:

The information contained in this document is accurate to the best of our knowledge and representative of the part described herein. It may be necessary to make modifications to the part and/or the documentation of the part, in order to implement improvements. Pasternack reserves the right to make such changes as required. Unless otherwise stated, all specifications are nominal. Pasternack does not make any representation or warranty regarding the suitability of the part described herein for any particular purpose, and Pasternack does not assume any liability arising out of the use of any part or documentation.



# PEWAN028-10KF CAD Drawing

WR-28 Standard Gain Horn with 10 dBi gain, 2.92mm Female connector

REVISIONS			
REV.	DESCRIPTION	DATE	APPROVED
A	INITIAL RELEASE	10/04/2021	KHIETPAS

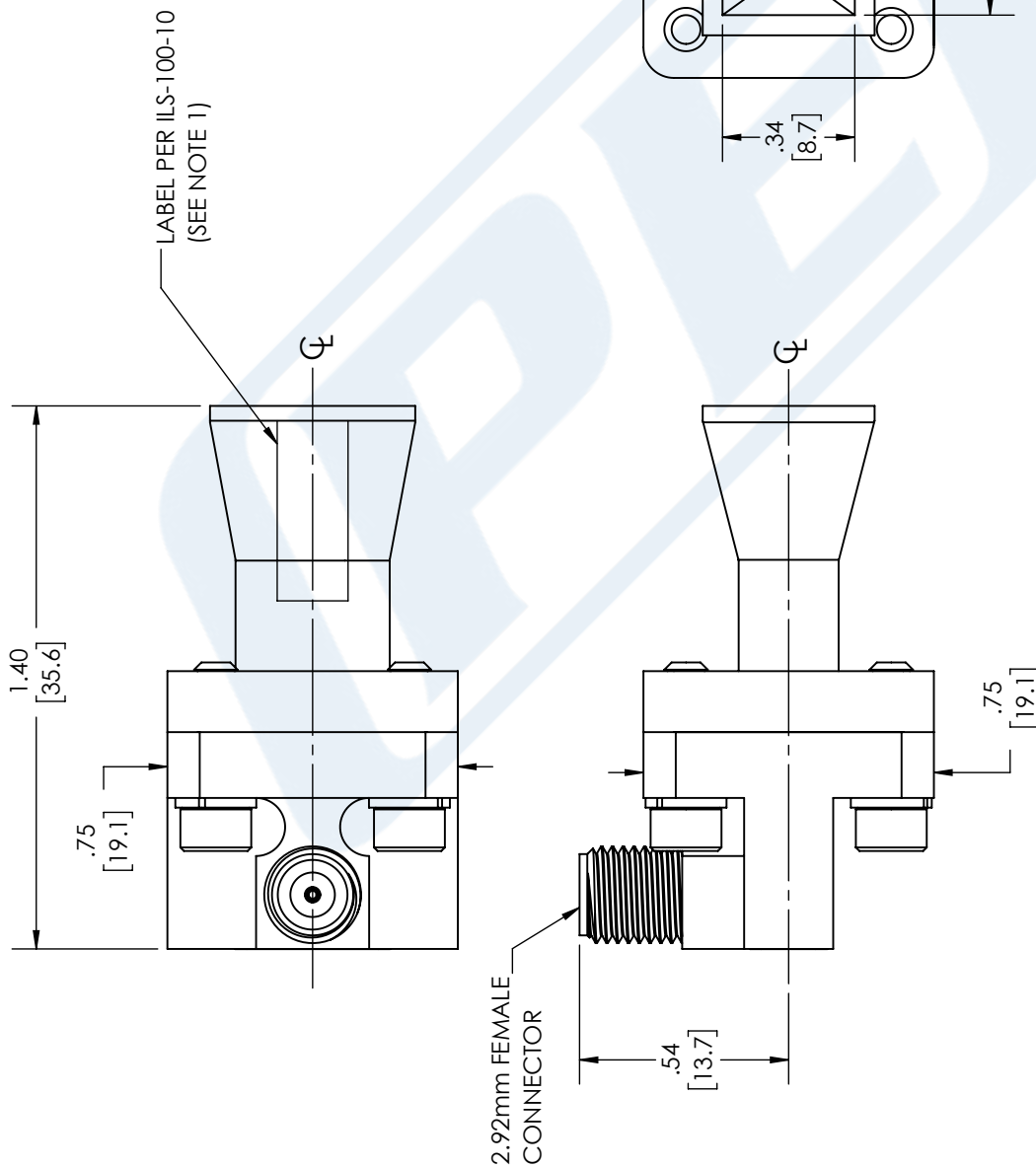

**PE PASTERNAK**  
an INFINITI® brand

Pasternack Enterprises, Inc.  
P. O. Box 16759, Irvine, CA 92623.  
Phone: 1.949.261.1920 | 1.866.727.8376  
Fax: 1.949.261.7451  
Website: www.pasternack.com  
E-mail: sales@pasternack.com

THIRD-ANGLE PROJECTION

THE INFORMATION AND DESIGN IN THIS DOCUMENT IS THE PROPERTY OF PASTERNAK CORPORATION. ALL RIGHTS RESERVED.

SHEET 1 OF 1

SCALE N/A

REV A

ITEM NO. PEWAN028-10KF

DRAWN BY BPUCHASKI

CAGE CODE 53919

UNLESS OTHERWISE SPECIFIED LEADING DIMENSIONS ARE INCHES DIMENSIONS IN [ ] ARE MILLIMETERS

TOLERANCES:

.X = ±.2 [5.08] FRACTIONS ±1/32  
.XX = ±.02 [.51] ±.005 [.13] ANGLES ± 1°  
.XXX = ±.005 [.13]

CABLE LENGTH (L), TOLERANCES:  
L ≤ 12 [305] = +1 [25] / -0  
12 [305] < L ≤ 60 [1524] = +2 [51] / -0  
60 [1524] < L ≤ 120 [3048] = +4 [102] / -0  
120 [3048] < L ≤ 300 [7620] = +6 [152] / -0  
300 [7620] < L = +5% / -0

ALL DIMENSIONS SHOWN ARE FOR REFERENCE ONLY.

**NOTES:**  
1. LABEL PER ILS-100-10 (FOR INTERNAL REFERENCE ONLY)  
LABEL LOCATION FOR REFERENCE ONLY

THESE COMMODITIES, TECHNOLOGY OR SOFTWARE WERE EXPORTED FROM THE UNITED STATES IN ACCORDANCE WITH THE EXPORT ADMINISTRATION REGULATIONS. DIVERSION CONTRARY TO U.S. LAW PROHIBITED.